

IG LIGHTING 

IG LIGHTING 

2020-2021

IG LIGHTING 

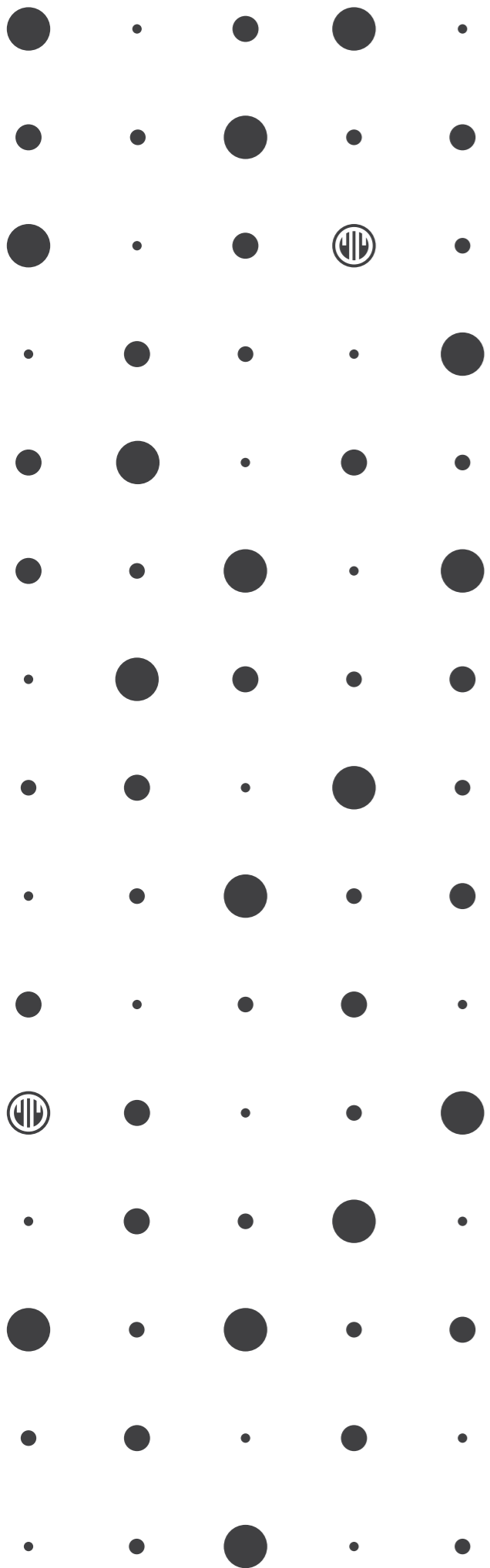

正面 10cm 拉页

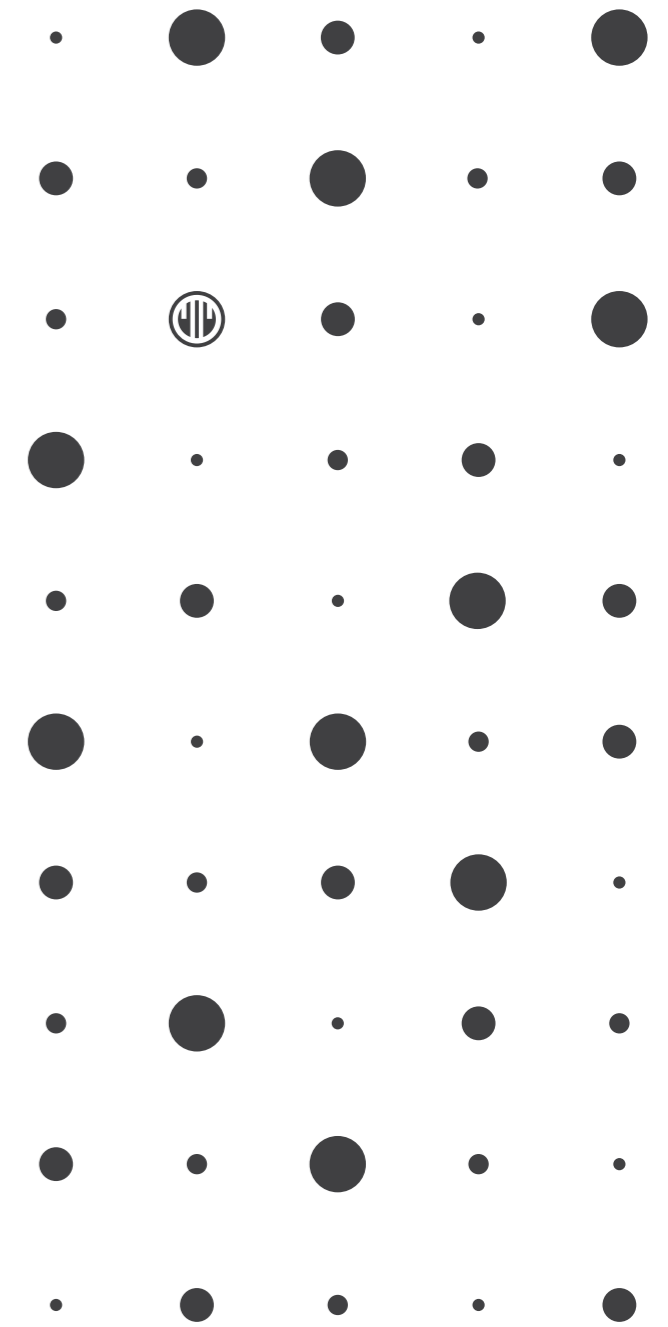

背面 10cm 拉页

声明：本书所列之产品外观及技术参数仅供参考，我司保留最终解释权，如产品外观及参数有更改，我司保留不预先通告之权利。如有任何疑问，请致电客服热线：400-865-2016

Declaration: The technical information and appearance of products appearing in this catalogue is indicative only and subject to revision. IG reserves the right to revise information without notice.

**IG LIGHTING**   
广东爱奇光电科技有限公司 IG LIGHTING  
地址：广东省中山市小榄镇工业大道北 22 号  
<http://www.ig-lighting.com>  
电话：400-865-2016





締 造 光 影 艺 术  
DESIGN WITH LIGHTING



无概念·无道理

因为创意  
才会锐变  
每一次改变  
是为每一束  
最专业的灯光



广东爱奇光电科技有限公司，英文名称“IG Lighting company profile”，简称“爱奇光电”“IG Lighting”“IG 照明”，创立于2016年，是一家秉承科技、智能、创新、服务至上的理念，缔造光影艺术，将生活与工业美感结合，集LED绿色照明产品研发、生产、销售和服务于一体的专业照明公司。

定位在“Design with Lighting”“缔造光影艺术”的IG照明，围绕用户、市场需求，开创性的提出黑光、藏光、凝光、滤光，四重防眩理念，助力打造舒适柔光美学空间，其中AKARI阿卡丽系列已成为舒适柔光美学的代表，产品广泛应用于酒店，别墅、会所、商场等领域，以出色的照明空间表现，深受用户及设计师的认可及赞誉。

爱奇光电产品涵盖酒店、店铺、别墅、办公四大门类照明设计需求，针对性提供产品方案，形成了包括天花射灯、洗墙灯、筒灯、导轨灯、办公灯、支架灯、线型灯带、户外灯等多个专业产品品类，用以更专业服务专业的理念打造专业的服务系统。爱奇光电，用爱创造神奇！

Guangdong IG Optoelectronic Technology Co., Ltd., referred to as "IG Lighting", was founded in 2016, is a scientific and technological, intelligent, innovative, service-oriented concept, create the art of lighting, the combination of life and industry aesthetic, set LED green lighting product research and development, production, Sales and service in one of the professional lighting company.

IG Optonics has been focusing on the hotel, store, restaurant, office lighting design requirements, targeted to provide product solutions, including led ceiling spot light, wall wash lamp, downlight, led track light, office lighting, Linear lamp, outdoor light and other professional product categories, with professional system services won deep customer praise.

Positioning in "Design with Lighting", service for the user, according to market demand, create IG custom service, provide users with high quality lighting products and professional lighting design services, To provide customers with "professional customized lighting" to achieve IG lighting in the field of commercial lighting extremely professional brand status.

# PROJECT

## Hotel



北京中关村经济论坛项目

南平雅格大酒店

杭州绿城办公楼

江苏省农业银行网点战略服务品牌

无锡瑞延西郊酒店

深圳装饰集团总部办公楼

重庆西南证券大厦

上海世贸艾美酒店

喜鹊家具办公楼

东莞浦发银行

杭州艺栖酒店

前海博商总部学院

芜湖丽景希尔顿酒店

山水间酒店 全国连锁

成都第六空间

西安欢朋希尔顿酒店

纽宾凯精装公寓 / 酒店

天鹅童话美容院连锁店

北京中国尊中信大厦

水贝亚朵酒店

杭州苑苑美容美发连锁

阳光城地产

莲花山庄度假酒店

瑞辛·咖啡店连锁店

广州广发证券大厦

美硕酒店 连锁

世界精酿啤酒·仓连锁

香港中银大厦

天津朝廷水会温泉酒店

威美斯 KTV 连锁

世华帝宝大厦

绵阳宏泰威图酒店

北纬男装品牌连锁店

北京同仁堂 连锁

贵阳裂变广场酒店

香蜜湖九号大院

北京大董餐饮总部基地

西子里酒店

曦城别墅

吉利汽车生产基地

普陀山雷迪森庄园酒店

江阴市和院别墅

新隆嘉新零售超市连锁

杭州西溪湿地酒店

WARSAW 服装店

苏州丰隆城市中心

崇明岛酒店

大喜牛餐饮管理

福建·悦武夷茶文化美学酒店

北京生命科学院办公楼

香积厨餐饮连锁

.....

## Catering



## Shop



## Supermarket



## Office





## QUICK INDEX

快速索引









AKARI Series	001
Stretch Series 拉伸天花灯	106
Fuma Series 飞马	114
Fenghua Series 风华	120
Funline Series 飞凌	136
Phantom Series 魅影	158
Katz Series 卡兹射灯	174
King Series 黑金	184
PT Series 白金	226
AK75	234
Mini Series 微光	240
Rout Series 劳特	250
Katz Series 卡兹轨道灯	286
Camera Series 照相机	298
Trojan people II Series 木马人	304
Freeman Series 自由人	310
Magnetically absorbent lamp 磁吸线型灯	316
Office light 办公教育灯	328
Office linear light 办公线型灯	340
Light belt 灯带	353
T5 / T8	359
Indoor light 室内灯	363
Outdoor light 户外灯	369
Cabinet light 橱柜灯	379

AKARI Series / 0655

Product	Model	Power	CCT	Beam angle	Cutout	Size	Page
	IG-XQ605506 01- 反光杯 IG-XQ605507 01- 透镜款	6W 7W	2700K/3000K/4000K	15°/24°/36° 10°/15°/24°/36°/50°*	Φ55mm	Φ65x75mm Φ61.5x75mm	016
	IG-XQ605506 02- 反光杯 IG-XQ605507 02- 透镜款	6W 7W	2700K/3000K/4000K	15°/24°/36° 10°/15°/24°/36°/50°*	Φ55mm	Φ65x70mm Φ61.5x70mm	017
	IG-XQ605506 03- 反光杯 IG-XQ605507 03- 透镜款	6W 7W	2700K/3000K/4000K	15°/24°/36° 10°/15°/24°/36°/50°*	Φ55mm	Φ65x75mm Φ61.5x75mm	018
	IG-XQ605506 04- 反光杯 IG-XQ605507 04- 透镜款	6W 7W	2700K/3000K/4000K	15°/24°/36° 10°/15°/24°/36°/50°*	Φ55mm	Φ65x70mm Φ61.5x70mm	019
	IG-XQ606006 01- 反光杯 IG-XQ606007 01- 透镜款	6W 7W	2700K/3000K/4000K	15°/24°/36° 10°/15°/24°/36°/50°*	Φ60mm	Φ86x76mm	021
	IG-XQ606006 02- 反光杯 IG-XQ606007 02- 透镜款	6W 7W	2700K/3000K/4000K	15°/24°/36° 10°/15°/24°/36°/50°*	Φ60mm	Φ86x70mm	022
	IG-XQ606006 03- 反光杯 IG-XQ606007 03- 透镜款	6W 7W	2700K/3000K/4000K	15°/24°/36° 10°/15°/24°/36°/50°*	Φ60mm	Φ86x76mm	023
	IG-XQ606006 04- 反光杯 IG-XQ606007 04- 透镜款	6W 7W	2700K/3000K/4000K	15°/24°/36° 10°/15°/24°/36°/50°*	Φ60mm	Φ86x70mm	024

\*代表需定制







AKARI Series / 1275

Product	Model	Power	CCT	Beam angle	Cutout	Size	Page
	IG-XQ607508 01- 反光杯 IG-XQ607508 01- 透镜款 IG-XQ607512 01- 反光杯 IG-XQ607512 01- 透镜款	8W 8W 12W 12W	2700K/3000K/4000K	15°/24°/36° 10°/12°/15°/24°/36°/60°* 15°/24°/36° 10°/12°/15°/24°/36°/60°*	Φ75mm	Φ85x110mm Φ79x110mm	036
	IG-XQ607508 02- 反光杯 IG-XQ607508 02- 透镜款 IG-XQ607512 02- 反光杯 IG-XQ607512 02- 透镜款	8W 8W 12W 12W	2700K/3000K/4000K	15°/24°/36° 10°/12°/15°/24°/36°/60°* 15°/24°/36° 10°/12°/15°/24°/36°/60°*	Φ75mm	Φ85x105mm Φ79x105mm	037
	IG-XQ607508 03- 反光杯 IG-XQ607508 03- 透镜款 IG-XQ607512 03- 反光杯 IG-XQ607512 03- 透镜款	8W 8W 12W 12W	2700K/3000K/4000K	15°/24°/36° 10°/12°/15°/24°/36°/60°* 15°/24°/36° 10°/12°/15°/24°/36°/60°*	Φ75mm	Φ85x110mm Φ79x110mm	038
	IG-XQ607508 04- 反光杯 IG-XQ607508 04- 透镜款 IG-XQ607512 04- 反光杯 IG-XQ607512 04- 透镜款	8W 8W 12W 12W	2700K/3000K/4000K	15°/24°/36° 10°/12°/15°/24°/36°/60°* 15°/24°/36° 10°/12°/15°/24°/36°/60°*	Φ75mm	Φ85x105mm Φ79x105mm	039
	IG-XQ608008 01- 反光杯 IG-XQ608008 01- 透镜款 IG-XQ608012 01- 反光杯 IG-XQ608012 01- 透镜款	8W 8W 12W 12W	2700K/3000K/4000K	15°/24°/36° 10°/12°/15°/24°/36°/60°* 15°/24°/36° 10°/12°/15°/24°/36°/60°*	Φ80mm	Φ114x110mm	041
	IG-XQ608008 02- 反光杯 IG-XQ608008 02- 透镜款 IG-XQ608012 02- 反光杯 IG-XQ608012 02- 透镜款	8W 8W 12W 12W	2700K/3000K/4000K	15°/24°/36° 10°/12°/15°/24°/36°/60°* 15°/24°/36° 10°/12°/15°/24°/36°/60°*	Φ80mm	Φ114x105mm	042
	IG-XQ608008 03- 反光杯 IG-XQ608008 03- 透镜款 IG-XQ608012 03- 反光杯 IG-XQ608012 03- 透镜款	8W 8W 12W 12W	2700K/3000K/4000K	15°/24°/36° 10°/12°/15°/24°/36°/60°* 15°/24°/36° 10°/12°/15°/24°/36°/60°*	Φ80mm	Φ114x110mm	043
	IG-XQ608008 04- 反光杯 IG-XQ608008 04- 透镜款 IG-XQ608012 04- 反光杯 IG-XQ608012 04- 透镜款	8W 8W 12W 12W	2700K/3000K/4000K	15°/24°/36° 10°/12°/15°/24°/36°/60°* 15°/24°/36° 10°/12°/15°/24°/36°/60°*	Φ80mm	Φ114x105mm	044



\*代表需定制



# AKARI Series / 1275







Product	Model	Power	CCT	Beam angle	Cutout	Size	Page
	IG-TH606508 01 IG-TH606512 01	8W 12W	2700K/3000K/4000K	15°/24°/36°	Φ65mm	Φ80x88mm	045
	IG-TH606508 04 IG-TH606512 04	8W 12W	2700K/3000K/4000K	15°/24°/36°	Φ65mm	Φ77x85mm	046
	IG-TH607508 02 IG-TH607512 02	8W 12W	2700K/3000K/4000K	15°/24°/36°	Φ75mm	Φ86x96mm	047
	IG-TH607508 03 IG-TH607512 03	8W 12W	2700K/3000K/4000K	15°/24°/36°	Φ75mm	Φ86x99mm	048
	IG-GS609508 01 IG-GS609512 01	8W 12W	2700K/3000K/4000K	15°/24°/36°	95x95mm	100x100x108.5mm	049
	IG-GS609516 02 IG-GS609524 02	2x8W 2x12W	2700K/3000K/4000K	15°/24°/36°	175x95mm	185x100x108.5mm	050

# AKARI Series / 2595



Product	Model	Power	CCT	Beam angle	Cutout	Size	Page
	IG-XQ609512 01- 反光杯	12W		15°/24°/38°/60°		Φ111x110mm	060
	IG-XQ609515 01- 反光杯	15W		15°/24°/38°/60°		Φ111x110mm	
	IG-XQ609520 01- 反光杯	20W	2700K/3000K/4000K	15°/24°/38°/60°	Φ95mm	Φ111x140mm	
	IG-XQ609520 01- 透镜款	20W		12°/15°/24°/36°/60°*		Φ111x140mm	
	IG-XQ609525 01- 反光杯	25W		15°/24°/38°/60°		Φ111x140mm	
	IG-XQ609512 02- 反光杯	12W		15°/24°/38°/60°		Φ111x110mm	061
	IG-XQ609515 02- 反光杯	15W		15°/24°/38°/60°		Φ111x110mm	
	IG-XQ609520 02- 反光杯	20W	2700K/3000K/4000K	15°/24°/38°/60°	Φ95mm	Φ111x133mm	
	IG-XQ609520 02- 透镜款	20W		12°/15°/24°/36°/60°*		Φ111x133mm	
	IG-XQ609525 02- 反光杯	25W		15°/24°/38°/60°		Φ111x133mm	

\*代表需定制

# AKARI Series / 凌

Product	Model	Power	CCT	Beam angle	Cutout	Size	Page
	IG-TD611015	15W					072
	IG-TD611020	20W	3000K/4000K	15°/24°/38°/60°	110x110mm	124x124x155mm	
	IG-TD611025	25W					
	IG-TD612015	15W					073
	IG-TD612020	20W	3000K/4000K	15°/24°/38°/60°	120x120mm	119x119x155mm	
	IG-TD612025	25W					
	IG-TD611008	8W					075
	IG-TD611012	12W	3000K/4000K	15°/24°/38°/60°	110x110mm	124x124x120mm	
	IG-TD612008	8W					076
	IG-TD612012	12W	3000K/4000K	15°/24°/38°/60°	120x120mm	119x119x125mm	
	IG-MT010415	15W					077
	IG-MT010420	20W	3000K/4000K	15°/24°/38°/60°	103.5x103.5x185mm	明装式	
	IG-MT010425	25W					
	IG-MT020430	2x15W					078
	IG-MT020440	2x20W	3000K/4000K	15°/24°/38°/60°	204x103.5x185mm	明装式	
	IG-MT020450	2x25W					









# AKARI Series / 华宇

Product	Model	Power	CCT	Beam angle	Cutout	Size	Page
	IG-XQ613030 01	30W					082
	IG-XQ613035 01	35W	3000K/4000K	15°/24°/38°	Φ130mm	Φ145x165mm Φ145x178mm	
	IG-XQ613040 01	40W				Φ145x178mm	
	IG-XQ613030 02	30W					083
	IG-XQ613035 02	35W	3000K/4000K	15°/24°/38°	Φ130mm	Φ145x165mm Φ145x173mm	
	IG-XQ613040 02	40W				Φ145x173mm	

\*代表需定制

# AKARI Series

梦 NEW

Product	Model	Power	CCT	Beam angle	Size	Installation	Page
	IG-MS630027	3x6W+3x3W	3000K/4000K	10°/15°/24°/36°	Φ300x80mm	吊线式 / 嵌入式 / 吸顶式	094
	IG-MS660045	5x6W+5x3W	3000K/4000K	10°/15°/24°/36°	Φ600x80mm	吊线式 / 嵌入式 / 吸顶式	095
	IG-MS690072	8x6W+8x3W	3000K/4000K	10°/15°/24°/36°	Φ900x80mm	吊线式 / 嵌入式 / 吸顶式	096
	IG-MS6120090	10x6W+10x3W	3000K/4000K	10°/15°/24°/36°	Φ1200x80mm	吊线式 / 嵌入式 / 吸顶式	097
	IG-CX660045	/	/	/	Φ600x75mm	吊线式 / 吸顶式	100
	IG-CX690072	/	/	/	Φ900x75mm	吊线式 / 吸顶式	100
	IG-CX6120090	/	/	/	Φ1200x75mm	吊线式 / 吸顶式	100
	IG-CX005007 01	7W	3000K	30°	Φ50x128mm	磁吸	101
	IG-CX003504 02	3.5W	3000K	30°	116x46.5mm	磁吸	102

\*代表需定制



# Stretch Series

拉伸天花板灯

Product	Model	Power	CCT	Beam angle	Cutout	Size	Page
	IG-TH008009 IG-TH010218 IG-TH112025 IG-TH115030	8-12W 15-20W 25-30W 30-35W	3000K/4000K	15°/24°/36°	Φ80mm Φ100mm Φ120mm Φ155mm	Φ90x106mm Φ110x130mm Φ135x160mm Φ165x220mm	108
	IG-TH009812	12W	3000K/4000K	12°/24°/36°	Φ90mm	Φ98x120mm	110
	IG-TH018524	2x12W	3000K/4000K	12°/24°/36°	175x90mm	Φ100x185x120mm	111
	IG-TH027036	3x12W	3000K/4000K	12°/24°/36°	260x90mm	Φ100x270x120mm	112

# Fuma Series





















飞马 NEW

Product	Model	Power	CCT	Beam angle	Cutout	Size	Page
	IG-XQ804506 01	6W	2700K/3000K/4000K	15°/24°/36°	Φ45mm	Φ51.5x56mm	116
	IG-XQ806008 IG-XQ806010 IG-XQ806012	8W 10W 12W	2700K/3000K/4000K	15°/24°/36°	Φ60mm	Φ66x74mm	117
	IG-XQ807510 IG-XQ807512 IG-XQ807515 IG-XQ807518	10W 12W 15W 18W*	2700K/3000K/4000K	4° 12°/15°/24°/36° 15°/24°/36° 15°/24°/36°	Φ75mm	Φ81.5x81mm	118

\*代表需定制

# Fenghua Series

风华 

Product	Model	Power	CCT	Beam angle	Cutout	Size	Page
	IG-TH306008 01	8W	2700K/3000K/4000K	15°/24°/36°	Φ60mm	Φ65x64mm	122
	IG-TH307508 01	8W	2700K/3000K/4000K	15°/24°/36°	Φ75mm	Φ82.5x82.5mm	123
	IG-TH307512 01	12W					
	IG-TH309515 01	15W	2700K/3000K/4000K	15°/24°/36°	Φ95mm	Φ101x95.5mm	125
	IG-TH309520 01	20W					
	IG-TH309525 01	25W					
	IG-TH312530 01	30W	2700K/3000K/4000K	15°/24°/36°	Φ125mm	Φ135x97mm	126
	IG-TH312535 01	35W					
	IG-GS308015 01	15W	2700K/3000K/4000K	15°/24°/36°	Φ80mm	110x110x95mm	127
	IG-GS316015 01	2x15W	2700K/3000K/4000K	15°/24°/36°	190x80mm	220x110x95mm	128
	IG-MS310015 01	15W	2700K/3000K/4000K	15°/24°/36°	吸顶式	Φ100x155mm	129
	IG-MS310015 02	15W	2700K/3000K/4000K	15°/24°/36°	吸顶式	100x100x155mm	130
	IG-XQ309512 01	12W	2700K/3000K	15°/24°/38°/60°	Φ95mm	Φ111x140mm	132
	IG-XQ309515 01	15W					
	IG-XQ309520 01	20W					
	IG-XQ309525 01	25W					
	IG-XQ309512 02	12W	2700K/3000K/4000K	15°/24°/38°/60°	Φ95mm	Φ111x133mm	133
	IG-XQ309515 02	15W					
	IG-XQ309520 02	20W					
	IG-XQ309525 02	25W					

\*代表需定制

# Funline Series









飞凌 

Product	Model	Power	CCT	Beam angle	Cutout	Size	Page
	IG-GS909508 01W	8W	2700K/3000K/4000K	15°/24°/36°	95x95mm	105x105x136mm	138
	IG-GS909508T 01W	8W	2700K/3000K/4000K	10°-60°	95x95mm	105x105x136mm	139
	IG-GS909508M 01W	8W	2700K/3000K/4000K	15°/24°/36°	95x95mm	105x105x60mm	140
	IG-GS909508 02W	8W	2700K/3000K/4000K	15°/24°/36°	90x90mm	90x90x136mm	141
	IG-GS909508T 02W	8W	2700K/3000K/4000K	10°-60°	90x90mm	90x90x136mm	142
	IG-GS909508M 02W	8W	2700K/3000K/4000K	15°/24°/36°	90x90mm	90x90x60mm	143
	IG-GS918516 01W	2x8W	2700K/3000K/4000K	15°/24°/36°	185x95mm	195x105x136mm	144
	IG-GS918516T 01W	2x8W	2700K/3000K/4000K	10°-60°	185x95mm	195x105x136mm	145
	IG-GS918516M 01W	2x8W	2700K/3000K/4000K	15°/24°/36°	185x95mm	195x105x60mm	146

\*代表需定制

# Funline Series













Product	Model	Power	CCT	Beam angle	Cutout	Size	Page
	IG-GS918516 02W	2x8W	2700K/3000K/4000K	15°/24°/36°	180x90mm	180x90x136mm	147
	IG-GS918516T 02W	2x8W	2700K/3000K/4000K	10°-60°	180x90mm	180x90x136mm	148
	IG-GS918516M 02W	2x8W	2700K/3000K/4000K	15°/24°/36°	180x90mm	180x90x60mm	149
	IG-TH909508 03W	8W	2700K/3000K/4000K	15°/24°/36°	Φ95mm	Φ110x136mm	150
	IG-TH909508T 03W	8W	2700K/3000K/4000K	10°-60°	Φ95mm	Φ110x136mm	151
	IG-TH909508M 03W	8W	2700K/3000K/4000K	15°/24°/36°	Φ95mm	Φ110x60mm	152
	IG-TH909508 04W	8W	2700K/3000K/4000K	15°/24°/36°	Φ90mm	Φ110x136mm	153
	IG-TH909508T 04W	8W	2700K/3000K/4000K	10°-60°	Φ90mm	Φ110x136mm	154
	IG-TH909508M 04W	8W	2700K/3000K/4000K	15°/24°/36°	Φ90mm	Φ110x60mm	155

\*代表需定制





# Phantom Series





Product	Model	Power	CCT	Beam angle	Cutout	Size	Page
	IG-XQ505505 01	5W	3000K/4000K	15°/24°/36°	Φ55mm	Φ62x78mm	160
	IG-XQ507508 02 IG-XQ507512 02	8W 12W	3000K/4000K	12°/24°/36°	Φ75mm	Φ82x86mm	161
	IG-XQ509512 02 IG-XQ509515 02	12W 15W	3000K/4000K	12°/24°/36°	Φ92mm	Φ102x95mm	162
	IG-XQ505505 05	5W	3000K/4000K	15°/24°/36°	Φ55mm	Φ65x76mm	164
	IG-XQ507508 06 IG-XQ507512 06	8W 12W	3000K/4000K	15°/24°/36°	Φ75mm	Φ85x80mm	165
	IG-TH709520 01	20W	3000K/4000K	12°/24°/38°	Φ95mm	Φ105x108mm	166
	IG-TH512535	35W	3000K/4000K	12°/24°/36°	Φ125mm	Φ135x141mm	168
	IG-TD505505 01	5W	3000K/4000K	60°	Φ55mm	Φ65x61mm	170
	IG-TD507507 02	7W	3000K/4000K	60°	Φ75mm	Φ85x72mm	171
	IG-TD509212 03	12W	3000K/4000K	60°	Φ95mm	Φ110x70mm	172

\*代表需定制

## Katz Series / 卡兹









Product	Model	Power	CCT	Beam angle	Cutout	Size	Page
	IG-XQ307508 01 IG-XQ307512 01	8W 12W	3000K/4000K	15°/24°/36°	Φ75mm	Φ85x93mm Φ85x103mm	176
	IG-XQ307508 02 IG-XQ307512 02	8W 12W	3000K/4000K	15°/24°/36°	Φ75mm	Φ85x84mm Φ85x94mm	177
	IG-XQ307508 03 IG-XQ307512 03	8W 12W	3000K/4000K	15°/24°/36°	Φ75mm	Φ85x93mm Φ85x103mm	178
	IG-XQ307508 04 IG-XQ307512 04	8W 12W	3000K/4000K	15°/24°	Φ75mm	Φ85x84mm Φ85x94mm	179
	IG-XQ007508 05	8W	3000K/4000K	15°/24°/36°	Φ75mm	Φ90x100mm	182

## King Series / 黑金

Product	Model	Power	CCT	Beam angle	Cutout	Size	Page
	IG-TH106006	6W	3000K/4000K	15°/30°/45°	Φ60mm	Φ66x68mm	186
	IG-TH107508 IG-TH107512	8W 12W*	3000K/4000K	15°/30°/45°	Φ75mm	Φ85x81mm	187



\*代表需定制

## King Series / 黑金

Product	Model	Power	CCT	Beam angle	Cutout	Size	Page
	IG-TH109520 IG-TH109525	20W 25W*	3000K/4000K	15°/30°/45°	Φ95mm	Φ104x106mm	188
	IG-TH112530 IG-TH112535	30W 35W	3000K/4000K	15°/24°/36°	Φ125mm	Φ140x135mm	189
	IG-GSA40030 IG-GSA27320 IG-GSA13710 IG-GSA06504 IG-GSA04502	15x2W 10x2W 5x2W 2x2W 2W	3000K/4000K	15°/30°/45°	405x37mm 273x37mm 140x37mm 68x37mm 37x37mm	413x45x49mm 280x45x49mm 147x45x49mm 75x45x49mm 45x45x49mm	192
	IG-GSB14710 02 IG-GSB14720 02 IG-GSB14730 02	10W 20W 30W	3000K/4000K	120°	140x37mm 273x37mm 4045x37mm	147x45x79mm 280x45x49mm 412.7x45x49mm	194
	IG-XQ110024 01	24W/M	2400K-6500K	30°/35°/45°/20°x40°	/	1M/0.5M/0.16M	195
	IG-XQ110024 02	24W/M	2400K-6500K	30°/35°/45°/20°x40°	/	1M/0.5M/0.16M	196
	IG-DG013812 01	12W	3000K/4000K	15°/30°/45°	2线/3线	138x35x95mm	198
	IG-DG013820 01	20W	3000K/4000K	15°/30°/45°	2线/3线	273x35x95mm	199
	IG-GS109608 01 IG-GS109612 01	8W 12W	3000K/4000K	15°/24°/36°	96x96mm	96x96x103mm	202
	IG-GS109616 02 IG-GS109624 02	2x8W 2x12W	3000K/4000K	15°/24°/36°	195x96mm	195x96x103mm	203







\*代表需定制

King Series / 黑金

Product	Model	Power	CCT	Beam angle	Cutout	Size	Page
	IG-GS009624 03 IG-GS009636 03	3x8W 3x12W	3000K/4000K	15°/24°/36°	276x96mm	276x96x103mm	204
	IG-GS012520 01	20W	3000K/4000K	15°/24°/36°	125x125mm	110x110x155mm	205
	IG-GS025540 02	2x20W	3000K/4000K	15°/24°/36°	255x125mm	240x110x155mm	206
	IG-GS037560 03	3x20W	3000K/4000K	15°/24°/36°	380x125mm	360x110x155mm	207
	IG-MS106508 01	8W	3000K/4000K	15°/30°/45°	吸顶式	Φ65x90mm	210
	IG-MS109115 01	15W	3000K/4000K	15°/30°/45°	吸顶式	Φ91x120mm	211
	IG-MS111520 01	20W	3000K/4000K	15°/30°/45°	吸顶式	Φ115x150mm	212
	IG-MS009620 01 IG-MS009625 01	20W 25W	3000K/4000K	/	吸顶式	Φ95x100mm	214



\*代表需定制

King Series / 黑金



Product	Model	Power	CCT	Beam angle	Cutout	Size	Page
	IG-MS010610 01	10W	3000K/4000K	15°/24°/38°	吸顶式	106x106x100mm	216
	IG-MS021020 01	2x10W	3000K/4000K	15°/24°/38°	吸顶式	202x106x100mm	217
	IG-TD107507 02	7W	3000K/4000K/6000K	60°	Φ75mm	Φ90x58mm	220
	IG-TD109512 03	12W	3000K/4000K/6000K	60°	Φ95mm	Φ102x68mm	221
	IG-TD112518 04	18W	3000K/4000K/6000K	60°	Φ125mm	Φ140x68mm	222
	IG-TD115025 05	25W	3000K/4000K/6000K	60°	Φ150mm	Φ180x90mm	223
	IG-TD120535 08	35W	3000K/4000K/6000K	60°	Φ205mm	Φ230x120mm	224

\*代表需定制

## PT Series / 白金

Product	Model	Power	CCT	Beam angle	Cutout	Size	Page
	IG-GS009408 01 IG-GS009412 01	8W 12W *	3000K/4000K	15°/24°/36°	95x95mm	110x110x65mm	228
	IG-GS009416 01 IG-GS009424 01	2x8W 2x12W *	3000K/4000K	15°/24°/36°	185x95mm	200x110x65mm	229
	IG-TH507508 01	8W	3000K/4000K	12°/15°/24°/36°	Φ75mm	Φ90x45mm	232

## AK75 Series



Product	Model	Power	CCT	Beam angle	Cutout	Size	Page
	IG-TH207508 01	8W	2700K/3000K/4000K	15°/24°/36°	Φ75mm	Φ90x65mm	236
	IG-TH207508 03	8W	2700K/3000K/4000K	15°/24°/36°	Φ75mm	Φ90x65mm	237
	IG-TH207508 04	8W	2700K/3000K/4000K	15°/24°/36°	Φ75mm	Φ90x65mm	238

\*代表需定制

## Mini Series / 微光







Product	Model	Power	CCT	Beam angle	Cutout	Size	Page
	IG-TH103003U 01	3W	2700K/3000K/4000K	10°/15°/24°/36°	Φ30mm	Φ36x27mm	242
	IG-TH103003U 02	3W	2700K/3000K/4000K	10°/15°/24°/36°	Φ30mm	Φ36x39mm	243
	IG-TH104003U 01	3W	2700K/3000K/4000K	10°/15°/24°/36°	Φ40mm	Φ46x44mm	244
	IG-TH104003U 02	3W	2700K/3000K/4000K	10°/15°/24°/36°	Φ40mm	Φ46x39mm	245
	IG-TH106006 01	6W	2700K/3000K/4000K	15°/24°/36°	Φ60mm	Φ68x28mm	247
	IG-TH107508 01	8W	2700K/3000K/4000K	15°/24°/36°	Φ75mm	Φ83x32.5mm	248

## Rout Series / 劳特

Product	Model	Power	CCT	Beam angle	Installation	Size	Page
	IG-MS502503 04	3W	2700K/3000K/4000K	10°/15°/24°/60°* /80°*/10°x35°*	吸顶式	Φ25x70mm Φ25x160mm *	253
	IG-DG502503 01	3W	2700K/3000K/4000K	10°/15°/24°/60°* /80°*/10°x35°*	2线/3线	Φ25x70mm Φ25x160mm *	254







\*代表需定制

Rout Series / 劳特

Product	Model	Power	CCT	Beam angle	Installation	Size	Page
	IG-TH502503 03	3W	2700K/3000K/4000K	10°/15°/24°/60°* /80°*/10°x35°*	Φ55mm	Φ25x70mm Φ25x160mm *	255
	IG-MS502503 05	3W	2700K/3000K/4000K	10°/15°/24°/60°* /80°*/10°x35°*	吊线式	Φ25x250mm	256
	IG-MS504506 04	6W	3000K/4000K	15°/24°/36°	吸顶式	Φ45x150mm Φ45x100mm *	259
	IG-DG504506 02	6W	3000K/4000K	15°/24°/36°	2线/3线/4线	Φ45x150mm Φ45x100mm *	260
	IG-TH504506 03	6W	3000K/4000K	15°/24°/36°	Φ75mm	Φ45x150mm Φ45x100mm *	261
	IG-DG504506 01	6W	3000K/4000K	15°/24°/36°	2线/3线/4线	Φ45x150mm Φ45x100mm *	262
	IG-MS504506 05	6W	3000K/4000K	15°/24°/36°	吊线式	Φ45x250mm	263
	IG-MS506008 04 IG-MS506012 04	8W 12W	3000K/4000K	12°/24°/36°	吸顶式	Φ60x165mm Φ60x125mm *	267
	IG-DG506008 02 IG-DG506012 02	8W 12W	3000K/4000K	12°/24°/36°	2线/3线/4线	Φ60x165mm Φ60x125mm *	268
	IG-TH506008 03 IG-TH506012 03	8W 12W	3000K/4000K	12°/24°/36°	Φ75mm	Φ60x165mm Φ60x125mm *	269

\*代表需定制





Rout Series / 劳特

Product	Model	Power	CCT	Beam angle	Installation	Size	Page
	IG-DG506008 01 IG-DG506012 01	8W 12W	3000K/4000K	12°/24°/36°	2线/3线/4线	Φ60x165mm Φ60x125mm *	270
	IG-MS506008 05 IG-MS506012 05	8W 12W	3000K/4000K	12°/24°/36°	吊线式	Φ60x165mm	271
	IG-MS507320 04 IG-MS507325 04	20W 25W	3000K/4000K	12°/24°/36°	吸顶式	Φ73x160mm	275
	IG-DG507320 02 IG-DG507325 02	20W 25W	3000K/4000K	12°/24°/36°	2线/3线/4线	Φ73x160mm	276
	IG-TH507320 03 IG-TH507325 03	20W 25W	3000K/4000K	12°/24°/36°	Φ75mm	Φ73x160mm	277
	IG-DG507320 01 IG-DG507325 01	20W 25W	3000K/4000K	12°/24°/36°	2线/3线/4线	Φ73x160mm	278
	IG-MS507320 05 IG-MS507325 05	20W 25W	3000K/4000K	12°/24°/36°	吊线式	Φ73x160mm	279
	IG-DG508530 02 IG-DG508535 02	30W 35W	3000K/4000K	15°/24°/36°	2线/3线/4线	Φ85x155mm	283



\*代表需定制





## Katz Series / 卡兹

Product	Model	Power	CCT	Beam angle	Installation	Size	Page
	IG-DG305208 01 IG-DG305212 02	8W 12W	3000K/4000K	12°/15°/24°/36°	2线/3线/4线	Φ52x210mm	288
	IG-MS305208 01 IG-MS305212 02	8W 12W	3000K/4000K	12°/15°/24°/36°	吸顶式	Φ52x210mm	289
	IG-DG309530 08	30W	3000K/4000K	10°/24°/36°	2线/3线/4线	Φ88x177mm	290
	IG-DG306025 01	25W	3000K/4000K	15°/24°/36°	2线/3线/4线	Φ60x165mm	292
	IG-DG306025 02	25W	3000K/4000K	15°/24°/36°	2线/3线/4线	Φ60x165mm	294
	IG-TH308530	30W	3000K/4000K	10°/24°/36°	Φ85mm	Φ88x120mm	296



## Camera Series / 照相机

Product	Model	Power	CCT	Beam angle	Installation	Size	Page
	IG-DG308512 01 IG-DG308520 02	12W 20W	3000K/4000K	15°/24°/36°	2线/3线/4线	Φ74x220mm	300
	IG-DG310330 03	30W	3000K/4000K	12°/24°/36°	2线/3线/4线	Φ94x190mm	301

## Trojan people II Series / 木马人









Product	Model	Power	CCT	Beam angle	Cutout	Size	Page
	IG-DG109830 01 IG-DG109835 02	30W 35W	3000K/4000K	12°/24°/36°	2线/3线/4线	Φ98x210x200mm	306
	IG-TH114530 IG-TH114535	30W 35W	3000K/4000K	12°/24°/36°	Φ145mm	Φ163x110mm	308

## Freeman Series / 自由人

Product	Model	Power	CCT	Beam angle	Installation	Size	Page
	IG-DG507320 06 IG-DG507325 06	20W 25W	3000K/4000K	12°/24°/36°	2线/3线/4线	Φ73x160x307mm	312
	IG-DG508530 06 IG-DG508535 06	30W 35W	3000K/4000K	15°/24°/36°	2线/3线/4线	Φ85x155x323mm	313

## Magnetically absorbent lamp

### 磁吸线型灯 NEW

Product	Model	Power	CCT	Beam angle	Installation	Size	Page
	IG-CX502503	3W	2700K/3000K/4000K	15°/24°/36°	磁吸式	Φ25x70mm Φ25x160mm *	318
	IG-CX504508	8W	2700K/3000K/4000K	15°/24°/36°	磁吸式	Φ45x150mm Φ45x100mm *	319
	IG-CX506012	12W	2700K/3000K/4000K	15°/24°/36°	磁吸式	Φ60x165mm Φ60x125mm *	320
	IG-CX507312	20W	2700K/3000K/4000K	15°/24°/36°	磁吸式	Φ73x160mm	321
	IG-M35-LB-5 IG-M35-LB-10 IG-M35-LB-15	10W 20W 30W	2700K/3000K/4000K	15°/24°/36°	磁吸式	135x34x139mm 270x34x139mm 405x34x139mm	322
	IG-CX011212-6	12W	2700K/3000K/4000K	15°/24°/36°	磁吸式	112x22x43mm	323
	IG-CX027012-10	30W	2700K/3000K/4000K	15°/24°/36°	磁吸式	270x34x69mm	324
	IG-CX308520	20W	2700K/3000K/4000K	15°/24°/36°	磁吸式	Φ73x192mm	325

\*代表需定制

## Office light

### 办公教育灯

P.328



## Office linear light

### 办公线型灯 NEW

P.340

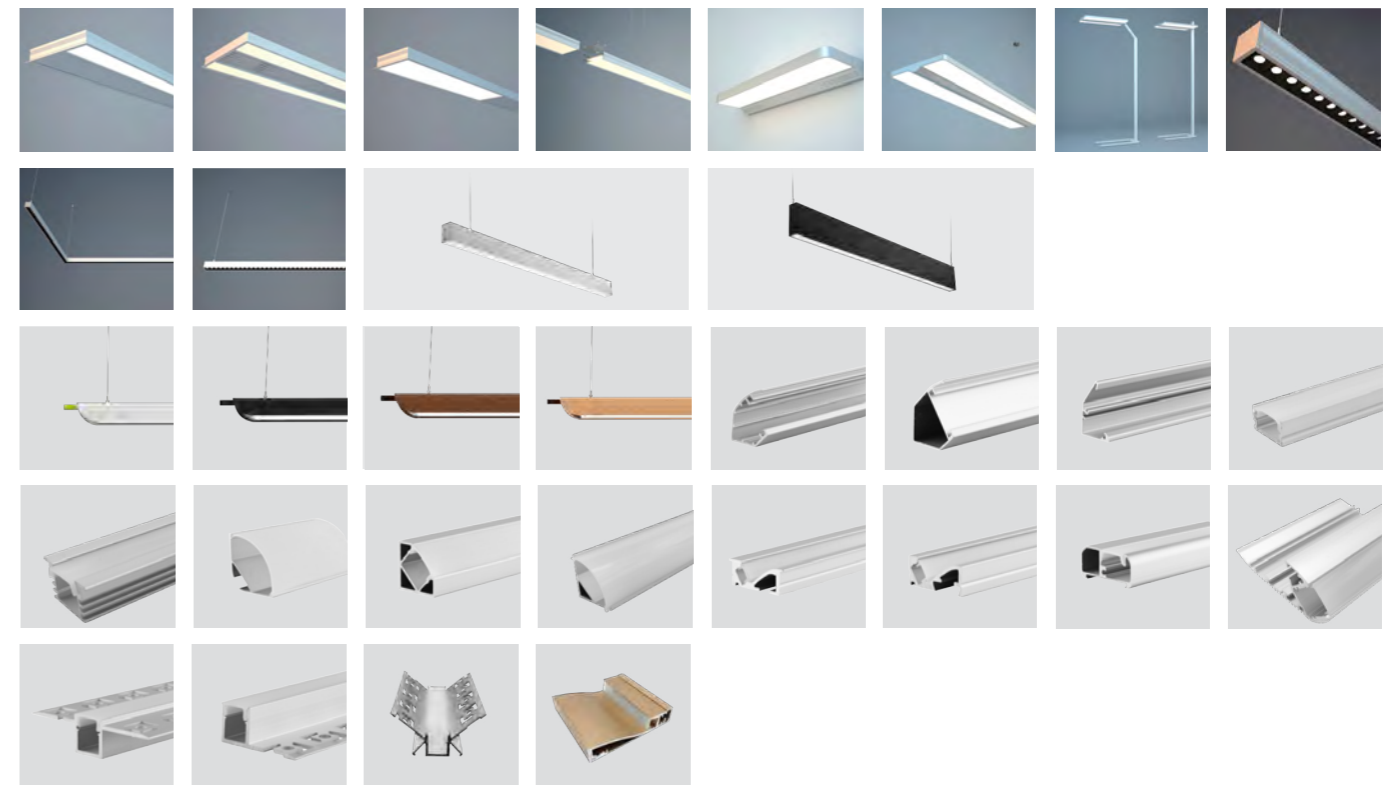

\*代表需定制

Light belt / 灯带

P.353



T5 / T8

P.359



Indoor light / 室内灯 NEW

P.363

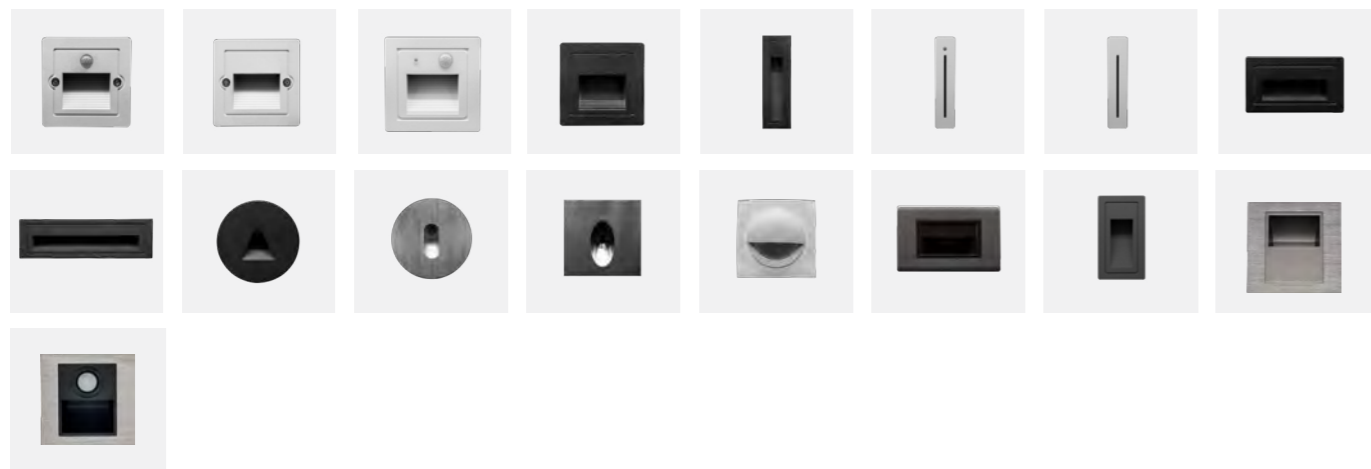

\*代表需定制

Outdoor light / 户外灯

P.369



Cabinet light / 橱柜灯 NEW

P.379



Intelligent control / 智能控制系统

P.383

\*代表需定制

# The science behind our beautiful light beams

With an emphasis on visual quality, IG lighting optics ensure smooth, even beam distributions with exceptional optical control

- No fried egg appearance
- Soft, smooth edge
- No striations
- Even colour

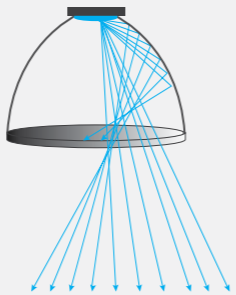
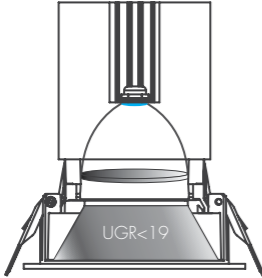
Black light reflection	Diffuse reflection
<p>Reflector electroplated with black nickel (Ni), the advantage is absorb the light, to prevent the reflector from making secondary glare, the reflector is dark when the light output, and also provide good color presentation.</p>	
	<ul style="list-style-type: none"><li>✓ Soft distribution</li><li>✓ Light nature</li><li>✓ Condense the light, light facular is full</li></ul>

# Optical flexibility

With our uncompromising approach to optics, IG lighting provides the tools for vertical illumination, general lighting or precise accentuation.

True asymmetric wallwash

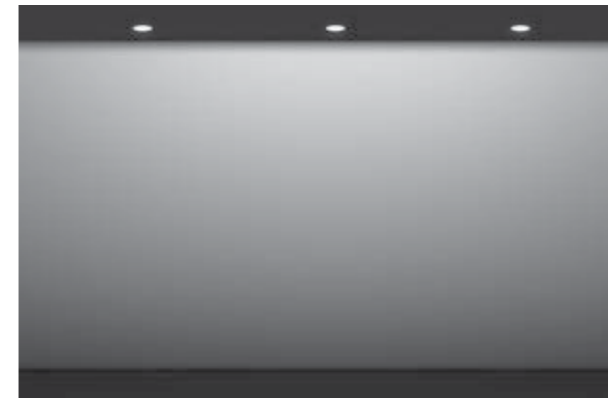

Tilt model

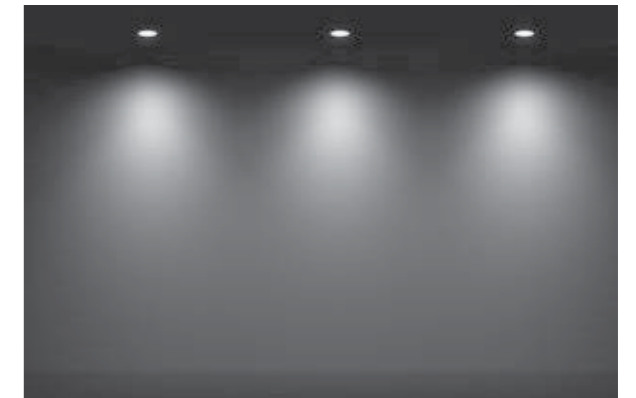

Narrow Spot 10°



Narrow 20°



Medium 40°

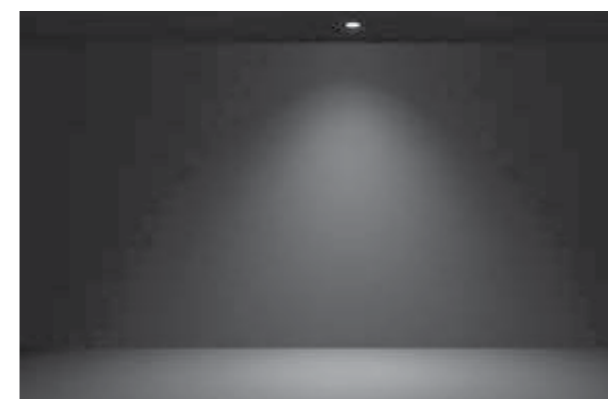

Wide 60°

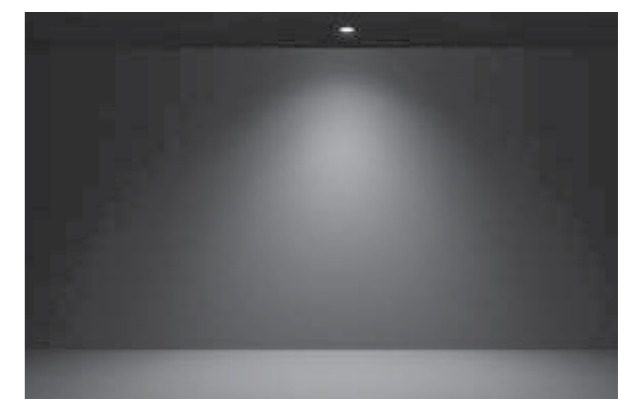

# Colour fidelity

As well as offering a choice between colour rendering indexes of 80+ and 95+, IG lighting range also includes Radiant light sources, giving a more vivid appearance to whites and colours.

**CRI**  
**80+**  
 Accurate colours

Accurate colours for general lighting applications

**CRI**  
**95+**  
 Naturalistic colours

Closer to natural light for more demanding applications such as hospitality, museums and galleries

**Radiant**  
**80+**  
 Vivid colours

Designed to make whites whiter and colours more vivid for retail and display lighting applications

**Radiant**  
**95+**  
 Naturalistic and vivid

Vivid colours combined with natural accuracy for high-end applications such as fashion retail and cosmetics

Comparing CRI 80+ vs CRI 95+, 3000K

	Ra	R1	R2	R3	R4	R5	R6	R7	R8	R9	R10	R11	R12	R13	R14	R15
CRI 80+	84	82	90	97	83	82	88	86	63	15	77	83	68	84	98	75
CRI 95+	97	96	97	99	96	96	95	96	97	97	96	95	86	96	98	97

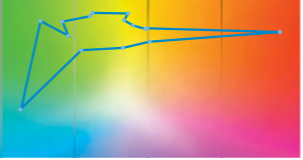

Standard gamut area

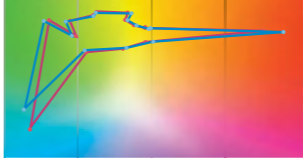

Radiant gamut area

### What is Radiant ?

Most LED light sources are designed to use the same range of colours as incandescent light sources – known as the black body curve. Our Radiant sources use the flexibility of LED to fine-tune the colour of the light so that whites appear cleaner and colours appear more vivid – especially reds, blues and pinks. The result? Objects appear brighter, bolder and more radiant.



## AKARI 阿卡丽·为舒适而生

上古时代，在亚平宁半岛上有个神的家族，该家族相信万物必须和谐共存的真理，历任族长都叫阿卡丽女神，女神带领着族人毕生致力于规则与混乱、光明与黑暗的平衡，以求万物的和谐共生。万物无需排他，明暗可以平衡，IG 照明工程师以此获得灵感，将直接照明灯具在设计中加入间接照明的手法，并通过光学设计进行眩光值最大化降低，研发出具有独创四重黑光、藏光、凝光、滤光四重防眩设计， $UGR < 16$ ，多种安装方式，过百种功能配置的酒店照明灯具，并用阿卡丽女神进行命名——AKARI 阿卡丽系列，专为解决直接照明与间接照明之间的平衡，灯具应用与空间融入感的平衡，把舒适值最大化，营造舒适的酒店照明。



# Soft

极致柔和

灯光的另一境界——在保持功能性不下降的情况下，光效达到更为柔和的体验

让舒适光照体验进行到底

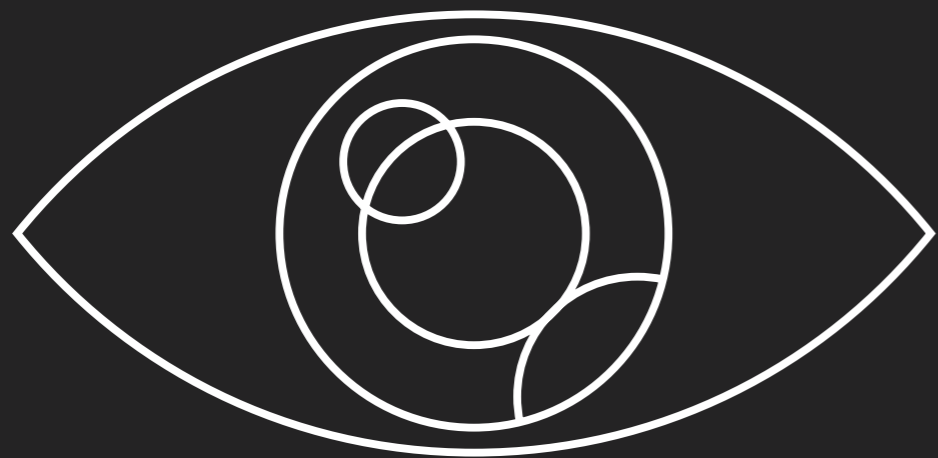

*UGR < 16*

统一眩光值 UGR<16

阿卡丽系列涵盖天花灯、洗墙灯、格栅灯，每一盏灯均是精品之作，细腻的质感融合四重防眩奥义，如阿卡丽女神般优雅、经典、聪慧，肩负着维护光明与黑暗的平衡。





THE NEW  
**AKARI** 0655



不止于小，恰到好处

能握在手心的柔光洗墙灯，小型高防眩柔光洗墙灯，Cut out: 55mm

适用于：酒店·别墅·会所·豪宅·民宿

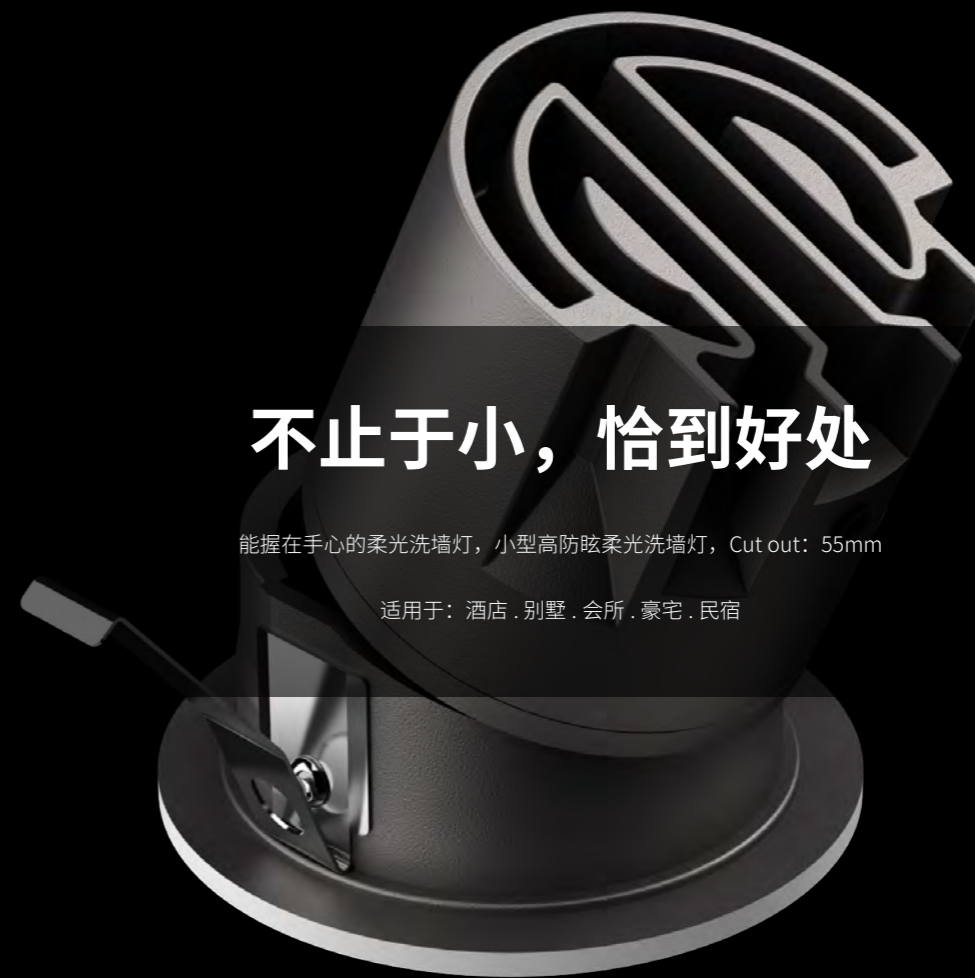

# 灯体高度 70mm

*Lamp height*

UGR<16, 灯体高度 70mm, 适配更多安装空间

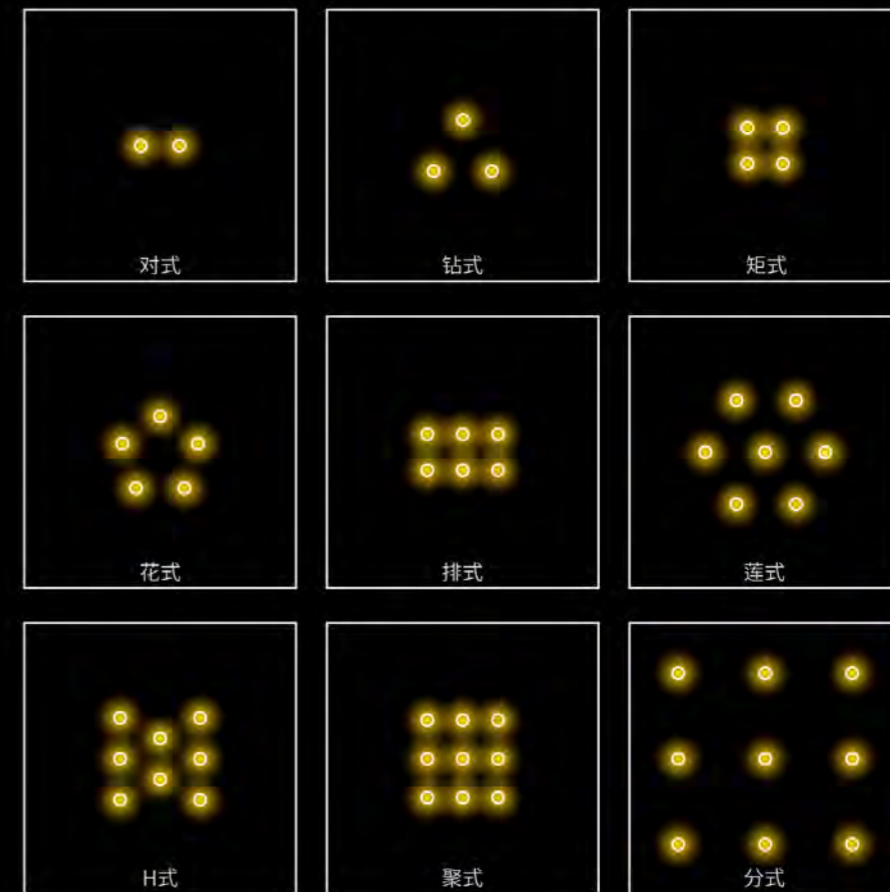
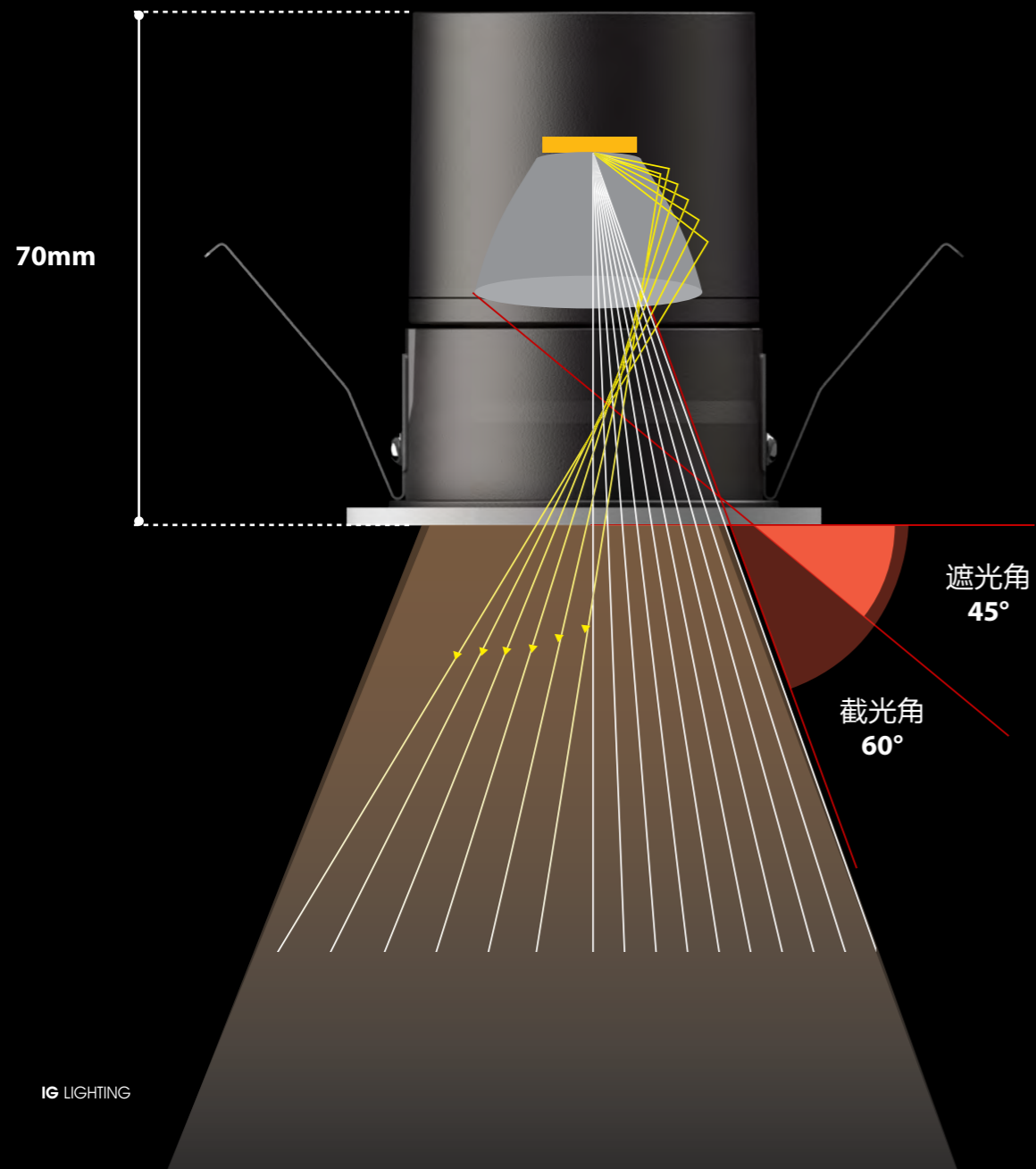

小型化灯具，为去主灯空间实现更好的点阵应用，

应用更灵活，空间更灵动，照明更灵气。

# 小孔径，宽广角

*Small aperture, wide width angle*

UGR<16, 灯体高度 70mm, 适配更多安装空间

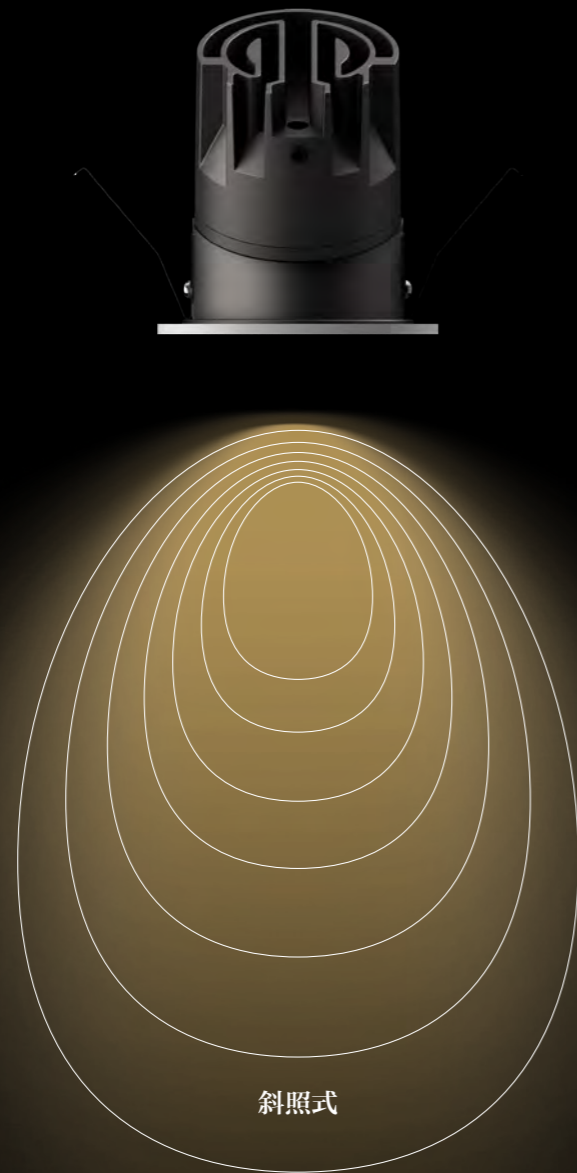

# 点亮你的美

*Light up your beauty*

精准光，定位光



## 窄边面环

透镜款面环厚度仅 1.6mm.

且采用窄边设计,

透镜和反光杯, 两个光学组件可选;

满足不同要求。



## 透镜款 vs 反光杯款

采用 LED 光学透镜,

最小光束角可达到 10° ,

最大光束角可达到 60° ,

反射器二次反射造成眩光, 配光更准确,

真正做到见光不见灯, 灯光品质再度升级。

透镜的中心光强比反光杯高 2 倍,

透镜光源深藏, 防眩效果好,

角度精准、且光斑圆润, 无杂散光;

照度高, 光斑透澈。



反光杯



透镜

## 旗舰版驱动

此款驱动采用双极无频闪控制方案, 功率因素最高时可 > 0.98, 大大提升电网利用率。采用两极线路, 输出纹波低至 3% 以下, 降低输出纹波对光源的影响, 提高光源输出的稳定性和长寿性。可靠的 EMC/EMI 控制, 有效保证外界电网对灯具的干扰, 同时也使得电器本身不对外界电网或电器进行辐射干扰。电路采用两极有源控制, 对输出短路和输出开路进行保护, 使得灯具端出现各种异常均能有效保证电源的可靠性, 确保电源整机的安全性能。



24° 反光杯

24° 透镜

36° 反光杯

36° 透镜



- UGR <16
- No flickering
- 2700K
- 3000K
- 4000K
- CCT Dimmable
- WH+GR
- BL\*
- 25°
- IP20
- IP44\*

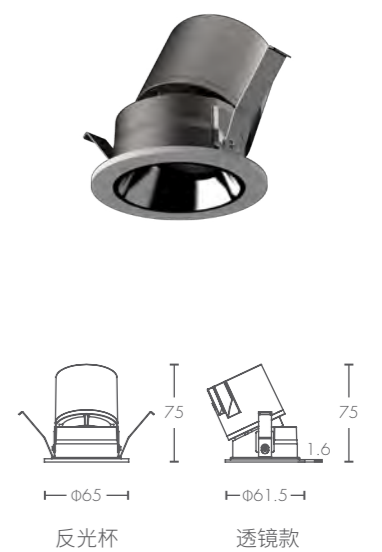

**PRODUCT DATA** 产品参数

Model 型号	Power/CCT 功率 / 色温	Light Output 光通量	Light Efficiency 光效率	CRI 显指	Beam angle 光束角	Cutout 开孔尺寸	QTY 装箱数
IG-XQ605506 01-反光杯	6W/3000K	≥300 lm	≥50 lm/W	95	15°/24°/36°	φ55mm	45PCS
IG-XQ605507 01-透镜款	7W/3000K	≥396 lm	≥60 lm/W	90	10°/15°/24°/36°/50°	φ55mm	24PCS

- 可定制调光方式: 0/1-10v, Triac, DALI Dimming
- 配件可选项: 黑镍, 玫瑰金, 哑白, 白铬, 防眩蜂窝网片

**PHOTOMETRIC** 配光参数

反光杯:

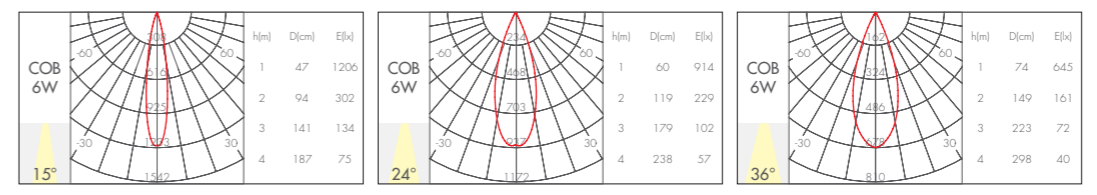

透镜款:

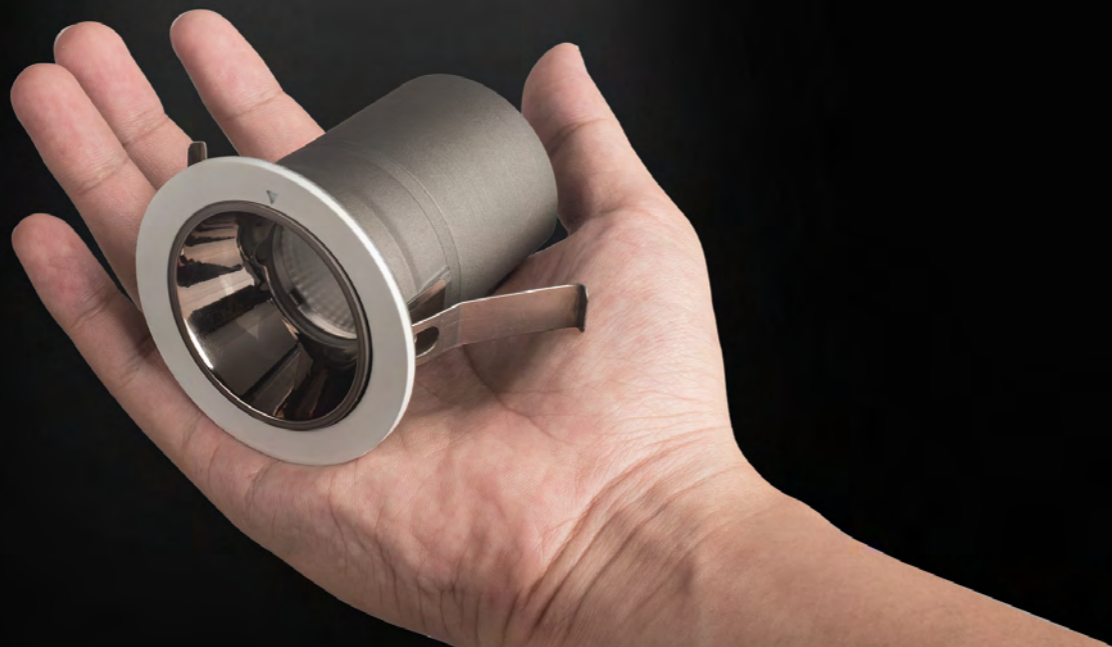
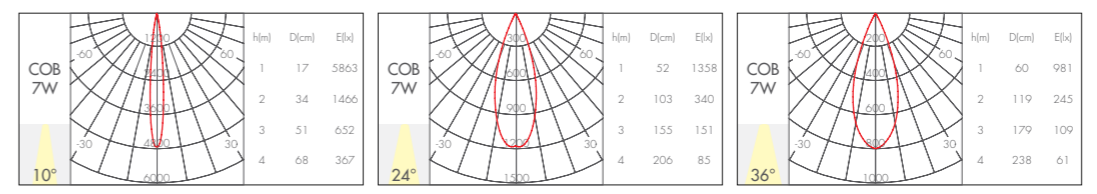

UGR <16 No flickering 2700K 3000K 4000K CCT Dimmable WH+GR BL\* 25° IP20 IP44\*

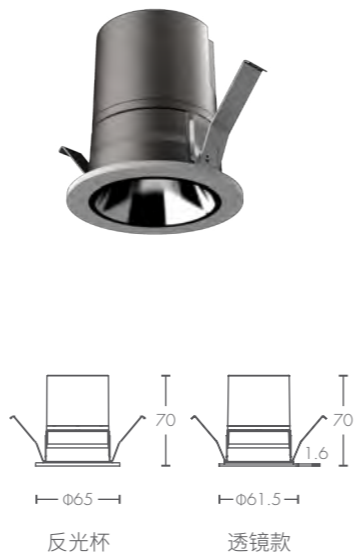

PRODUCT DATA 产品参数

Model 型号	Power/CCT 功率 / 色温	Light Output 光通量	Light Efficiency 光效率	CRI 显指	Beam angle 光束角	Cutout 开孔尺寸	QTY 装箱数
IG-XQ605506 02- 反光杯	6W/3000K	≥300 lm	≥50 lm/W	95	15°/24°/36°	φ55mm	45PCS
IG-XQ605507 02- 透镜款	7W/3000K	≥396 lm	≥60 lm/W	90	10°/15°/24°/36°/50°*	φ55mm	24PCS

可定制调光方式: 0/1-10v Triac DALI Dimming

配件可选项: 黑镍 玫瑰金 哑白 白铬 防眩蜂窝网片

PHOTOMETRIC 配光参数

反光杯:

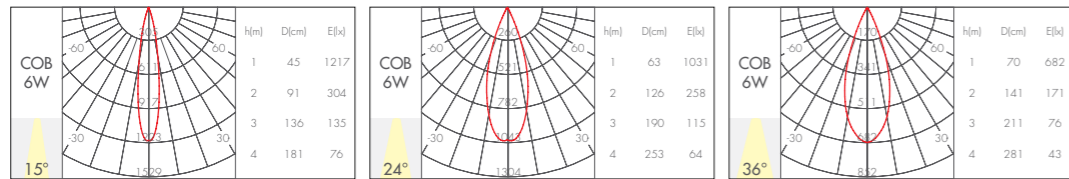

透镜款:

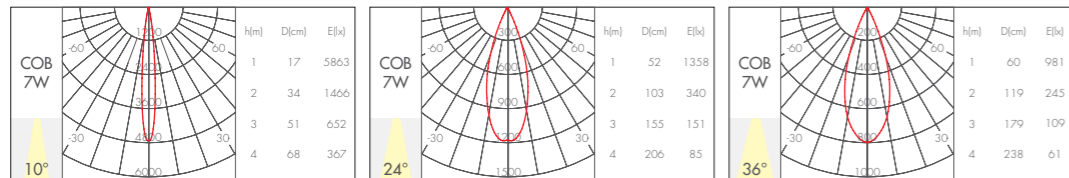

UGR <16 No flickering 2700K 3000K 4000K CCT Dimmable WH+GR BL\* 25° IP20 IP44\*



PRODUCT DATA 产品参数

Model 型号	Power/CCT 功率 / 色温	Light Output 光通量	Light Efficiency 光效率	CRI 显指	Beam angle 光束角	Cutout 开孔尺寸	QTY 装箱数
IG-XQ605506 03- 反光杯	6W/3000K	≥180 lm	≥30 lm/W	95	15°/24°/36°	φ55mm	45PCS
IG-XQ605507 03- 透镜款	7W/3000K	≥307 lm	≥45 lm/W	90	10°/15°/24°/36°/50°*	φ55mm	24PCS

可定制调光方式: 0/1-10v Triac DALI Dimming

配件可选项: 防眩蜂窝网片

PHOTOMETRIC 配光参数

反光杯:

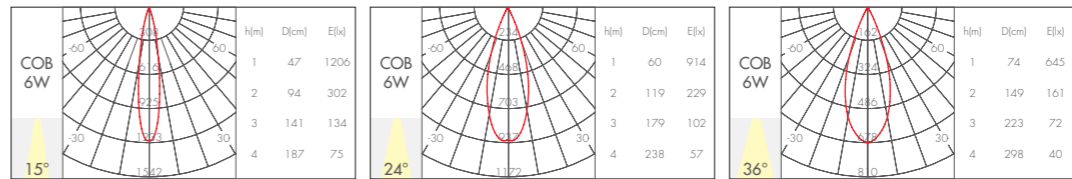

透镜款:

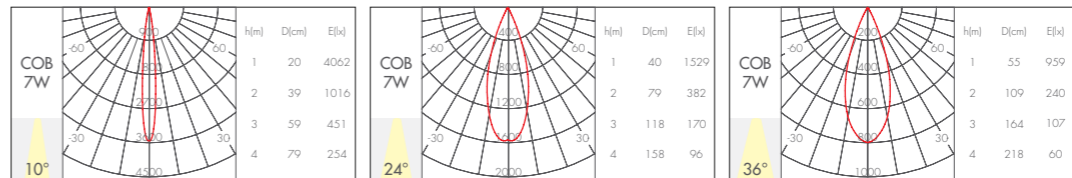

UGR <16 No flickering 2700K 3000K 4000K CCT Dimmable WH+GR BL\* 25° IP20 IP44\*

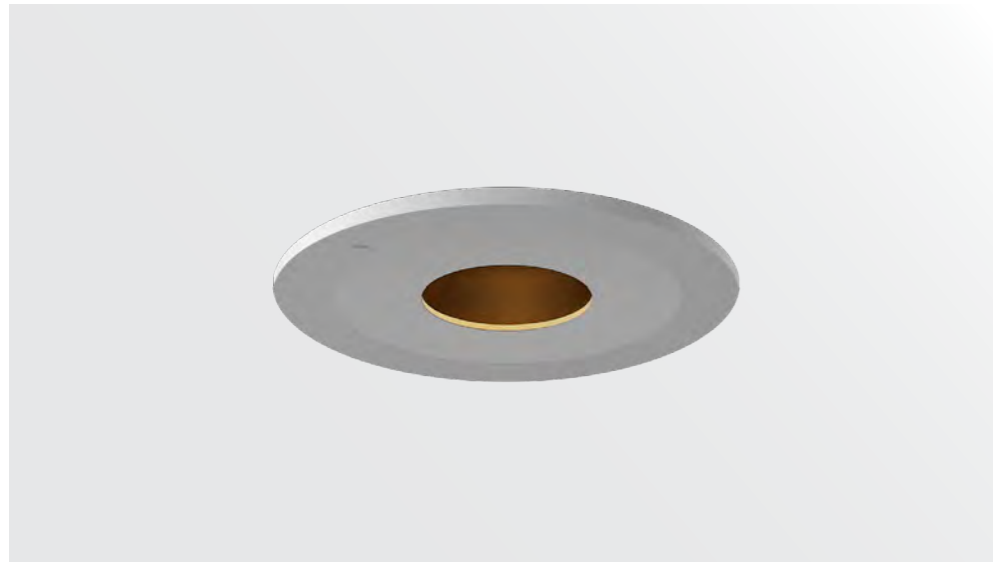

PRODUCT DATA 产品参数

Model 型号	Power/CCT 功率 / 色温	Light Output 光通量	Light Efficiency 光效率	CRI 显指	Beam angle 光束角	Cutout 开孔尺寸	QTY 装箱数
IG-XQ605506 04- 反光杯	6W/3000K	≥210 lm	≥35 lm/W	95	15°/24°/36°	Φ55mm	45PCS
IG-XQ605507 04- 透镜款	7W/3000K	≥307 lm	≥45 lm/W	90	10°/15°/24°/36°/50°	Φ55mm	24PCS

可定制调光方式: 0/1-10v Triac DALI Dimming

配件可选项: 防眩蜂窝网片

PHOTOMETRIC 配光参数

反光杯:

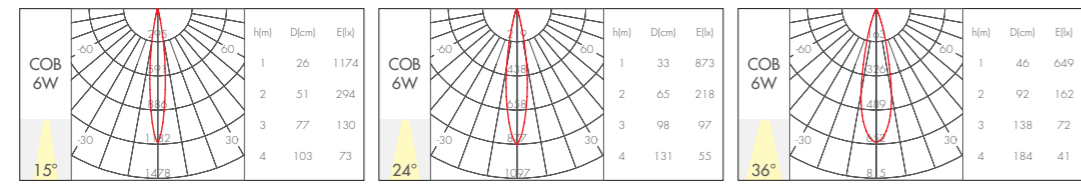

透镜款:

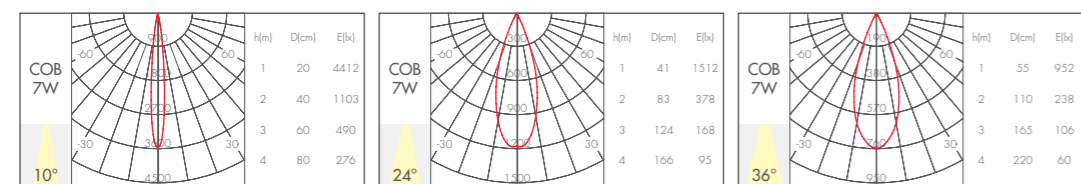

UGR <16 No flickering 2700K 3000K 4000K CCT Dimmable WH+GR BL\* 25° IP20 IP44\*

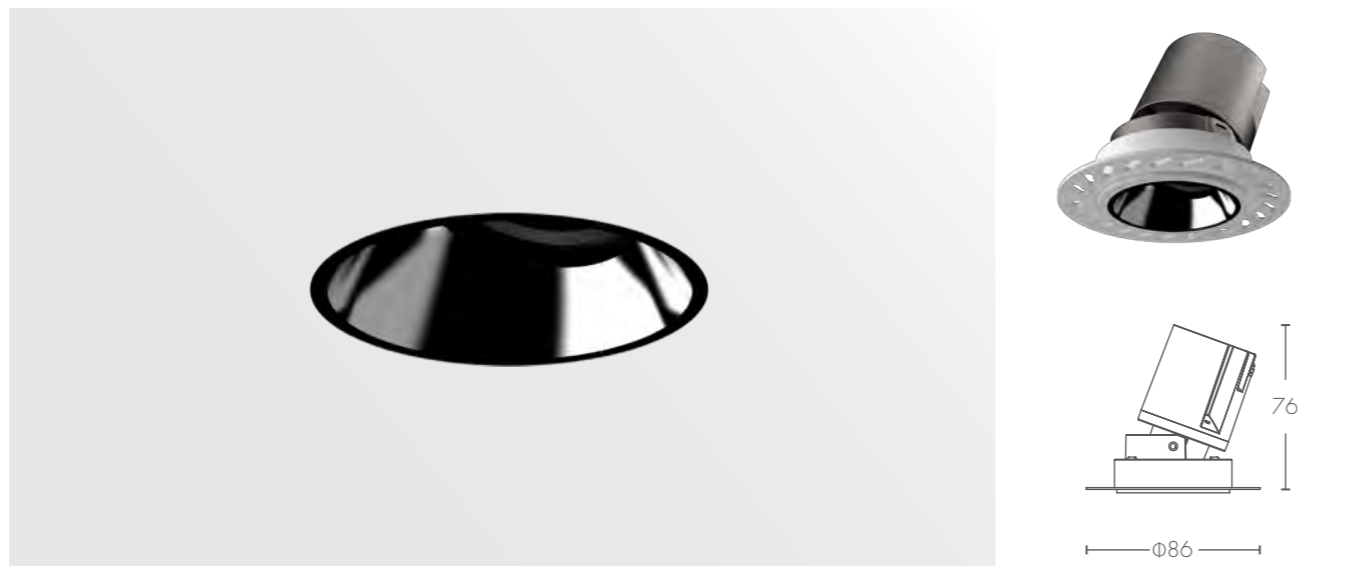

**PRODUCT DATA 产品参数**

Model 型号	Power/CCT 功率 / 色温	Light Output 光通量	Light Efficiency 光效率	CRI 显指	Beam angle 光束角	Cutout 开孔尺寸	QTY 装箱数
IG-XQ606006 01-反光杯	6W/3000K	≥300 lm	≥50 lm/W	95	15°/24°/36°	Ø60mm	45PCS
IG-XQ606007 01-透镜款	7W/3000K	≥396 lm	≥60 lm/W	90	10°/15°/24°/36°/50°	Ø60mm	24PCS

可定制  
调光方式: 0/1-10v Triac DALI Dimming

配件  
可选项: 黑镍 玫瑰金 哑白 白铬 防眩蜂窝网片

**PHOTOMETRIC 配光参数**

反光杯:

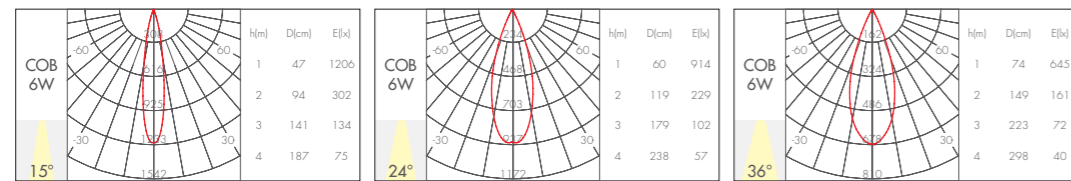

透镜款:

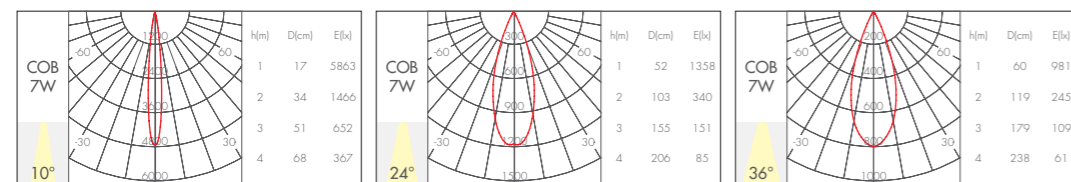

UGR <16 No flickering 2700K 3000K 4000K CCT Dimmable WH+GR BL\* 25° IP20 IP44\* 45PCS



**PRODUCT DATA 产品参数**

Model 型号	Power/CCT 功率 / 色温	Light Output 光通量	Light Efficiency 光效率	CRI 显指	Beam angle 光束角	Cutout 开孔尺寸	QTY 装箱数
IG-XQ606006 02-反光杯	6W/3000K	≥300 lm	≥50 lm/W	95	15°/24°/36°	Ø60mm	45PCS
IG-XQ606007 02-透镜款	7W/3000K	≥396 lm	≥60 lm/W	90	10°/15°/24°/36°/50°	Ø60mm	24PCS

可定制  
调光方式: 0/1-10v Triac DALI Dimming

配件  
可选项: 黑镍 玫瑰金 哑白 白铬 防眩蜂窝网片

**PHOTOMETRIC 配光参数**

反光杯:

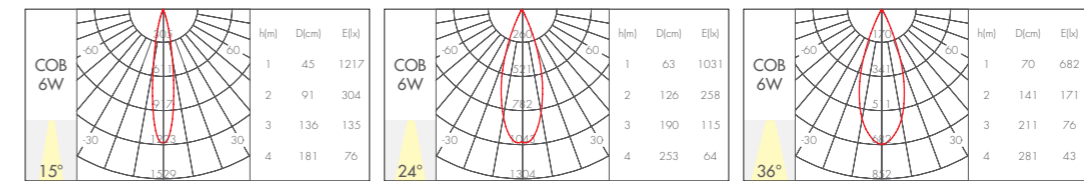

透镜款:

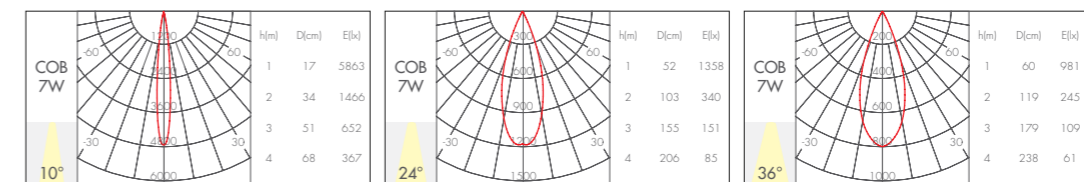



UGR <16 No flickering 2700K 3000K 4000K CCT Dimmable WH+GR BL\* 25° IP20 IP44\*

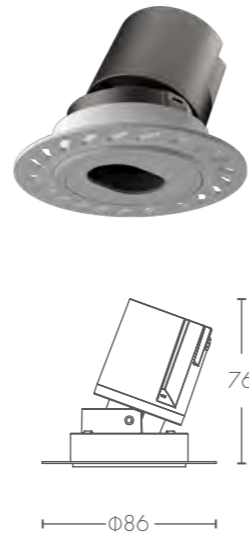

PRODUCT DATA 产品参数

Model 型号	Power/CCT 功率 / 色温	Light Output 光通量	Light Efficiency 光效率	CRI 显指	Beam angle 光束角	Cutout 开孔尺寸	QTY 装箱数
IG-XQ606006 03- 反光杯	6W/3000K	≥180 lm	≥30 lm/W	95	15°/24°/36°	Φ60mm	45PCS
IG-XQ606007 03- 透镜款	7W/3000K	≥307 lm	≥45 lm/W	90	10°/15°/24°/36°/50°	Φ60mm	24PCS

可定制  
调光方式: 0/1-10v Triac DALI Dimming

配件  
可选项: 防眩蜂窝网片

PHOTOMETRIC 配光参数

反光杯:

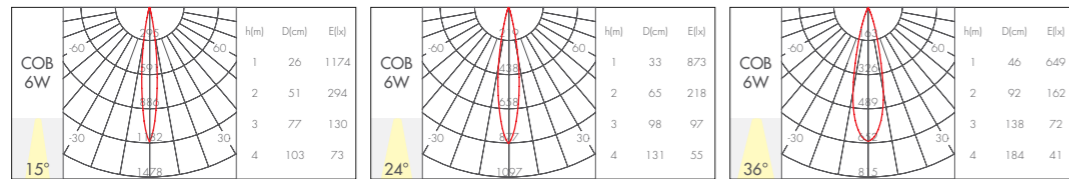

透镜款:

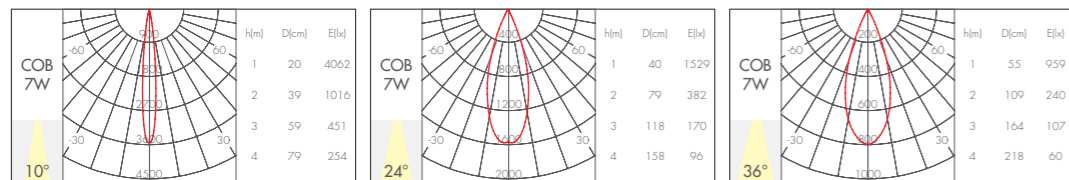

UGR <16 No flickering 2700K 3000K 4000K CCT Dimmable WH+GR BL\* 25° IP20 IP44\*

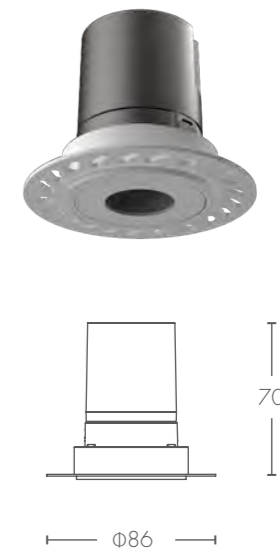

PRODUCT DATA 产品参数

Model 型号	Power/CCT 功率 / 色温	Light Output 光通量	Light Efficiency 光效率	CRI 显指	Beam angle 光束角	Cutout 开孔尺寸	QTY 装箱数
IG-XQ606006 04- 反光杯	6W/3000K	≥210 lm	≥35 lm/W	95	15°/24°/36°	Φ60mm	45PCS
IG-XQ606007 04- 透镜款	7W/3000K	≥307 lm	≥45 lm/W	90	10°/15°/24°/36°/50°	Φ60mm	24PCS

配件  
可选项: 防眩蜂窝网片

PHOTOMETRIC 配光参数

反光杯:

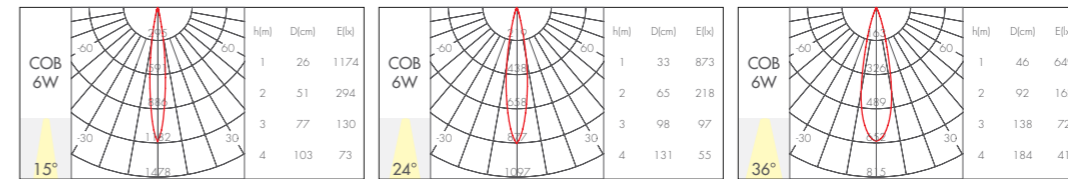

透镜款:

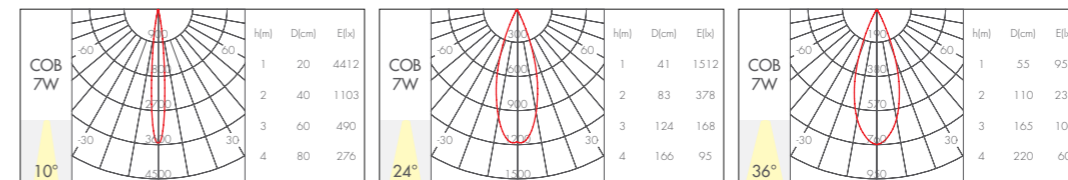



THE NEW  
**AKARI** 1275

## 四重防眩奥义

阿卡丽四重防眩设计，防眩度达到 UGR<16 的舒适灯光标准，  
致力将舒适进行到底！为酒店、会所、别墅酝酿五星级灯光效果！

# 1 黑光

Black Light

黑金技术能保证光源的反射效率，也防止反射器制造二次眩光，光输出时反射器是暗的，有效杜绝天花灯眩眼的视觉污染



# 2 藏光

Hide Light

增加灯具光源与发光口的距离深度，将光源的发射范围缩小，保证人们在一定的视觉范围内无法直接看到光源，减少直接眩光



# 3 凝光

Focus Light

在结构上，阿卡丽把出光口科学收窄配合柔光镜片，更加精准把握发光角度，减少多余光束，凝聚光线，光斑更加均匀饱满

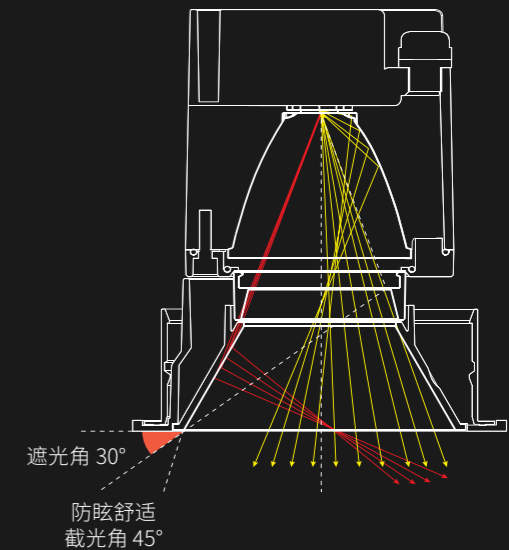

# 4 滤光

Filter Light

配搭蜂窝网格将光源分割成小光束，过滤杂光，使光线变得柔和不刺眼，更可选择搭配光学配件（彩光滤镜、条纹滤镜、布纹滤镜、磨砂滤镜、蜂窝网格等）营造氛围，非常适合于酒店客房使用

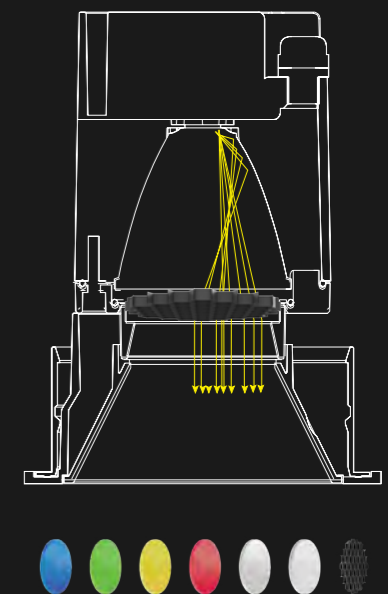

## 超模组

### *Super LED Engine*

阿卡丽超模组，不仅拥有极致的防眩性能，高显色 CRI>95，旋涡散热结构，模组防护等级达到 IP44，并且能匹配阿卡丽系列组件，组合成上百种规格的阿卡丽射灯，满足各种高要求的用光环境

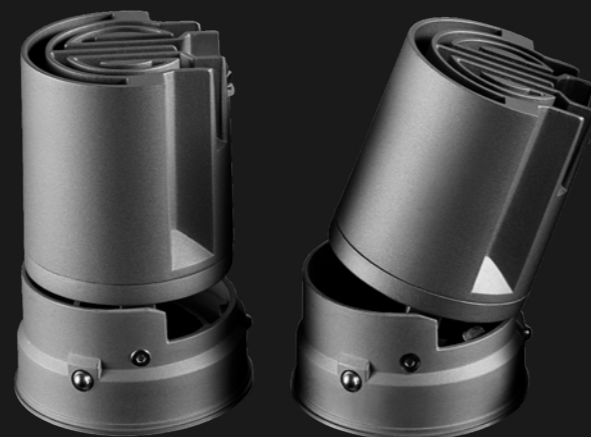

## 旋涡散热

### *Vortex Heat Sink*

高密度铝材一体压铸成型，独特的引导散热造型，加速空气对流进行充分的被动散热，保障灯具延长使用寿命



## 预埋结构

### *Embedded Structure*

采用分体式预置，可选择预埋式安装或整体安装方式，安装维护更方便快捷，拒绝损坏灯具、天花



## CRI>95

采用高品质进口 LED 芯片，逼真的色彩还原、超高的显色性亦是阿卡丽系列产品能在任何场景都能完美演绎的信心保证

## 窄边面环

透镜款面环边缘变得更加窄和薄，  
预埋件颜色改为灰色，安装方式改为弹片。



## 透镜款 vs 反光杯款

采用 LED 光学透镜，  
最小光束角可达到 10°，  
最大光束角可达到 60°，  
反射器二次反射造成眩光，配光更准确，  
真正做到见光不见灯，灯光品质再度升级。  
透镜的中心光强比反光杯高 2 倍，  
透镜光源深藏，防眩效果好，  
角度精准、且光斑圆润，无杂散光；  
照度高，光斑透澈。



反光杯



透镜

## 旗舰版驱动

此款驱动采用双极无频闪控制方案，功率因素最高时可 > 0.98，  
大大提升电网利用率。采用两极线路，输出纹波低至 3% 以下，降  
低输出纹波对光源的影响，提高光源输出的稳定性和长寿性。可靠  
的 EMC/EMI 控制，有效保证外界电网对灯具的干扰，同时也使  
得电器本身不对外界电网或电器进行辐射干扰。电路采用两极有源  
控制，对输出短路和输出开路进行保护，使得灯具端出现各种异常  
均能有效保证电源的可靠性，确保电源整机的安全性能。



24° 反光杯

24° 透镜

36° 反光杯

36° 透镜





- UGR <16
- No flickering
- 2700K
- 3000K
- 4000K
- CCT Dimmable
- WH+GR
- BL\*
- 25°
- 360°
- IP20
- IP44\*
- 30PCS

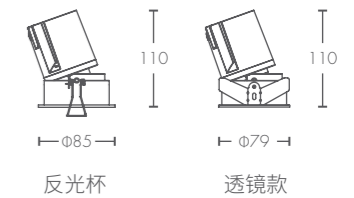

### PRODUCT DATA 产品参数

Model 型号	Power/CCT 功率 / 色温	Light Output 光通量	Light Efficiency 光效率	CRI 显指	Beam angle 光束角	Cutout 开孔尺寸
IG-XQ607508 01-反光杯	8W/3000K	≥360 lm	≥45 lm/W	95	15°/24°/36°	φ75mm
IG-XQ607508 01-透镜款	8W/3000K	≥480 lm	≥60 lm/W	90	10°/12°/15°/24°/36°/60°*	φ75mm
IG-XQ607512 01-反光杯	12W/3000K	≥450 lm	≥45 lm/W	95	15°/24°/36°	φ75mm
IG-XQ607512 01-透镜款	12W/3000K	≥651 lm	≥56 lm/W	90	10°/12°/15°/24°/36°/60°*	φ75mm

可定制  
调光方式:



配件  
可选项:



### PHOTOMETRIC 配光参数

反光杯:

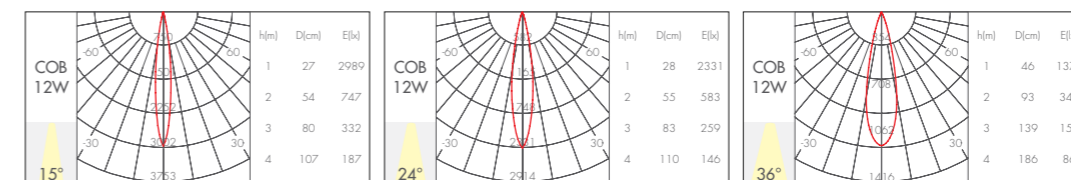

透镜款:

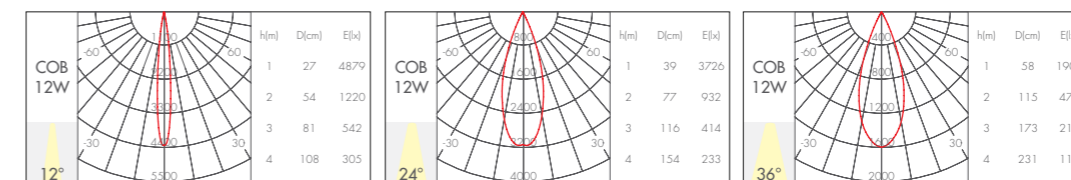



**PRODUCT DATA** 产品参数

Model 型号	Power/CCT 功率 / 色温	Light Output 光通量	Light Efficiency 光效率	CRI 显指	Beam angle 光束角	Cutout 开孔尺寸
IG-XQ607508 02- 反光杯	8W/3000K	≥360 lm	≥45 lm/W	95	15°/24°/36°	Φ75mm
IG-XQ607508 02- 透镜款	8W/3000K	≥480 lm	≥60 lm/W	90	10°/12°/15°/24°/36°/60°*	Φ75mm
IG-XQ607512 02- 反光杯	12W/3000K	≥540 lm	≥45 lm/W	95	15°/24°/36°	Φ75mm
IG-XQ607512 02- 透镜款	12W/3000K	≥651 lm	≥56 lm/W	90	10°/12°/15°/24°/36°/60°*	Φ75mm



**PHOTOMETRIC** 配光参数

反光杯:

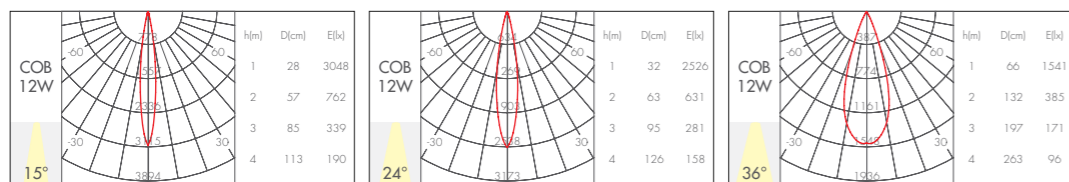

透镜款:

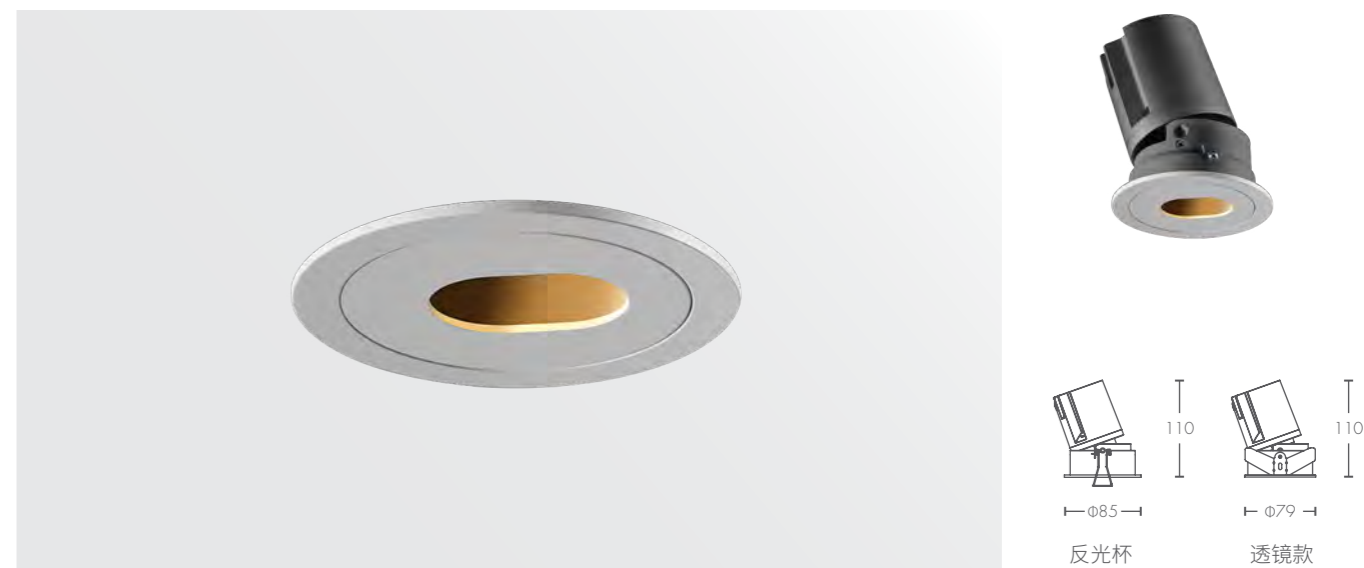
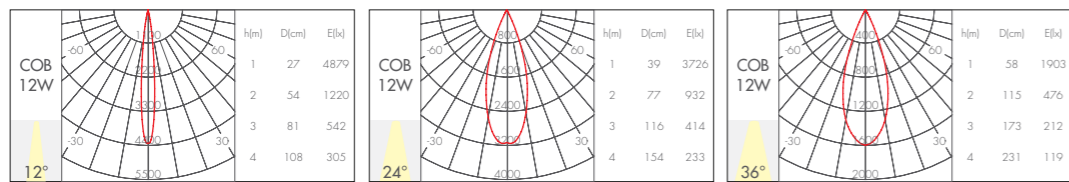

**PRODUCT DATA** 产品参数

Model 型号	Power/CCT 功率 / 色温	Light Output 光通量	Light Efficiency 光效率	CRI 显指	Beam angle 光束角	Cutout 开孔尺寸
IG-XQ607508 03- 反光杯	8W/3000K	≥280 lm	≥35 lm/W	95	15°/24°/36°	Φ75mm
IG-XQ607508 03- 透镜款	8W/3000K	≥376 lm	≥47 lm/W	90	10°/12°/15°/24°/36°/60°*	Φ75mm
IG-XQ607512 03- 反光杯	12W/3000K	≥420 lm	≥35 lm/W	95	15°/24°/36°	Φ75mm
IG-XQ607512 03- 透镜款	12W/3000K	≥487 lm	≥42 lm/W	90	10°/12°/15°/24°/36°/60°*	Φ75mm



**PHOTOMETRIC** 配光参数

反光杯:

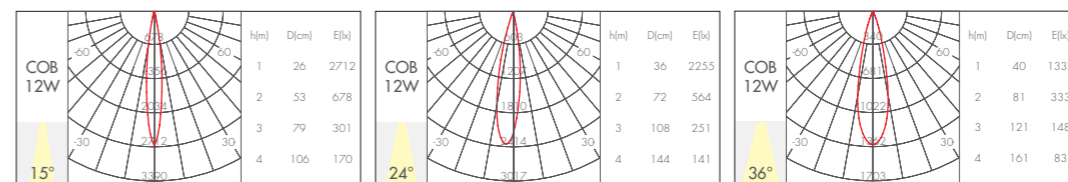

透镜款:

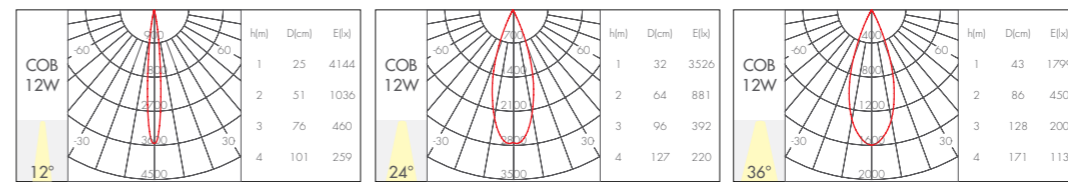



UGR <16    No flickering    2700K    3000K    4000K    CCT Dimmable    WH+GR    BL\*    25°    360°    IP20    IP44\*    30PCS

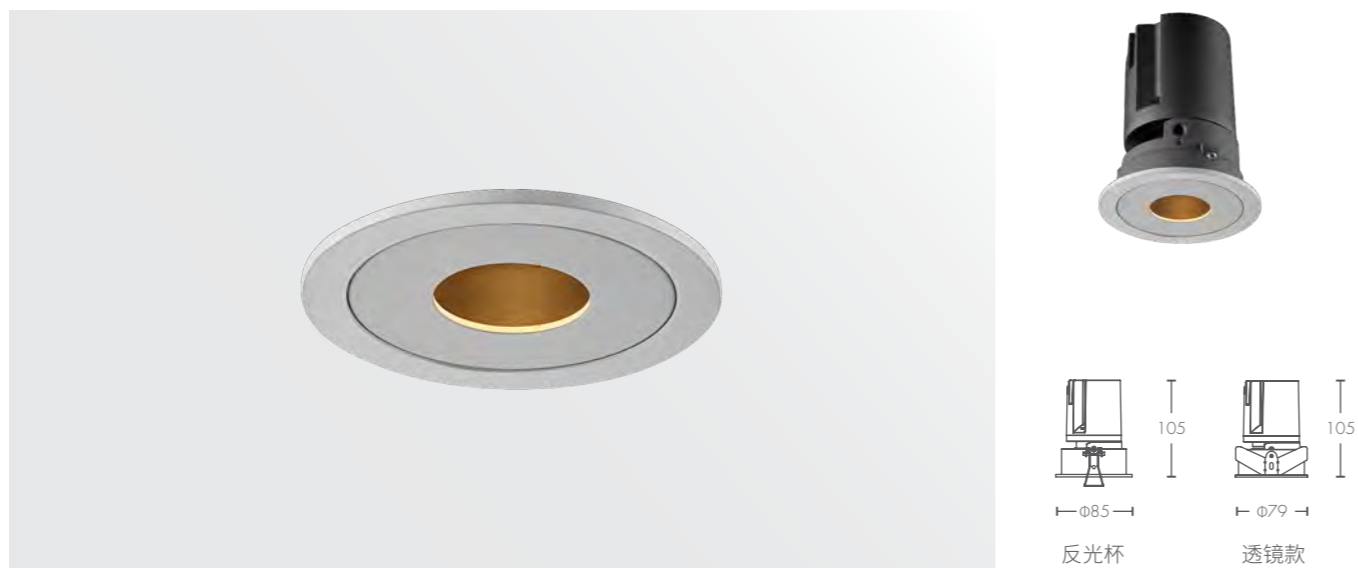

**PRODUCT DATA 产品参数**

Model 型号	Power/CCT 功率 / 色温	Light Output 光通量	Light Efficiency 光效率	CRI 显指	Beam angle 光束角	Cutout 开孔尺寸
IG-XQ607508 04- 反光杯	8W/3000K	≥240 lm	≥30 lm/W	95	15°/24°/36°	Φ75mm
IG-XQ607508 04- 透镜款	8W/3000K	≥360 lm	≥45 lm/W	90	10°/12°/15°/24°/36°/60°*	Φ75mm
IG-XQ607512 04- 反光杯	12W/3000K	≥360 lm	≥30 lm/W	95	15°/24°/36°	Φ75mm
IG-XQ607512 04- 透镜款	12W/3000K	≥458 lm	≥40 lm/W	90	10°/12°/15°/24°/36°/60°*	Φ75mm

可定制调光方式: 0/1-10v    Triac    DALI Dimming

配件可选项: 防眩蜂窝网片

**PHOTOMETRIC 配光参数**

反光杯:

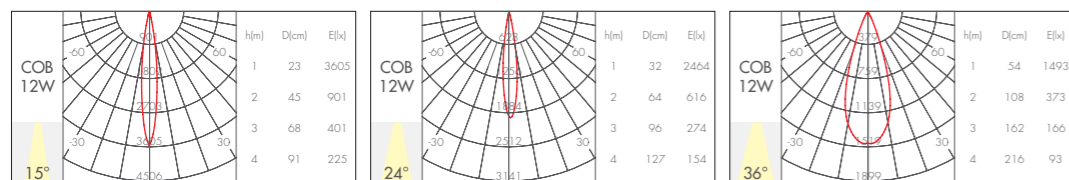

透镜款:

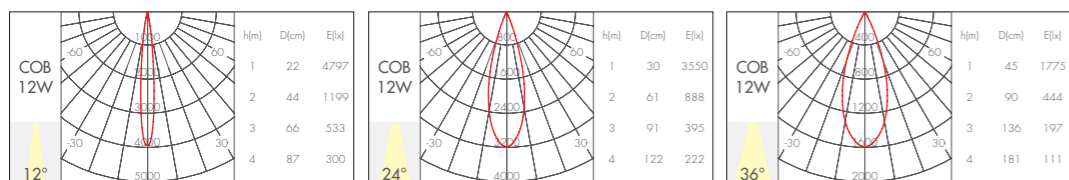



**PRODUCT DATA** 产品参数

Model 型号	Power/CCT 功率 / 色温	Light Output 光通量	Light Efficiency 光效率	CRI 显指	Beam angle 光束角	Cutout 开孔尺寸
IG-XQ608008 01- 反光杯	8W/3000K	≥360 lm	≥45 lm/W	95	15°/24°/36°	Φ80mm
IG-XQ608008 01- 透镜款	8W/3000K	≥480 lm	≥60 lm/W	90	10°/12°/15°/24°/36°/60°*	Φ80mm
IG-XQ608012 01- 反光杯	12W/3000K	≥450 lm	≥45 lm/W	95	15°/24°/36°	Φ80mm
IG-XQ608012 01- 透镜款	12W/3000K	≥651 lm	≥56 lm/W	90	10°/12°/15°/24°/36°/60°*	Φ80mm



**PHOTOMETRIC** 配光参数

反光杯:

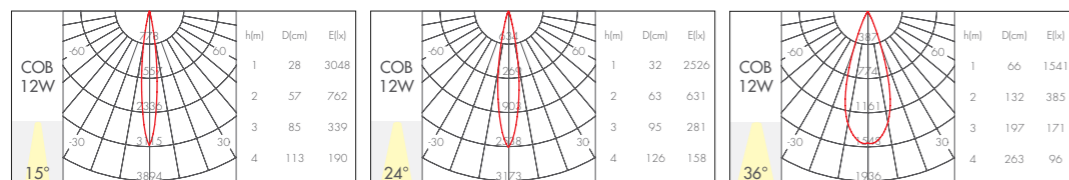

透镜款:

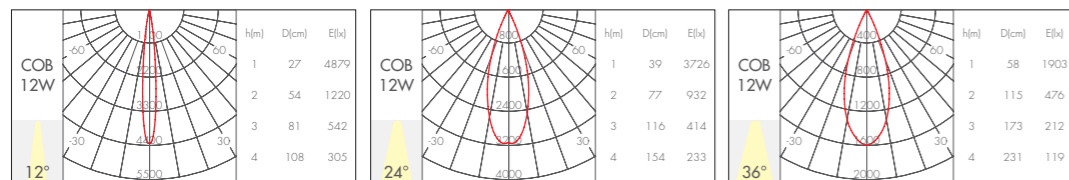

**PRODUCT DATA** 产品参数

Model 型号	Power/CCT 功率 / 色温	Light Output 光通量	Light Efficiency 光效率	CRI 显指	Beam angle 光束角	Cutout 开孔尺寸
IG-XQ608008 02- 反光杯	8W/3000K	≥360 lm	≥45 lm/W	95	15°/24°/36°	Φ80mm
IG-XQ608008 02- 透镜款	8W/3000K	≥480 lm	≥60 lm/W	90	10°/12°/15°/24°/36°/60°*	Φ80mm
IG-XQ608012 02- 反光杯	12W/3000K	≥540 lm	≥45 lm/W	95	15°/24°/36°	Φ80mm
IG-XQ608012 02- 透镜款	12W/3000K	≥651 lm	≥56 lm/W	90	10°/12°/15°/24°/36°/60°*	Φ80mm



**PHOTOMETRIC** 配光参数

反光杯:

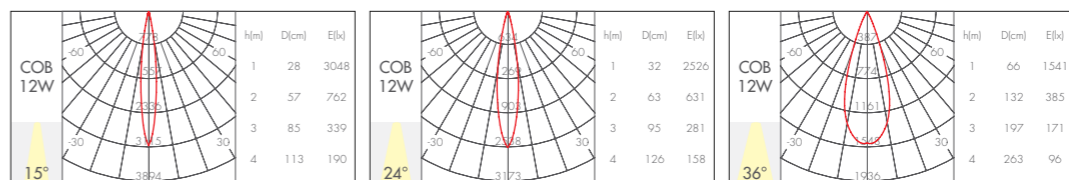

透镜款:

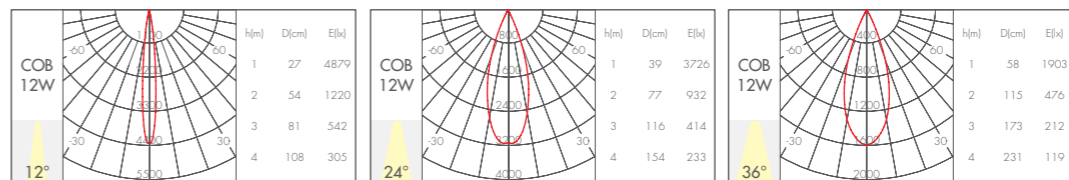



**PRODUCT DATA** 产品参数

Model 型号	Power/CCT 功率/色温	Light Output 光通量	Light Efficiency 光效率	CRI 显指	Beam angle 光束角	Cutout 开孔尺寸
IG-XQ608008 03- 反光杯	8W/3000K	≥280 lm	≥35 lm/W	95	15°/24°/36°	Φ80mm
IG-XQ608008 03- 透镜款	8W/3000K	≥376 lm	≥47 lm/W	90	10°/12°/15°/24°/36°/60°*	Φ80mm
IG-XQ608012 03- 反光杯	12W/3000K	≥420 lm	≥35 lm/W	95	15°/24°/36°	Φ80mm
IG-XQ608012 03- 透镜款	12W/3000K	≥487 lm	≥42 lm/W	90	10°/12°/15°/24°/36°/60°*	Φ80mm



**PHOTOMETRIC** 配光参数

反光杯:

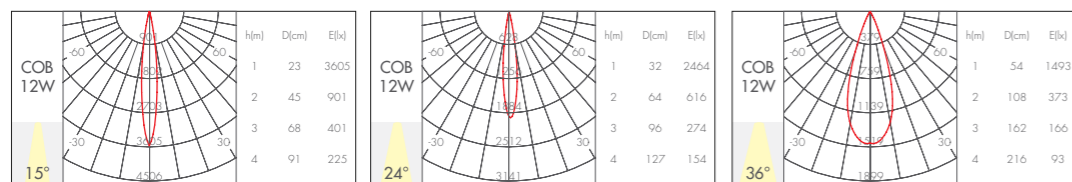

透镜款:

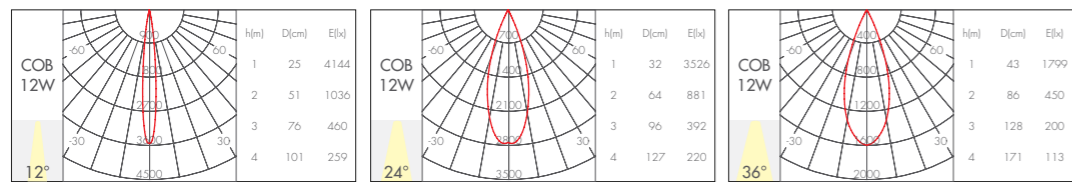

**PRODUCT DATA** 产品参数

Model 型号	Power/CCT 功率/色温	Light Output 光通量	Light Efficiency 光效率	CRI 显指	Beam angle 光束角	Cutout 开孔尺寸
IG-XQ608008 04- 反光杯	8W/3000K	≥240 lm	≥30 lm/W	95	15°/24°/36°	Φ80mm
IG-XQ608008 04- 透镜款	8W/3000K	≥360 lm	≥45 lm/W	90	10°/12°/15°/24°/36°/60°*	Φ80mm
IG-XQ608012 04- 反光杯	12W/3000K	≥360 lm	≥30 lm/W	95	15°/24°/36°	Φ80mm
IG-XQ608012 04- 透镜款	12W/3000K	≥458 lm	≥40 lm/W	90	10°/12°/15°/24°/36°/60°*	Φ80mm



**PHOTOMETRIC** 配光参数

反光杯:

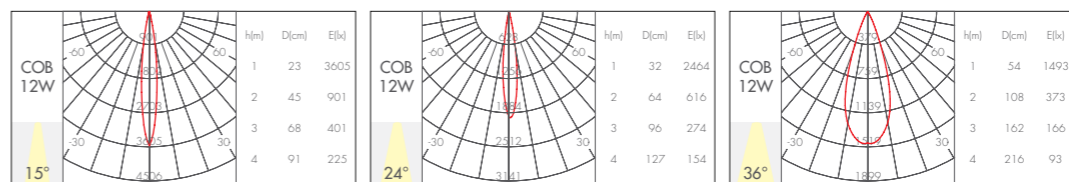

透镜款:

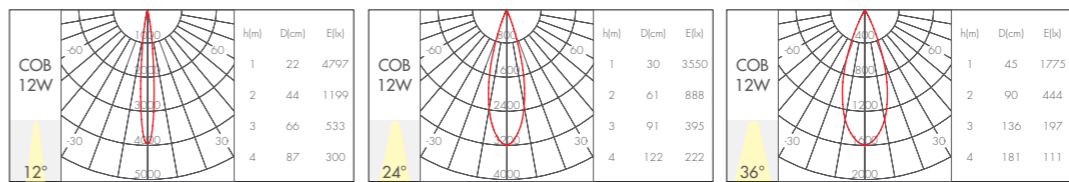

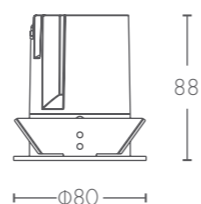

**PRODUCT DATA** 产品参数

Model 型号	Light Source 光源	Power/CCT 功率/色温	Light Output 光通量	Light Efficiency 光效率	Size(DxH) 尺寸	Cutout 开孔尺寸
IG-TH606508 01	COB	8W/3000K	≥440 lm	≥55 lm/W	Φ80x88mm	Φ65mm
IG-TH606512 01	COB	12W/3000K	≥660 lm	≥55 lm/W	Φ80x88mm	Φ65mm



**PHOTOMETRIC** 配光参数

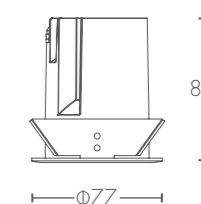
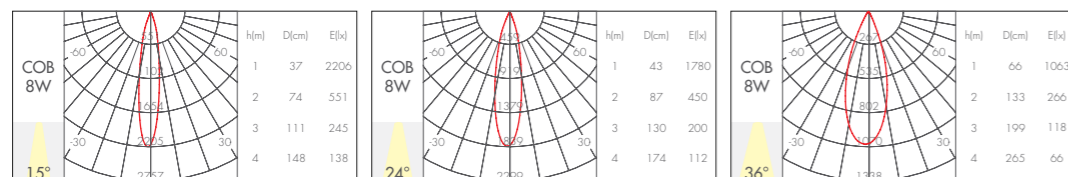

**PRODUCT DATA** 产品参数

Model 型号	Light Source 光源	Power/CCT 功率/色温	Light Output 光通量	Light Efficiency 光效率	Size(DxH) 尺寸	Cutout 开孔尺寸
IG-TH606508 04	COB	8W/3000K	≥240 lm	≥30 lm/W	Φ77x85mm	Φ65mm
IG-TH606512 04	COB	12W/3000K	≥360 lm	≥30 lm/W	Φ77x85mm	Φ65mm

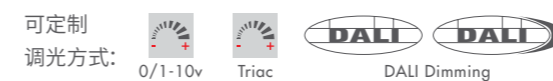

**PHOTOMETRIC** 配光参数

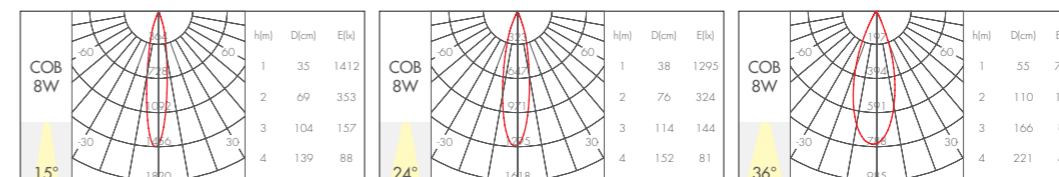

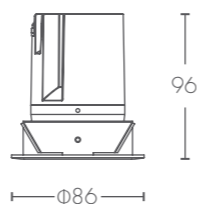
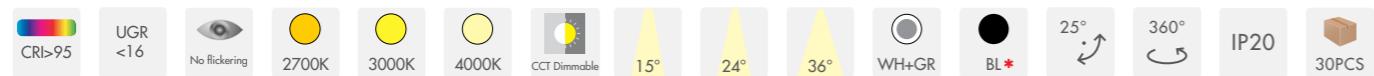

**PRODUCT DATA** 产品参数

Model 型号	Light Source 光源	Power/CCT 功率 / 色温	Light Output 光通量	Light Efficiency 光效率	Size(DxH) 尺寸	Cutout 开孔尺寸
IG-TH607508 02	COB	8W/3000K	≥440 lm	≥55 lm/W	Φ86x96mm	Φ75mm
IG-TH607512 02	COB	12W/3000K	≥660 lm	≥55 lm/W	Φ86x96mm	Φ75mm



**PHOTOMETRIC** 配光参数

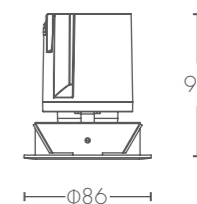
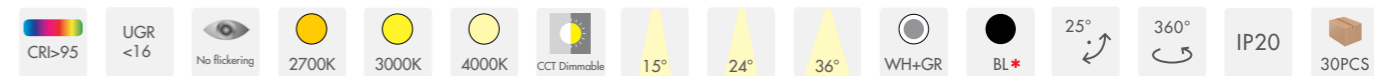
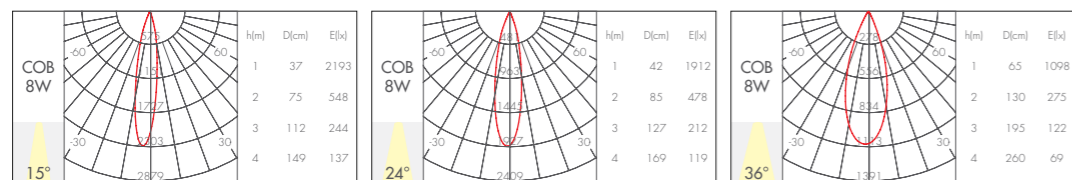

**PRODUCT DATA** 产品参数

Model 型号	Light Source 光源	Power/CCT 功率 / 色温	Light Output 光通量	Light Efficiency 光效率	Size(DxH) 尺寸	Cutout 开孔尺寸
IG-TH607508 03	COB	8W/3000K	≥240 lm	≥30 lm/W	Φ86x99mm	Φ75mm
IG-TH607512 03	COB	12W/3000K	≥360 lm	≥30 lm/W	Φ86x99mm	Φ75mm



**PHOTOMETRIC** 配光参数

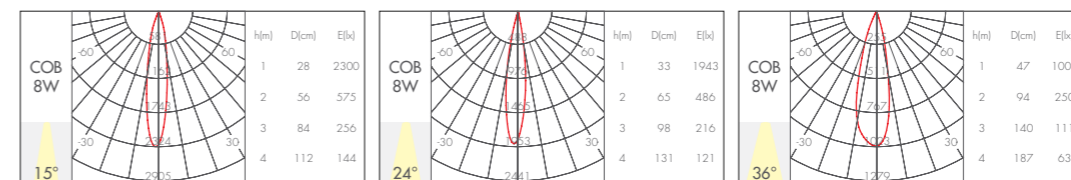

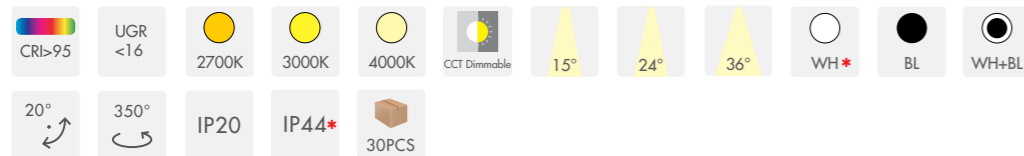

可定制白色罩子 \*

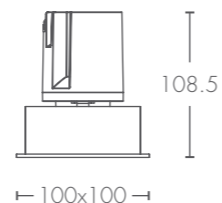

**PRODUCT DATA** 产品参数

Model 型号	Light Source 光源	Power/CCT 功率/色温	Light Output 光通量	Light Efficiency 光效率	Size(WxLxH) 尺寸	Cutout 开孔尺寸
IG-GS609508 01	COB	8W/3000K	≥320 lm	≥40 lm/W	100x100x108.5mm	95x95mm
IG-GS609512 01	COB	12W/3000K	≥480 lm	≥40 lm/W	100x100x108.5mm	95x95mm



**PHOTOMETRIC** 配光参数

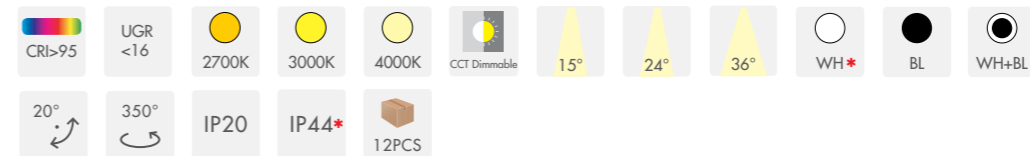
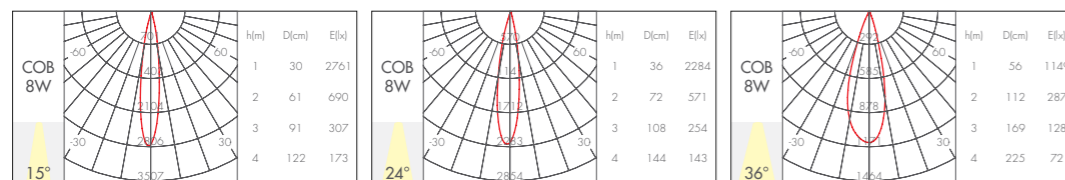

可定制白色罩子 \*

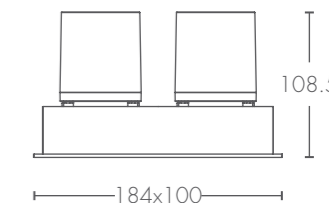

**PRODUCT DATA** 产品参数

Model 型号	Light Source 光源	Power/CCT 功率/色温	Light Output 光通量	Light Efficiency 光效率	Size(WxLxH) 尺寸	Cutout 开孔尺寸
IG-GS609516 02	COB	2x8W/3000K	≥640 lm	≥40 lm/W	184x100x108.5mm	175x95mm
IG-GS609524 02	COB	2x12W/3000K	≥960 lm	≥40 lm/W	184x100x108.5mm	175x95mm

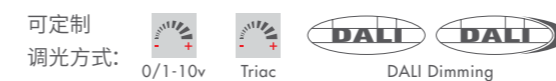

**PHOTOMETRIC** 配光参数

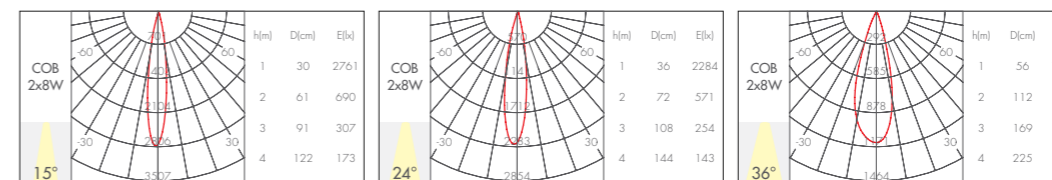

THE NEW  
AKARI 2595



柔光双反·点亮你的美

极致柔和，中空照明小钢炮，开孔 95mm，最大功率可达到 25W

满足不同层高照明需求，达到空间舒适和视觉舒适的统一



# No.1 第一反

## 漫光反射

光效经过二代柔光镜片，镜片把多余的杂光过滤掉

凝聚光线，光斑更加均匀饱满

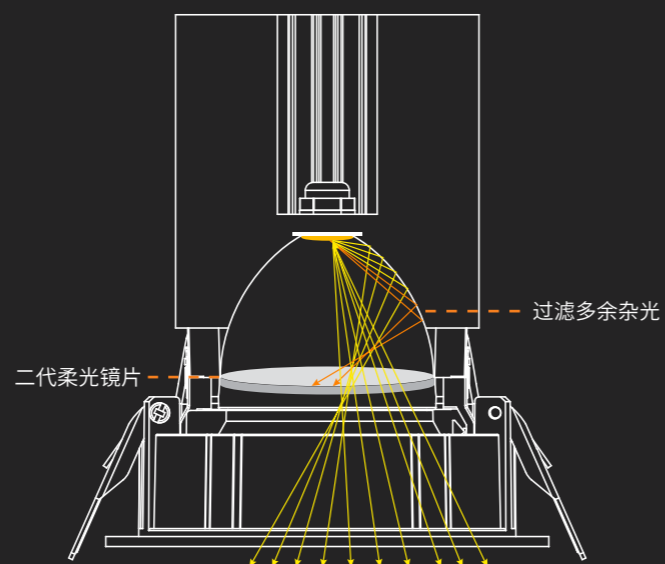

# 经典预埋结构

采用分体式预制，可选择预埋式安装或整体安装方式，

安装维护更方便快捷，拒绝损坏灯具、天花



# No.1 第二反

## 黑光反射

二代黑光反射器，确保光源反射效率，

防止反射器制造二次眩光

使灯具点亮时反射器保持无眩光，

避免造成天花视觉紊乱

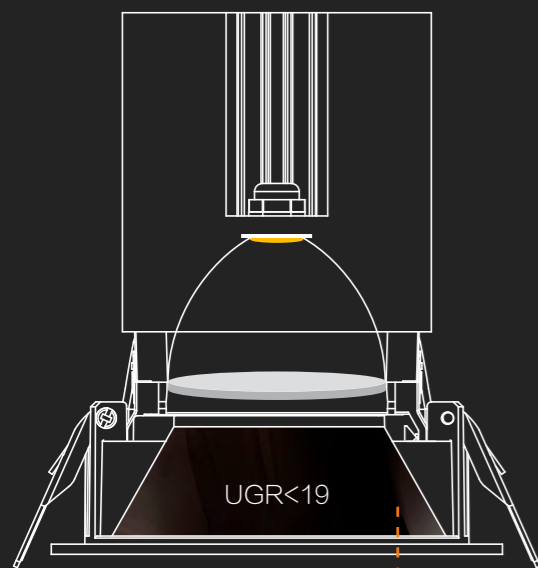

二代黑光反射器

# 国韵散热结构

家族化散热器造型，选用进口超高导热铝材散热

冷空气从散热器下部进入，经过合理分布的散热鳍片，

最大程度把热量快速带走





## 真正的柔和光线

光斑均匀过渡,从100%-20%光强之间,没有特别明显的明暗对比,  
得益于柔光双反技术,使光斑的渐层效果完美自然。  
(图片为 25W, 24° 阿卡丽 2595 实拍效果)

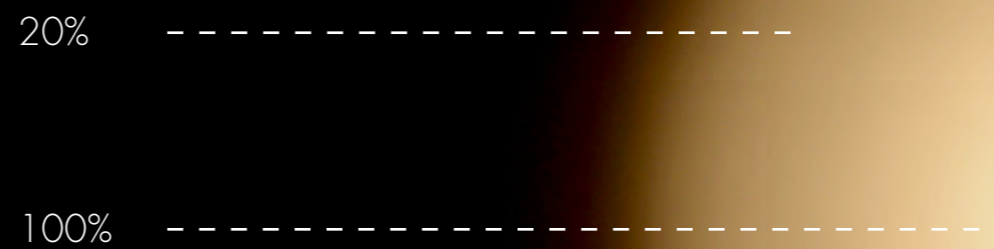

# 点亮你的美

柔和分布，光型更自然

(图片为 25W, 24° 阿卡丽 2595 实拍效果)

## 刻度标识，调试精准

增加旋转角度刻度标识，使调整空间灯体摆角，统一光斑更为方便，利于创造一个柔和有序的光照环境，可调角度：垂直方向 30°，水平方向 355°

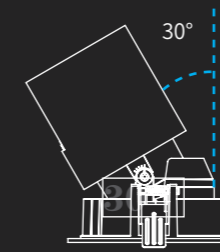

灯体倾斜角度最大为 30°

## 漫光反射

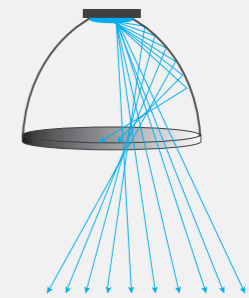

- ✓ 柔和分布
- ✓ 光型更自然
- ✓ 凝聚光线，光斑更加均匀饱满

## 适用 3.2 至 6 米高度空间

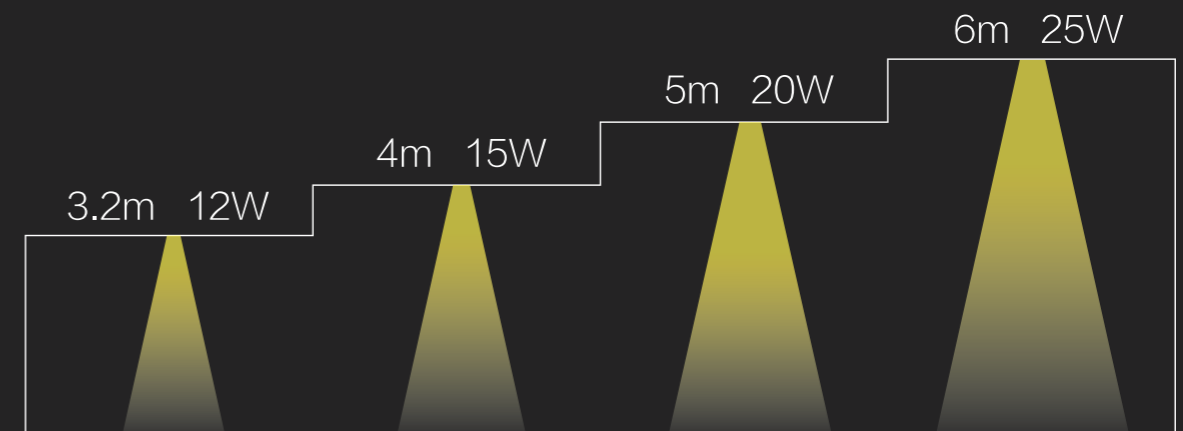



- UGR <16
- No flickering
- 2700K
- 3000K
- 4000K
- CCT Dimmable
- WH+GR
- BL\*
- 30°
- 350°
- IP20
- 12PCS



### PRODUCT DATA 产品参数

Model 型号	Power/CCT 功率 / 色温	Light Output 光通量	Light Efficiency 光效率	CRI 显指	Beam 光束角	Cutout 开孔尺寸
IG-XQ609512 01- 反光杯	12W/3000K	≥660 lm	≥35 lm/W	90	15°/24°/38°/60°	Φ95mm
IG-XQ609515 01- 反光杯	15W/3000K	≥990 lm	≥55 lm/W	90	15°/24°/38°/60°	Φ95mm
IG-XQ609520 01- 反光杯	20W/3000K	≥1100 lm	≥55 lm/W	90	15°/24°/38°/60°	Φ95mm
IG-XQ609520 01- 透镜款	20W/3000K	≥1281 lm	≥59 lm/W	90	12°/15°/24°/36°/60°*	Φ95mm
IG-XQ609525 01- 反光杯	25W/3000K	≥1375 lm	≥55 lm/W	90	15°/24°/38°/60°	Φ95mm

可定制  
调光方式:



配件  
可选项:



### PHOTOMETRIC 配光参数

反光杯:

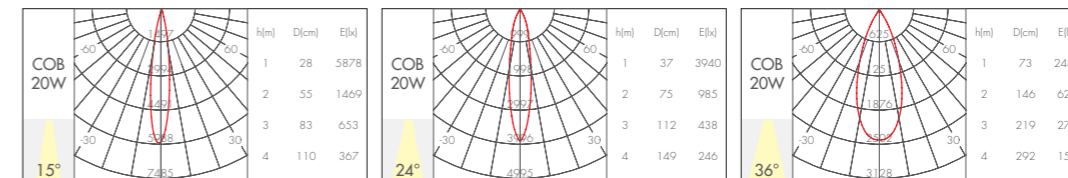

透镜款:

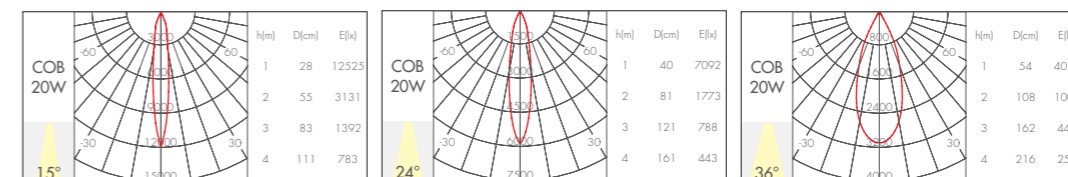

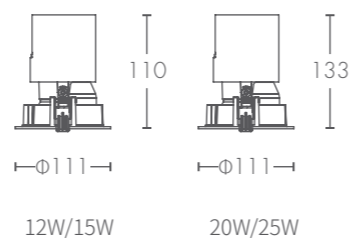

**PRODUCT DATA** 产品参数

Model 型号	Power/CCT 功率 / 色温	Light Output 光通量	Light Efficiency 光效率	CRI 显指	Beam 光束角	Cutout 开孔尺寸
IG-XQ609512 02-反光杯	12W/3000K	≥720 lm	≥60 lm/W	90	15°/24°/38°/60°	Φ95mm
IG-XQ609515 02-反光杯	15W/3000K	≥900 lm	≥60 lm/W	90	15°/24°/38°/60°	Φ95mm
IG-XQ609520 02-反光杯	20W/3000K	≥1200 lm	≥60 lm/W	90	15°/24°/38°/60°	Φ95mm
IG-XQ609520 02-透镜款	20W/3000K	≥1399 lm	≥64 lm/W	90	12°/15°/24°/36°/60°*	Φ95mm
IG-XQ609525 02-反光杯	25W/3000K	≥1500 lm	≥60 lm/W	90	15°/24°/38°/60°	Φ95mm



**PHOTOMETRIC** 配光参数

反光杯:

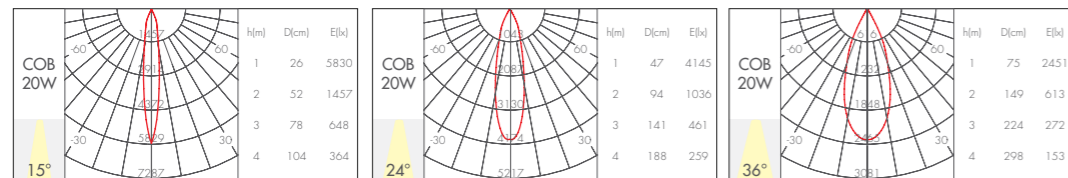

透镜款:

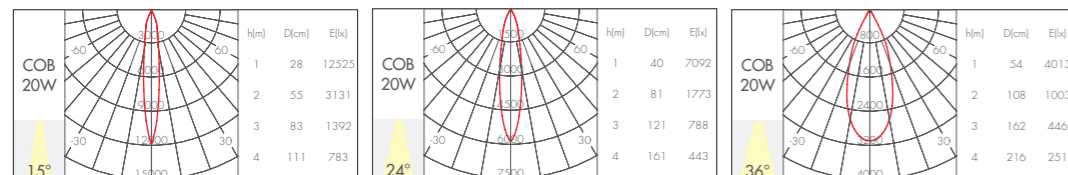



# AKARI 凌

## 方形深防眩射灯

方形射灯，更易与天花板造型融合，

搭配防眩柔和的光效，给你带来极致的视觉体验

# 预埋分体结构

窄边框，无边框两种安装方式可选，  
安全钢丝吊线，维护安全方便

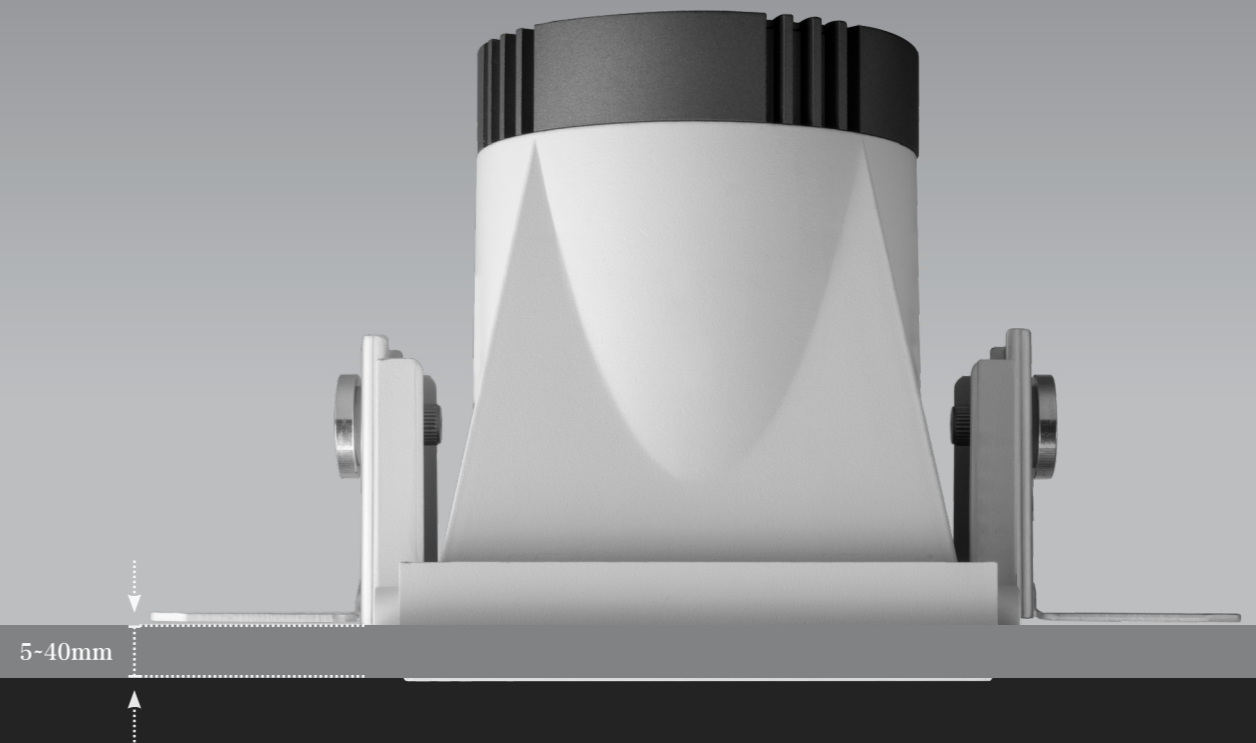
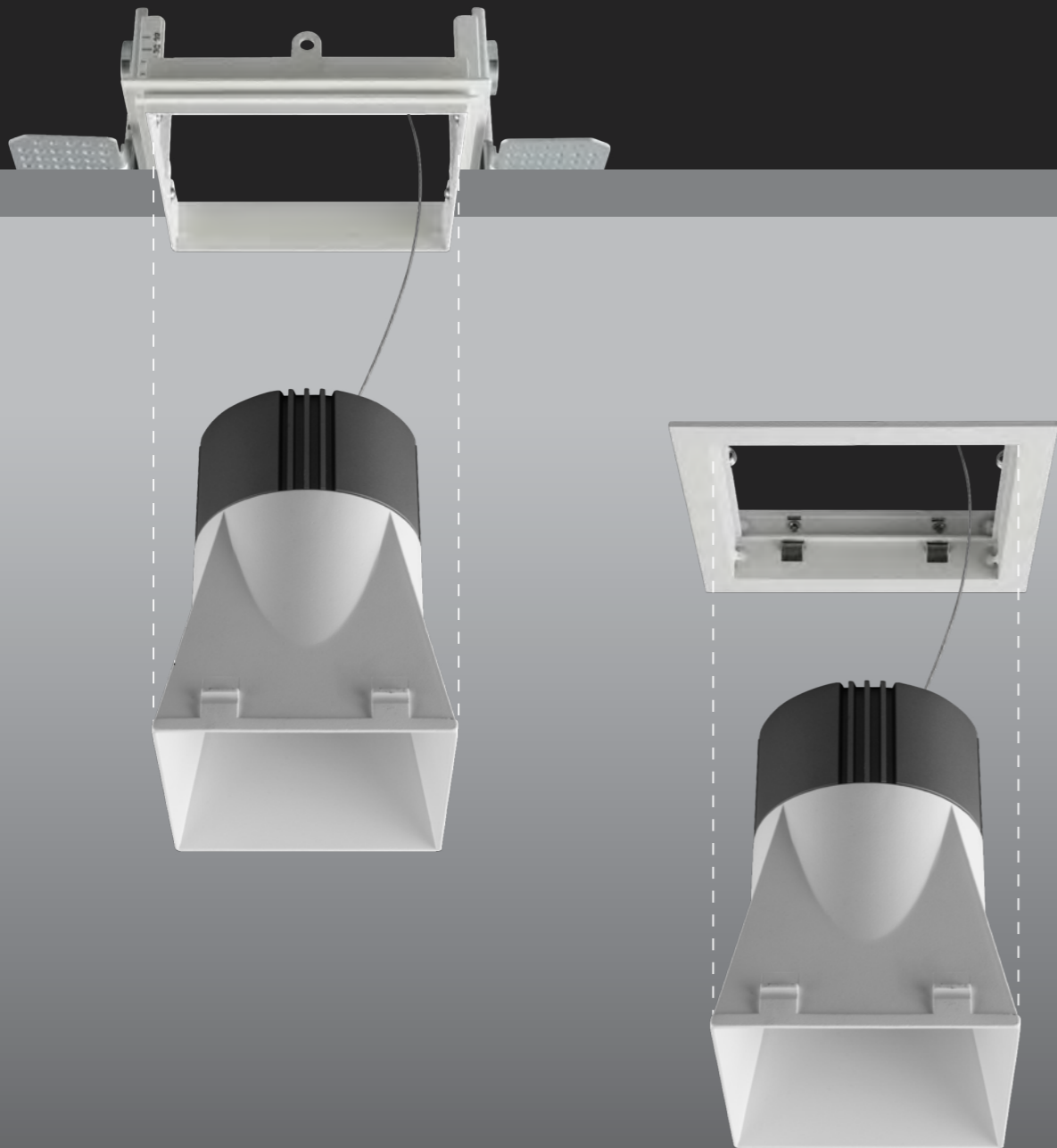

## 有刻度，更克制

旋转螺丝可适应于 5-40mm 厚度的天花板  
凌系列覆盖 8W/12W/15W/20W/25W，  
适合层高 2.8m-4.0m



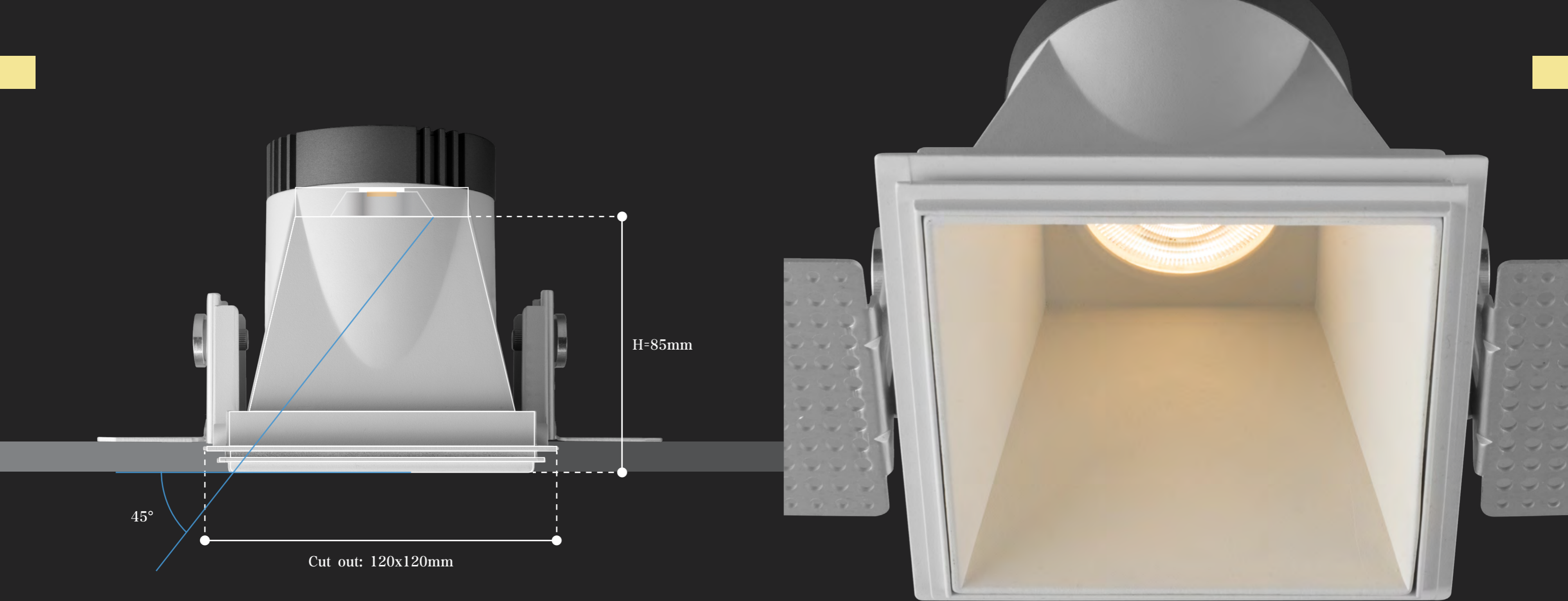

## 80mm 的防眩

在有限的灯体高度下，创造出极致的深藏防眩效果

光源离出光口 80mm，防眩角度 45°

## 深藏 · 柔光

深防眩结构 + 菲尼尔柔光透镜，组成完美视觉体验

# 方·圆

*Square · Circular*

方形出光口 - 圆形光斑，一如既往的精准配光



# 凌·动组合

*Smart combination*

黑白双色，方形造型更能融合天花板造型





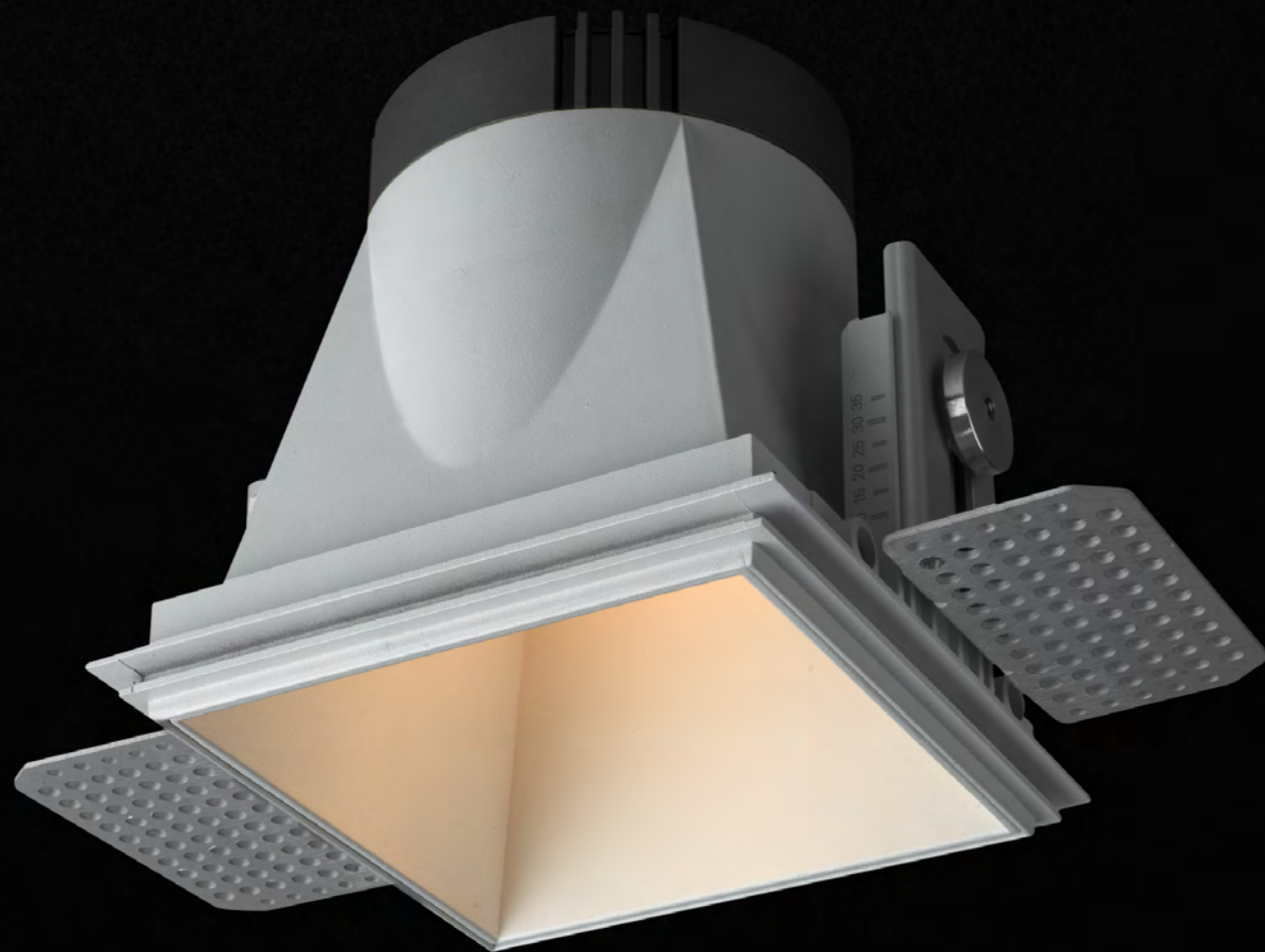

- 
- 
- 
- 
- 
- 
- 
- 
- 
- 
- 
- 
- 
- 

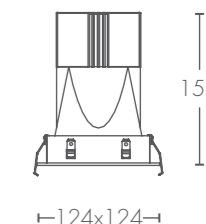

### PRODUCT DATA 产品参数

Model 型号	Light Source 光源	Power/CCT 功率 / 色温	Light Output 光通量	Light Efficiency 光效率	Size(WxLxH) 尺寸	Cutout 开孔尺寸
IG-TD611015	COB	15W/3000K	≥975 lm	≥65 lm/W	124x124x155mm	110x110mm
IG-TD611020	COB	20W/3000K	≥1300 lm	≥65 lm/W	124x124x155mm	110x110mm
IG-TD611025	COB	25W/3000K	≥1625 lm	≥65 lm/W	124x124x155mm	110x110mm

可定制  
调光方式:

### PHOTOMETRIC 配光参数

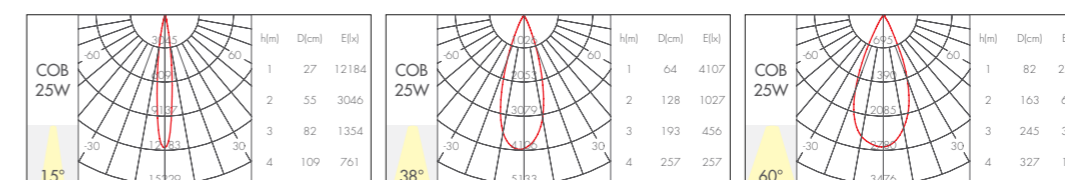

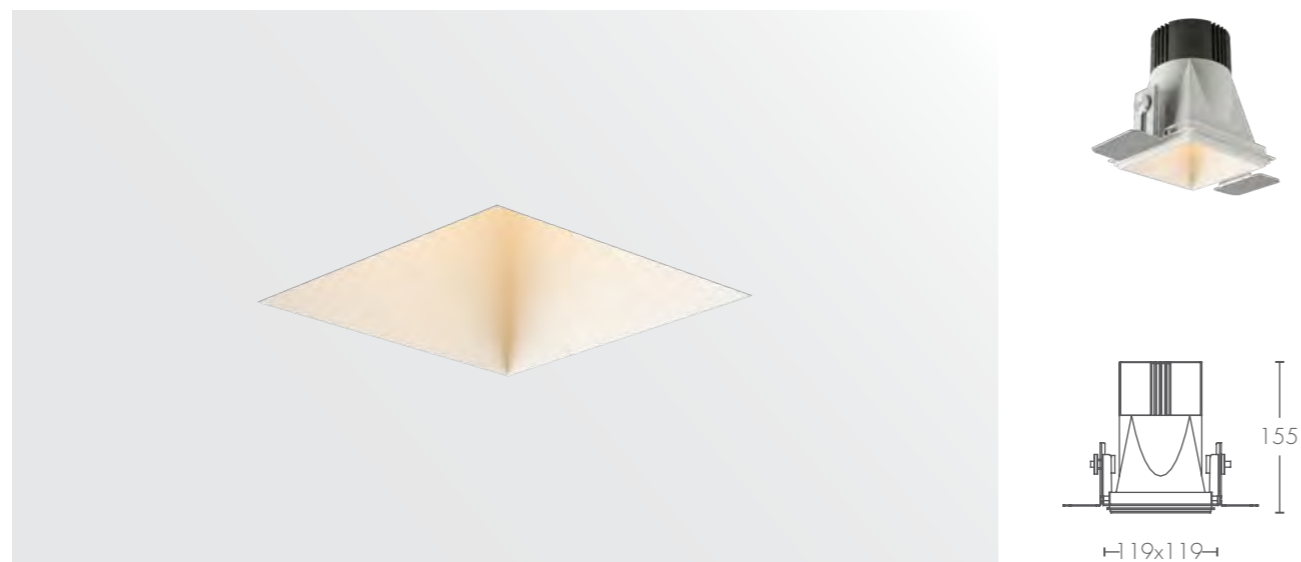
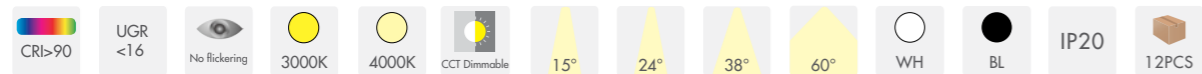

**PRODUCT DATA** 产品参数

Model 型号	Light Source 光源	Power/CCT 功率 / 色温	Light Output 光通量	Light Efficiency 光效率	Size(WxLxH) 尺寸	Cutout 开孔尺寸
IG-TD612015	COB	15W/3000K	≥975 lm	≥65 lm/W	119x119x155mm	120x120mm
IG-TD612020	COB	20W/3000K	≥1300 lm	≥65 lm/W	119x119x155mm	120x120mm
IG-TD612025	COB	25W/3000K	≥1625 lm	≥65 lm/W	119x119x155mm	120x120mm



**PHOTOMETRIC** 配光参数

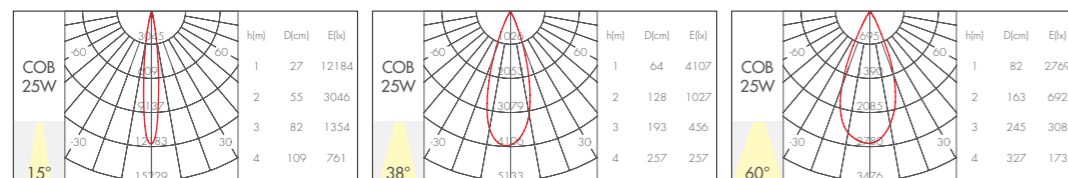

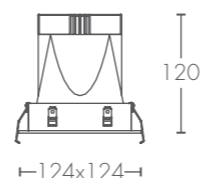
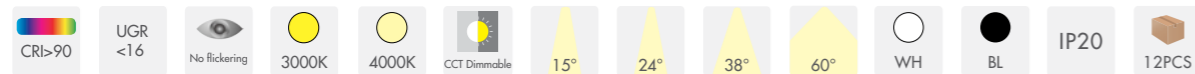

**PRODUCT DATA** 产品参数

Model 型号	Light Source 光源	Power/CCT 功率 / 色温	Light Output 光通量	Light Efficiency 光效率	Size(WxLxH) 尺寸	Cutout 开孔尺寸
IG-TD611008	COB	8W/3000K	≥710 lm	≥88 lm/W	124x124x120mm	110x110mm
IG-TD611012	COB	12W/3000K	≥860 lm	≥72 lm/W	124x124x120mm	110x110mm



**PHOTOMETRIC** 配光参数

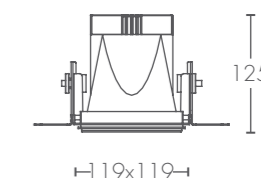
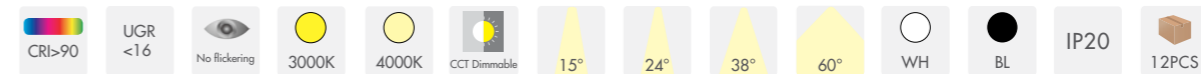
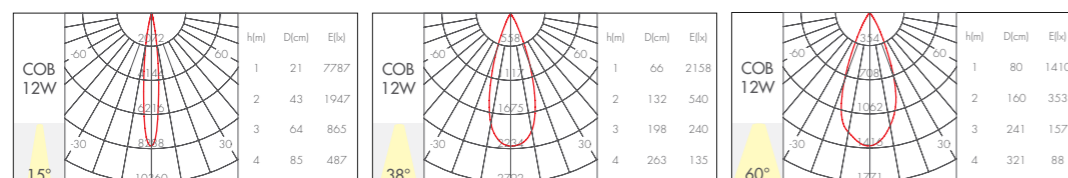

**PRODUCT DATA** 产品参数

Model 型号	Light Source 光源	Power/CCT 功率 / 色温	Light Output 光通量	Light Efficiency 光效率	Size(WxLxH) 尺寸	Cutout 开孔尺寸
IG-TD612008	COB	8W/3000K	≥710 lm	≥88 lm/W	119x119x125mm	120x120mm
IG-TD612012	COB	12W/3000K	≥860 lm	≥72 lm/W	119x119x125mm	120x120mm



**PHOTOMETRIC** 配光参数

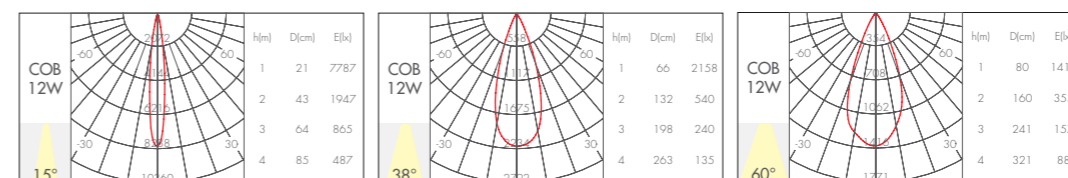

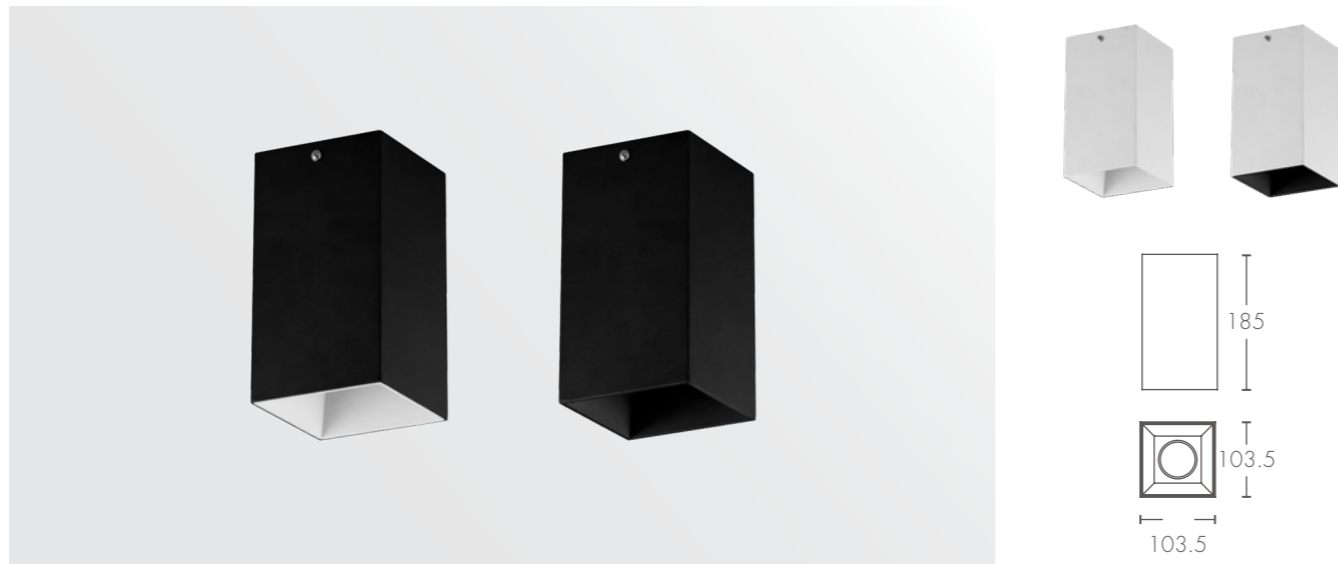

**PRODUCT DATA** 产品参数

Model 型号	Light Source 光源	Power/CCT 功率 / 色温	Light Output 光通量	Light Efficiency 光效率	Size(WxLxH) 尺寸	Installation 安装方式
IG-MT010415	COB	15W/3000K	≥975 lm	≥65 lm/W	103.5x103.5x185mm	明装式
IG-MT010420	COB	20W/3000K	≥1300 lm	≥65 lm/W	103.5x103.5x185mm	明装式
IG-MT010425	COB	25W/3000K	≥1625 lm	≥65 lm/W	103.5x103.5x185mm	明装式



**PHOTOMETRIC** 配光参数

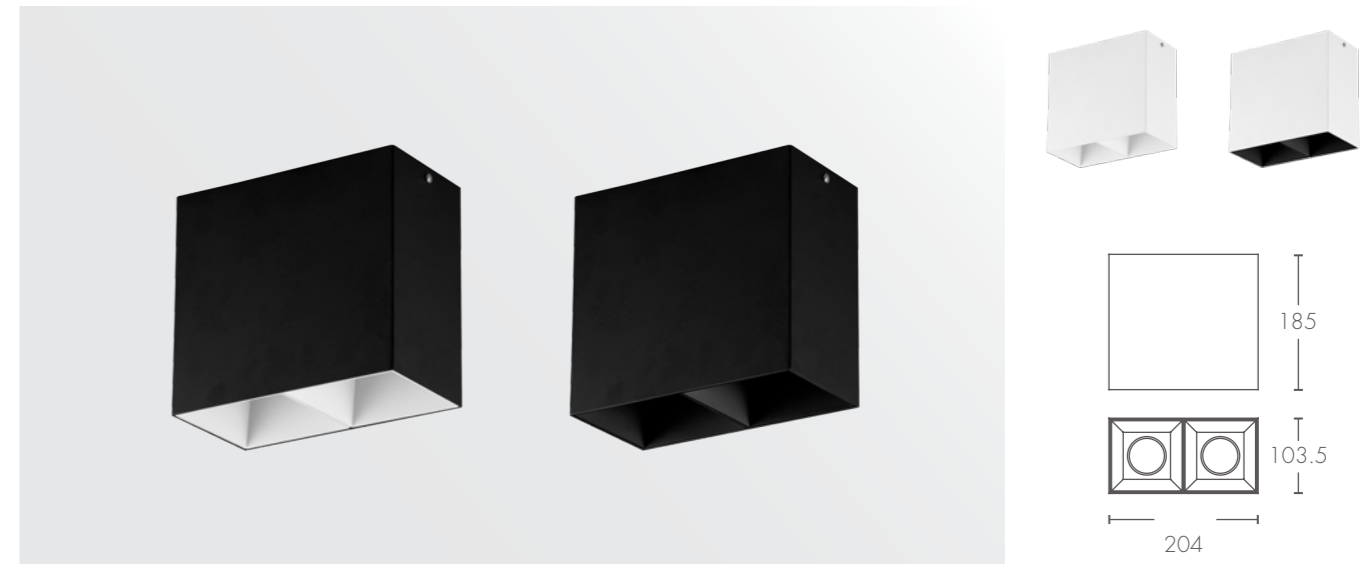
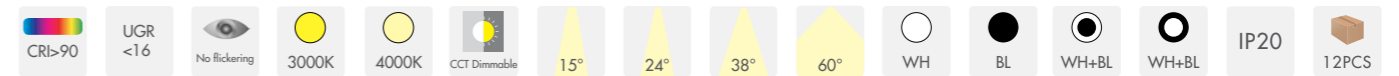
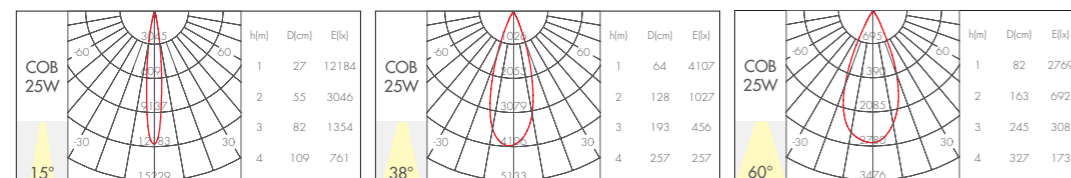

**PRODUCT DATA** 产品参数

Model 型号	Light Source 光源	Power/CCT 功率 / 色温	Light Output 光通量	Light Efficiency 光效率	Size(WxLxH) 尺寸	Installation 安装方式
IG-MT020430	COB	2x15W/3000K	≥1950 lm	≥65 lm/W	204x103.5x185mm	明装式
IG-MT020440	COB	2x20W/3000K	≥2600 lm	≥65 lm/W	204x103.5x185mm	明装式
IG-MT020450	COB	2x25W/3000K	≥3250 lm	≥65 lm/W	204x103.5x185mm	明装式

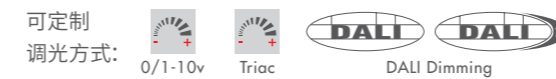

**PHOTOMETRIC** 配光参数

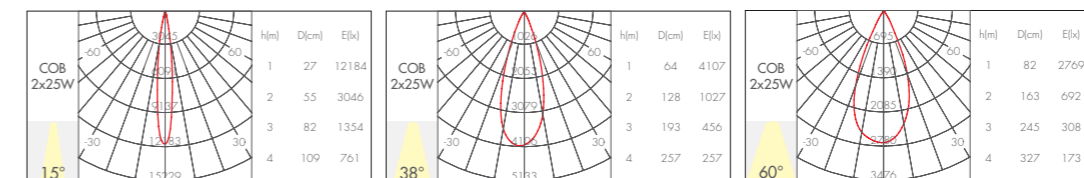



**AKARI** 华宇

## 高空大功率洗墙射灯

大功率 30W/35W/40W 可供选择

搭配防眩柔和的光效，给你带来极致的视觉体验

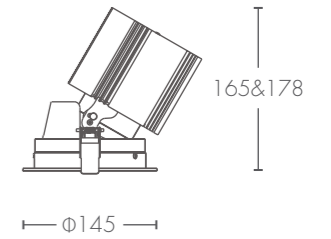
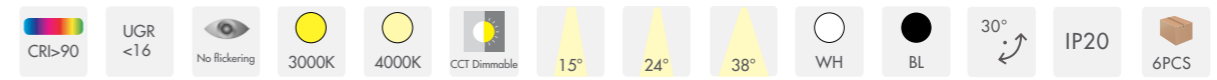

**PRODUCT DATA** 产品参数

Model 型号	Light Source 光源	Power/CCT 功率 / 色温	Light Output 光通量	Light Efficiency 光效率	Size(DxH) 尺寸	Cutout 开孔尺寸
IG-XQ613030 01	COB	30W/3000K	≥1950 lm	≥65 lm/W	Φ145x165mm	Φ130mm
IG-XQ613035 01	COB	35W/3000K	≥2275 lm	≥65 lm/W	Φ145x178mm	Φ130mm
IG-XQ613040 01	COB	40W/3000K	≥2600 lm	≥65 lm/W	Φ145x178mm	Φ130mm

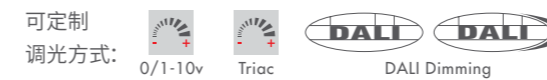

**PHOTOMETRIC** 配光参数

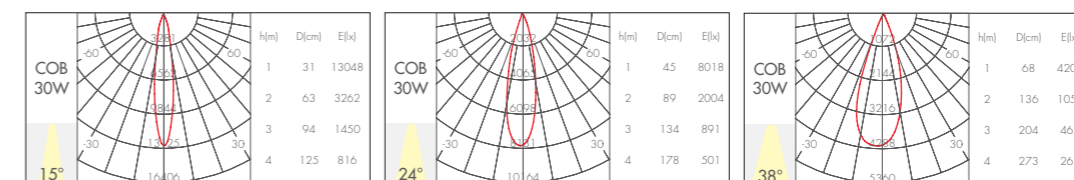

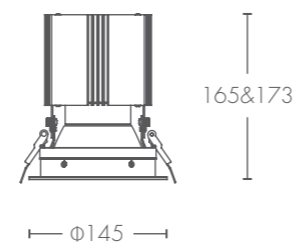

**PRODUCT DATA** 产品参数

Model 型号	Light Source 光源	Power/CCT 功率 / 色温	Light Output 光通量	Light Efficiency 光效率	Size(DxH) 尺寸	Cutout 开孔尺寸
IG-XQ613030 02	COB	30W/3000K	≥1950 lm	≥65 lm/W	Φ145x165mm	Φ130mm
IG-XQ613035 02	COB	35W/3000K	≥2275 lm	≥65 lm/W	Φ145x173mm	Φ130mm
IG-XQ613040 02	COB	40W/3000K	≥2600 lm	≥65 lm/W	Φ145x173mm	Φ130mm



**PHOTOMETRIC** 配光参数

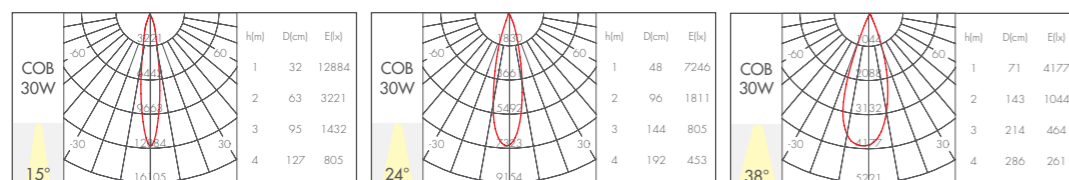



# AKARI MOON

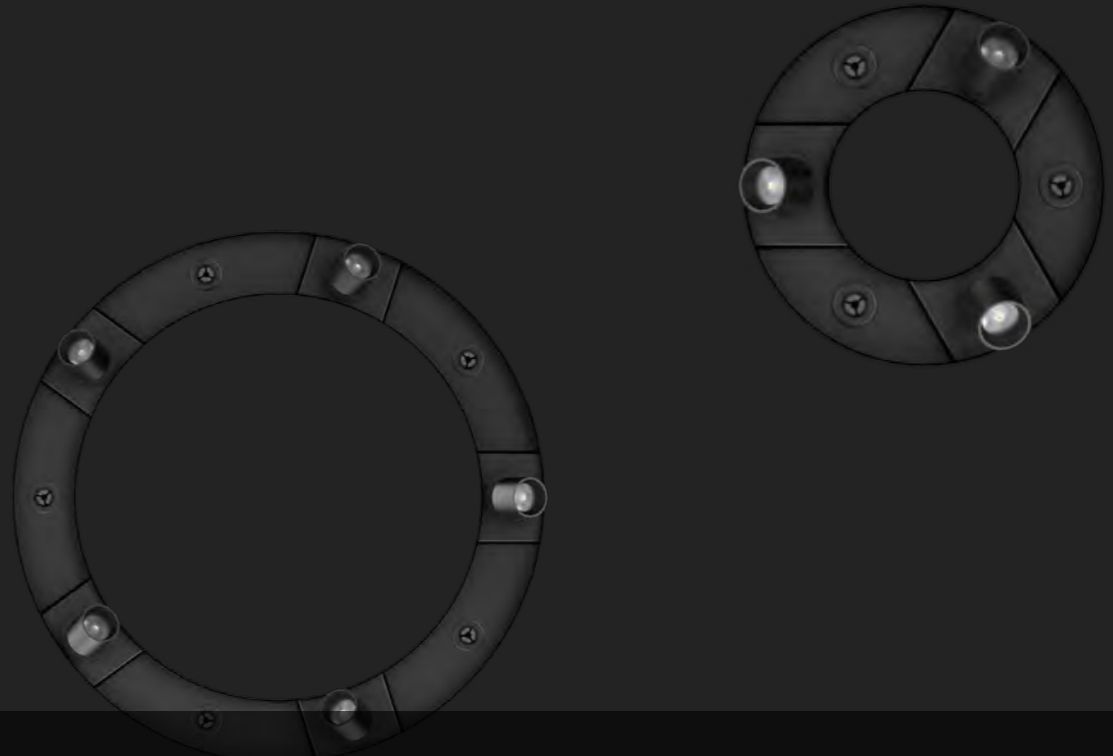

## 照亮心田之光

在有限的灯体高度下，创造极致的深藏防眩效果  
多种尺寸规格，组合成不同的空间形式  
Φ300 / Φ600 / Φ900 / Φ1200mm





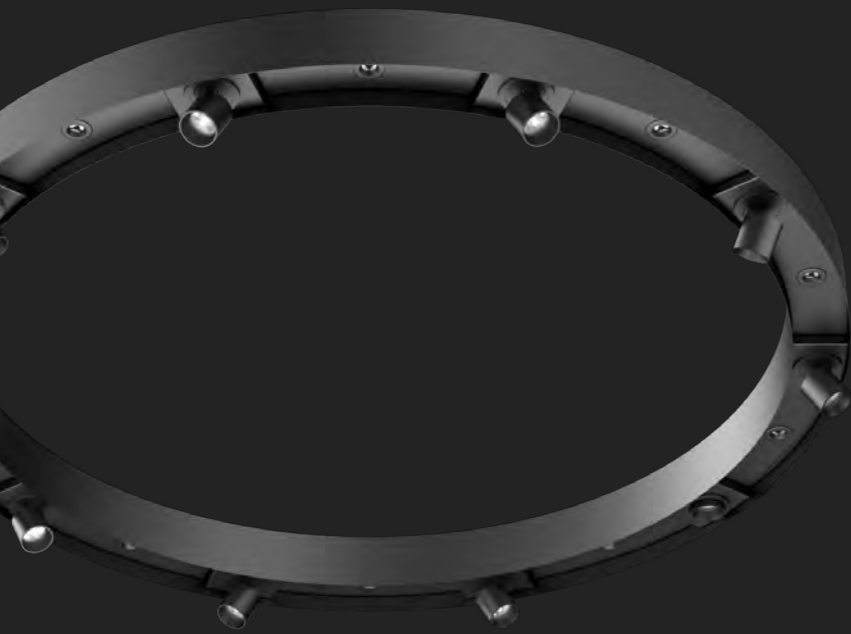

Mini Spot + Adjustable Spot

微光射灯 + 可调射灯

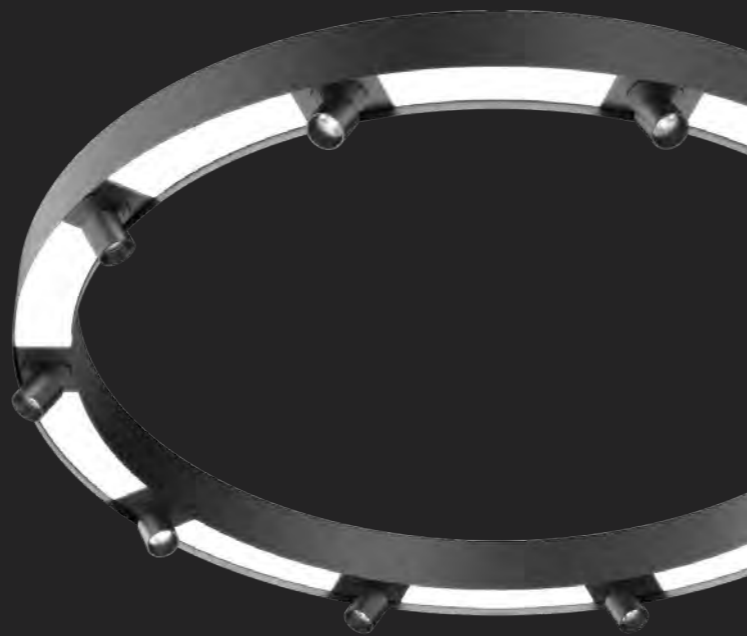

Flood Light + Adjustable Spot

泛光照明 + 可调射灯

## 多功能现代装饰灯

时尚百搭，适合多种不同场景，满足您的需求

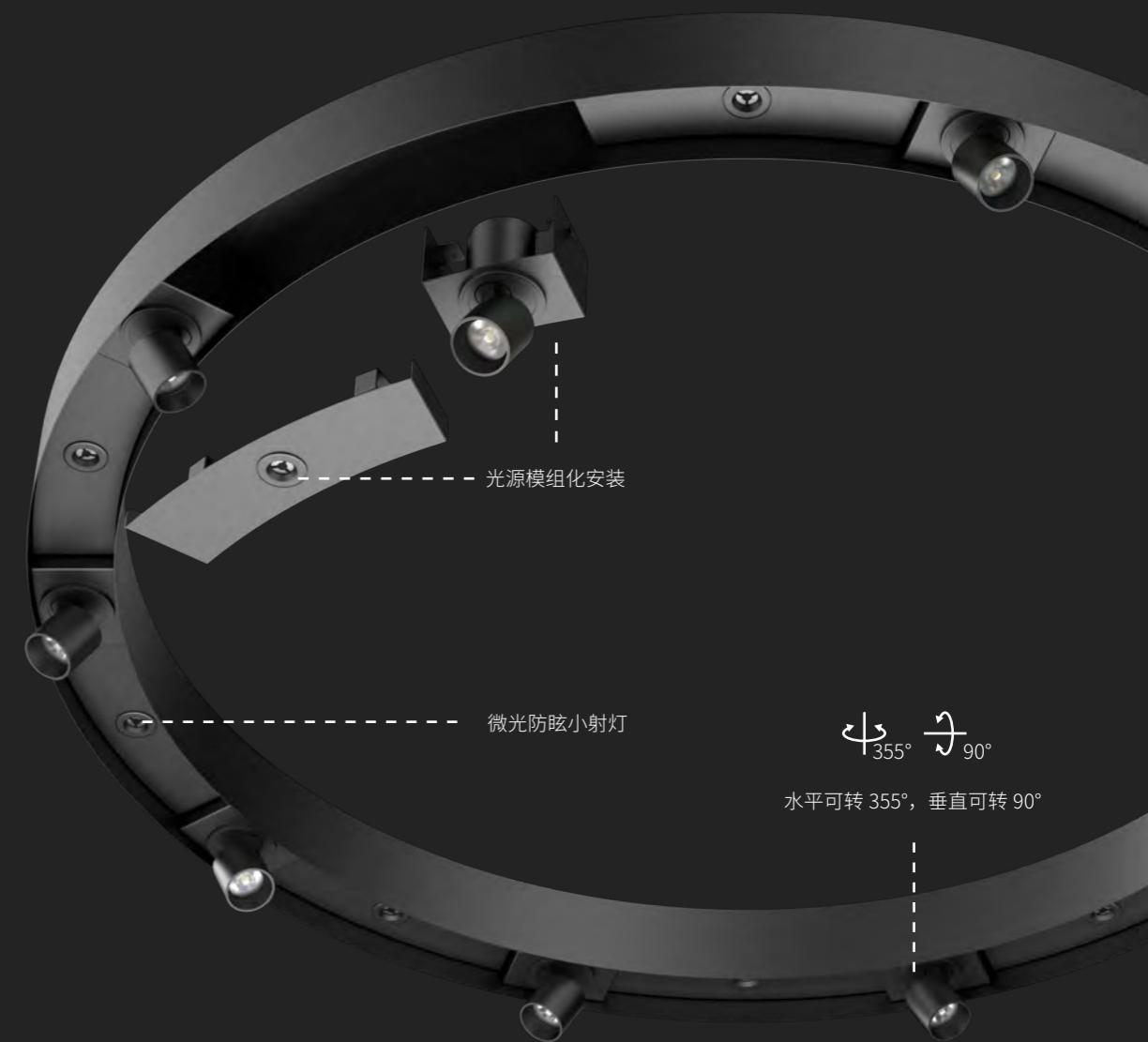

光源模组化安装

微光防眩小射灯

水平可转 355°，垂直可转 90°

## 多种照明方式

工业照明、家居照明、商业照明的完美融合

6W 可调射灯 + 3W 微光小王子

组合出多种照明方式



平衡交错安装模式

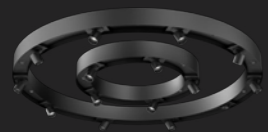

水平重叠安装模式

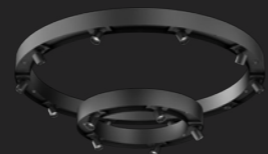

高低重叠安装模式

## 多种安装模式

适用于：酒店，别墅，民宿，办公室等各类现代商业空间



## 三种安装方式

可嵌入式安装、吊线式安装和吸顶式安装

适合所有高低楼层



# 智能分段控制

阿卡丽-梦 的不同照明组合  
能组合出多种照明方式



木木

如月之雅  
如梦轻抚

- CRI>90
- UGR <19
- No flickering
- 3000K
- 4000K
- 10°
- 15°
- 24°
- 36°
- BL
- 90°
- 355°
- IP20
- 1PCS



**PRODUCT DATA** 产品参数

Model 型号	Light Source 光源	Power/CCT 功率 / 色温	Light Output 光通量	Light Efficiency 光效率	Size(DxH) 尺寸	Installation 安装方式
IG-MS630027	COB/SMD	3x6W+3x3W/3000K	≥3x408 lm+3x155 lm	≥3x69 lm/W+3x52 lm/W	Φ300x80mm	吊线式 嵌入式 吸顶式

**SINGLE PHOTOMETRIC** 单头 6W 配光参数

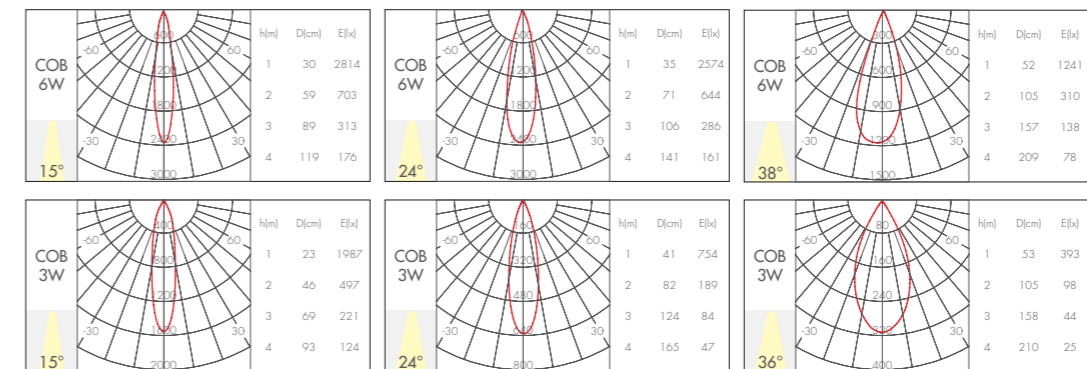

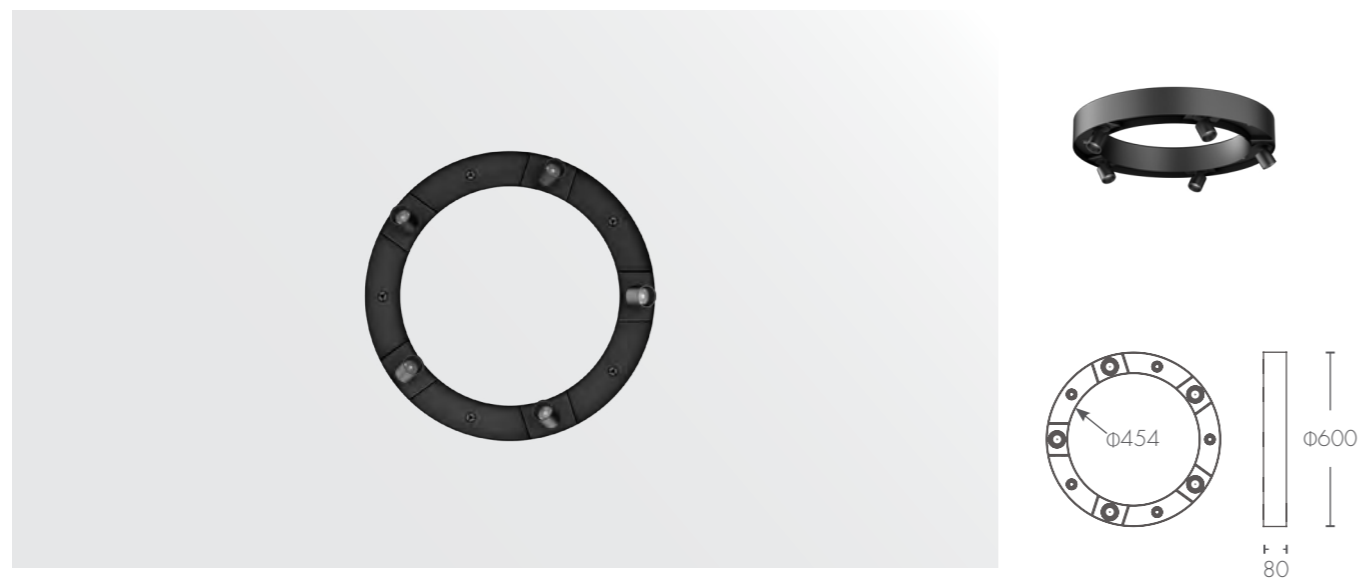
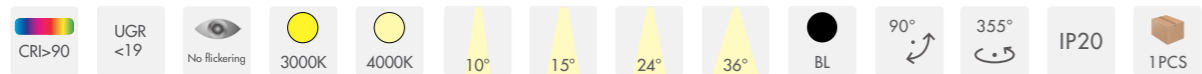

**PRODUCT DATA** 产品参数

Model 型号	Light Source 光源	Power/CCT 功率/色温	Light Output 光通量	Light Efficiency 光效率	Size(DxH) 尺寸	Installation 安装方式
IG-MS660045	COB/SMD	5x6W+5x3W/3000K	≥5x408 lm+5x155 lm	≥5x69 lm/W+5x52 lm/W	Φ600x80mm	吊线式 嵌入式 吸顶式

**SINGLE PHOTOMETRIC** 单头 6W 配光参数

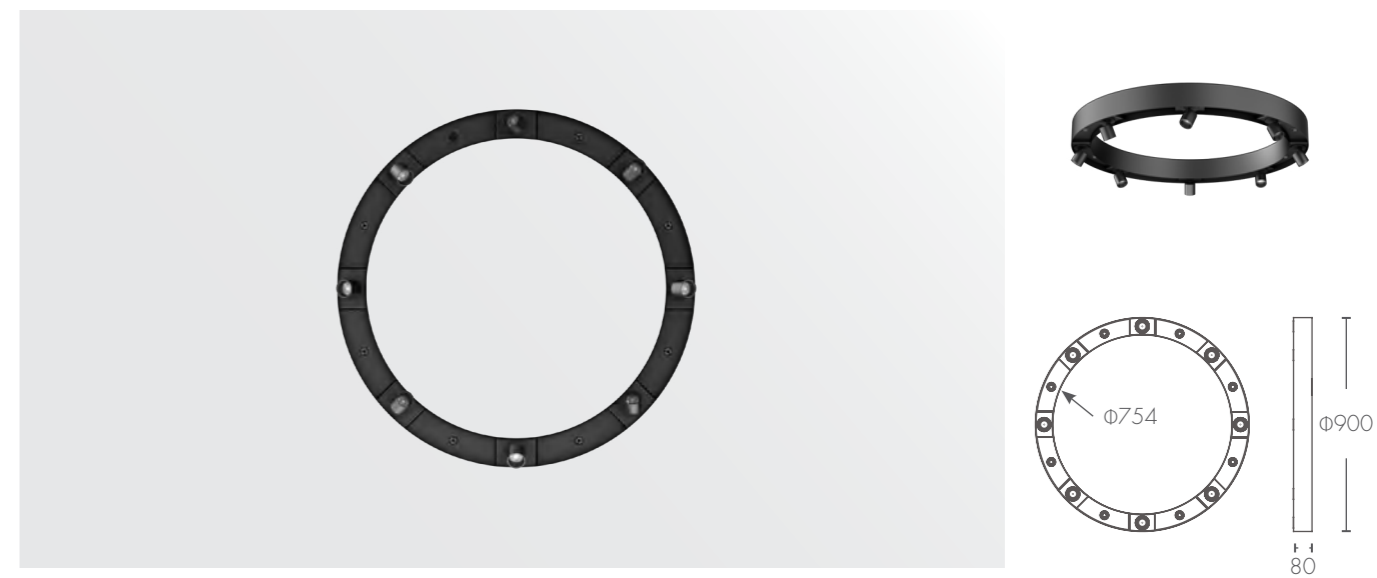
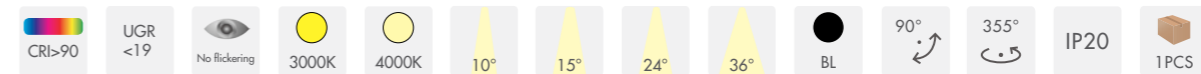
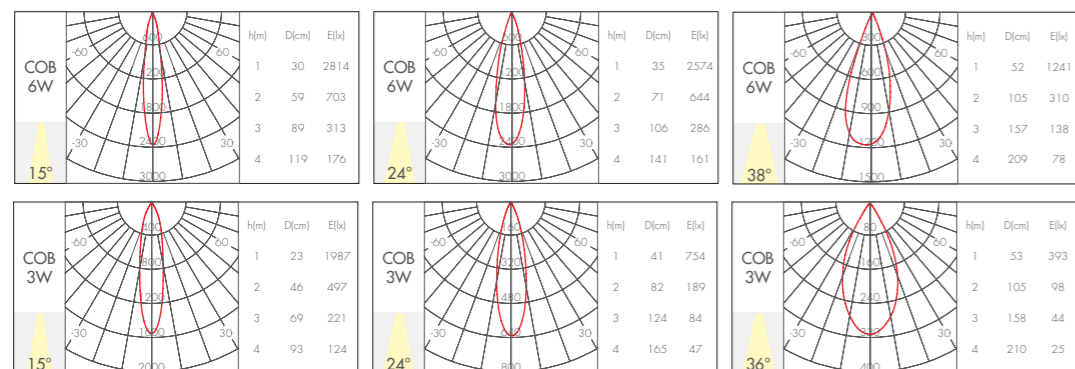

**PRODUCT DATA** 产品参数

Model 型号	Light Source 光源	Power/CCT 功率/色温	Light Output 光通量	Light Efficiency 光效率	Size(DxH) 尺寸	Installation 安装方式
IG-MS690072	COB/SMD	8x6W+8x3W/3000K	≥8x408 lm+8x155 lm	≥8x69 lm/W+8x52 lm/W	Φ900x80mm	吊线式 嵌入式 吸顶式

**SINGLE PHOTOMETRIC** 单头 6W 配光参数

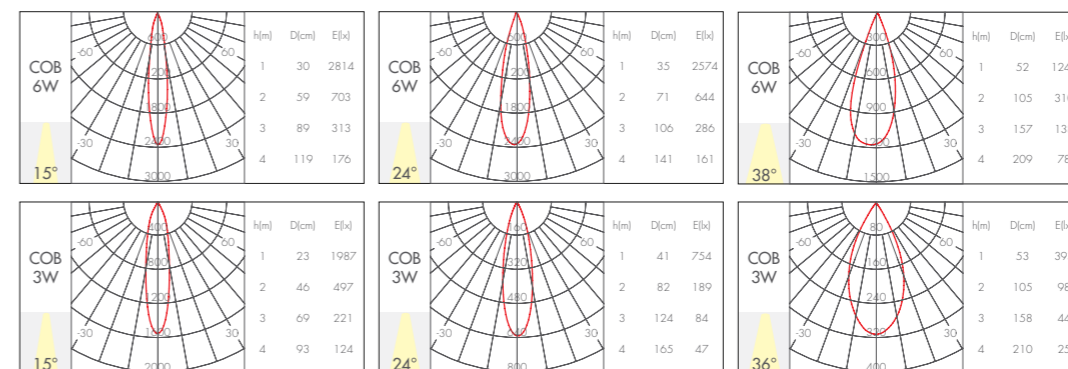

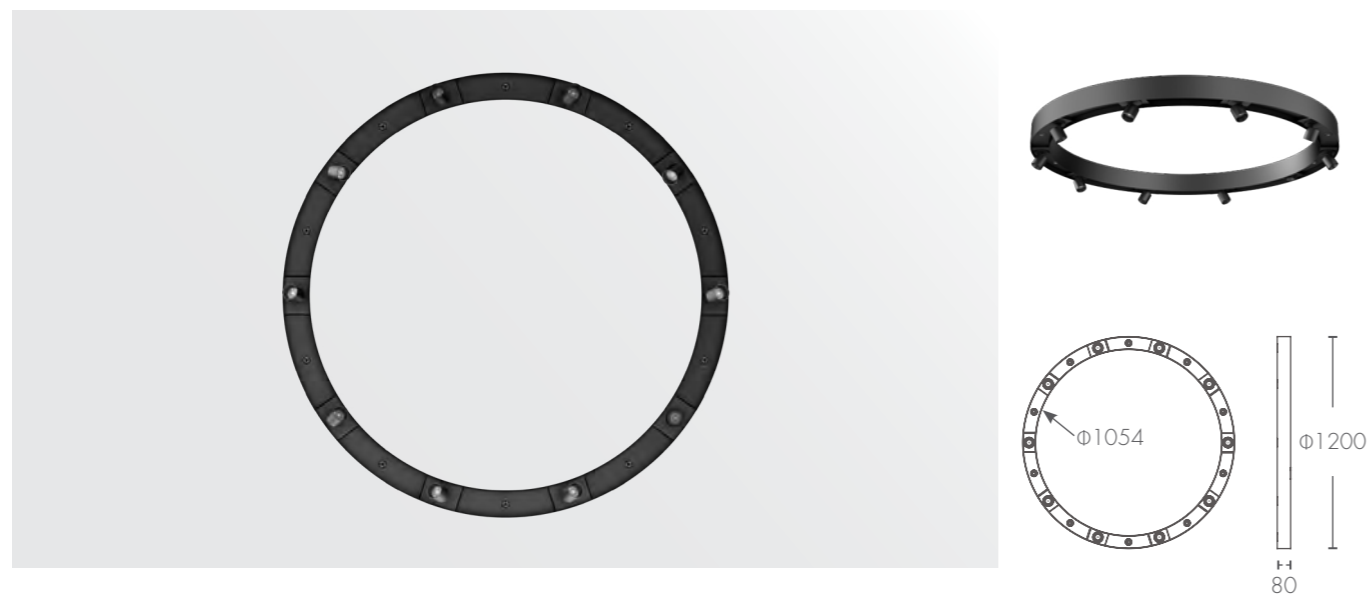
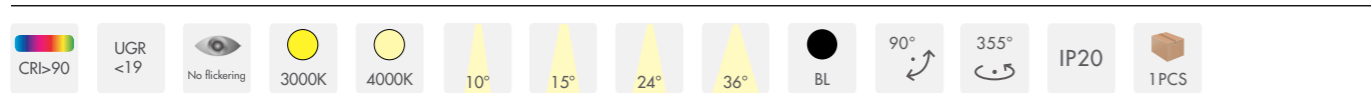

**PRODUCT DATA 产品参数**

Model 型号	Light Source 光源	Power/CCT 功率/色温	Light Output 光通量	Light Efficiency 光效率	Size(DxH) 尺寸	Installation 安装方式
IG-MS6120090	COB/SMD	10x6W+10x3W/3000K	≥10x408 lm+10x155 lm	≥10x69 lm/W+10x52 lm/W	Φ1200x80mm	吊线式 嵌入式 吸顶式

**SINGLE PHOTOMETRIC 单头 6W 配光参数**

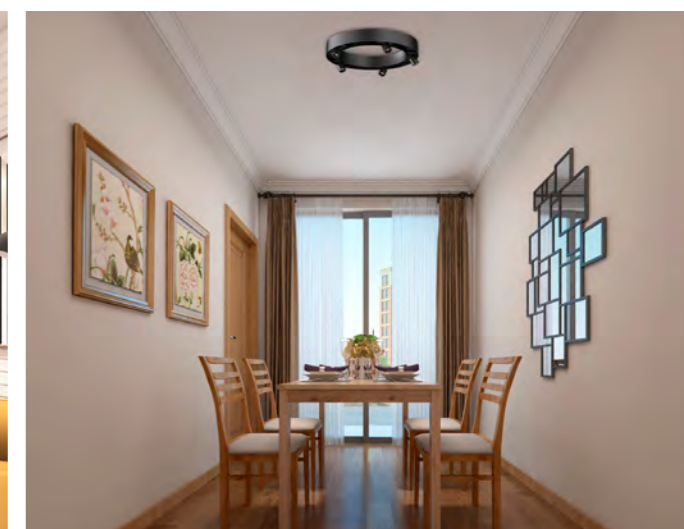
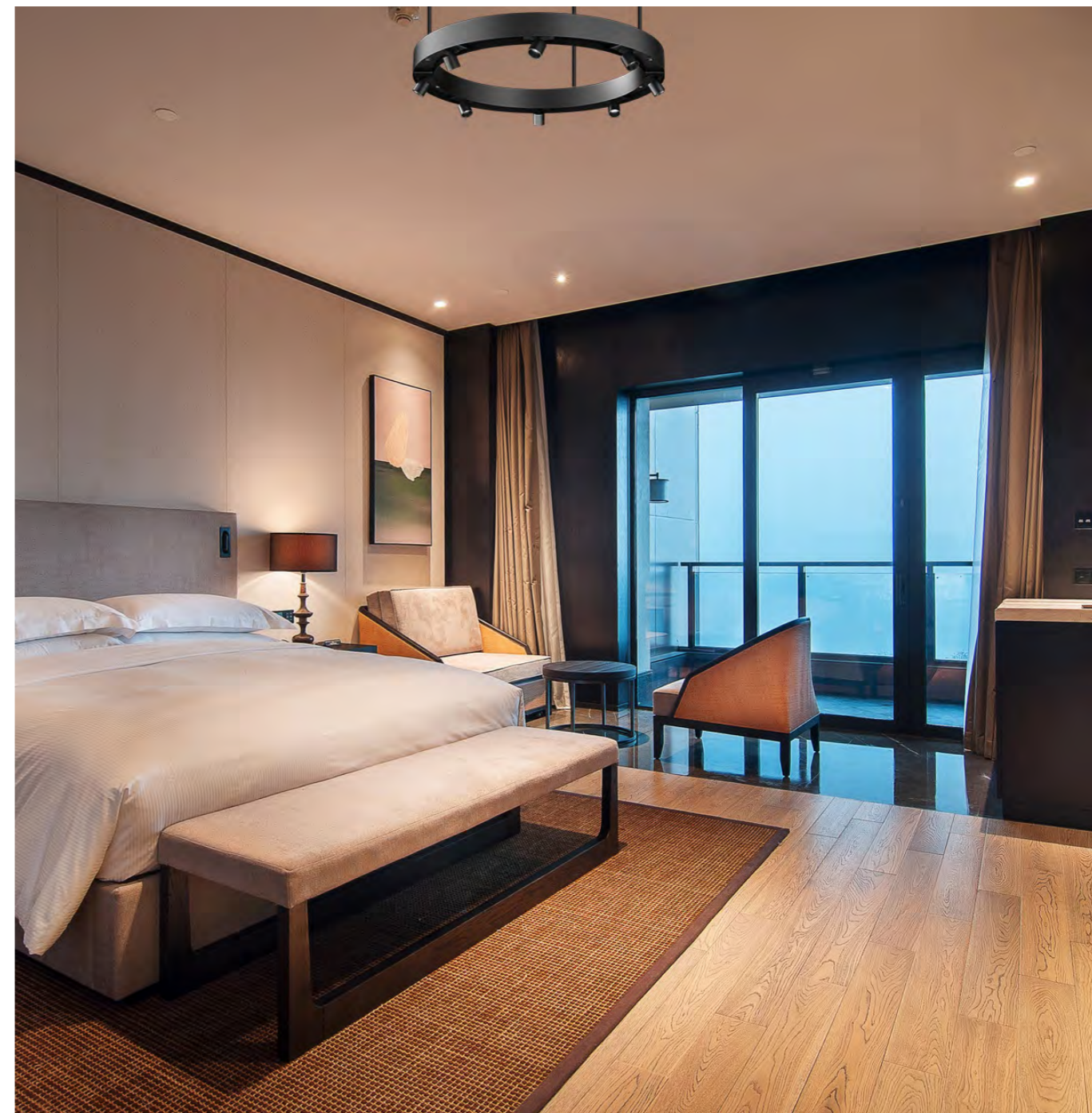
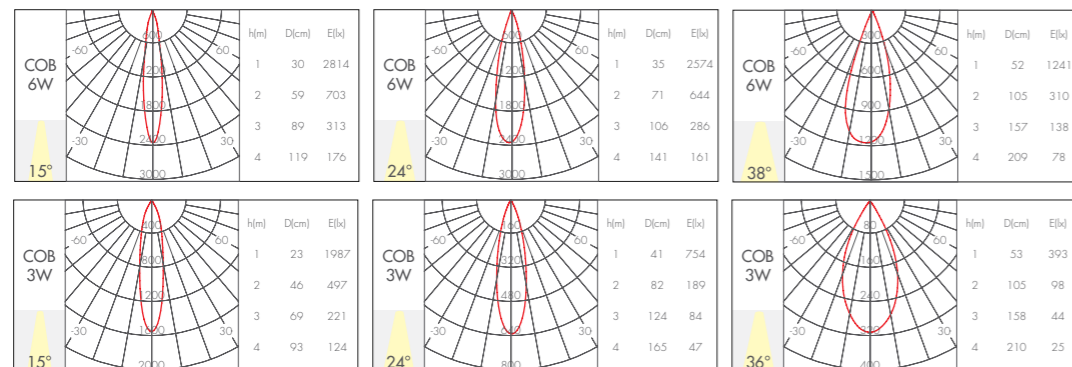

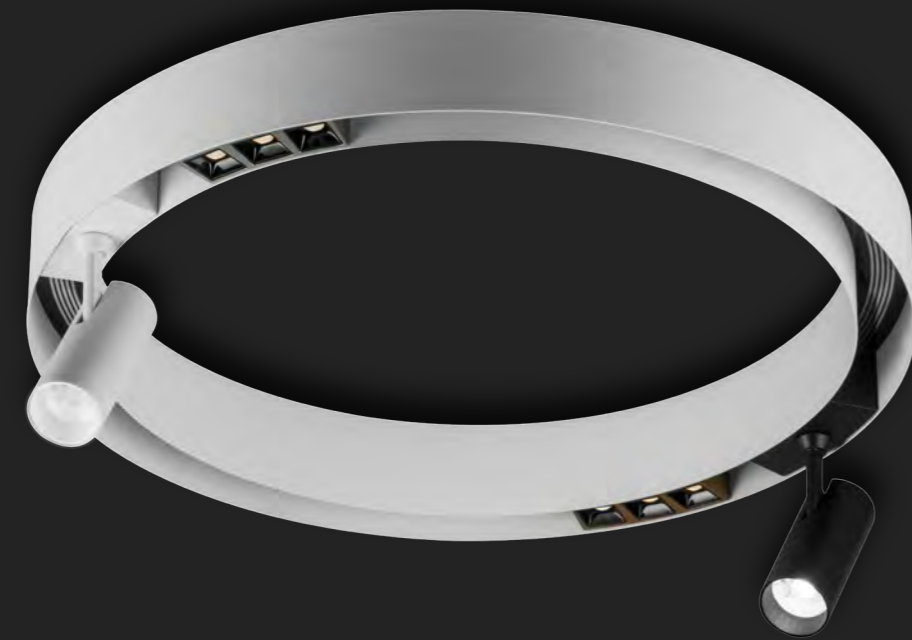
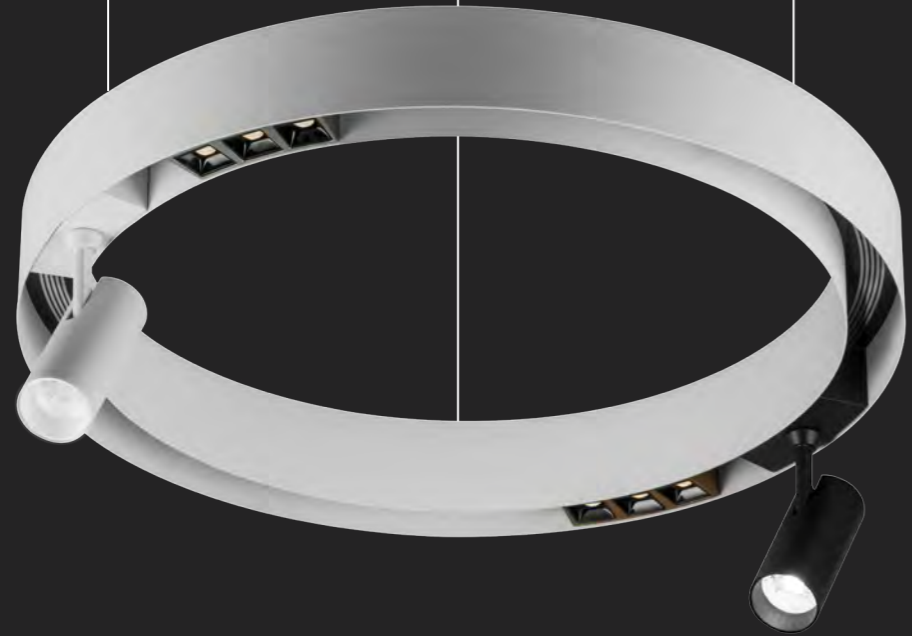

○ WH
● BL
IP20
📦 1PCS



**PRODUCT DATA** 产品参数

Model 型号	Light Source 光源	Power/CCT 功率/色温	Size(DxH) 尺寸	Installation 安装方式
IG-CX660045	/	/	Φ600x75mm	吊线式/吸顶式
IG-CX690072	/	/	Φ900x75mm	吊线式/吸顶式
IG-CX6120090	/	/	Φ1200x75mm	吊线式/吸顶式

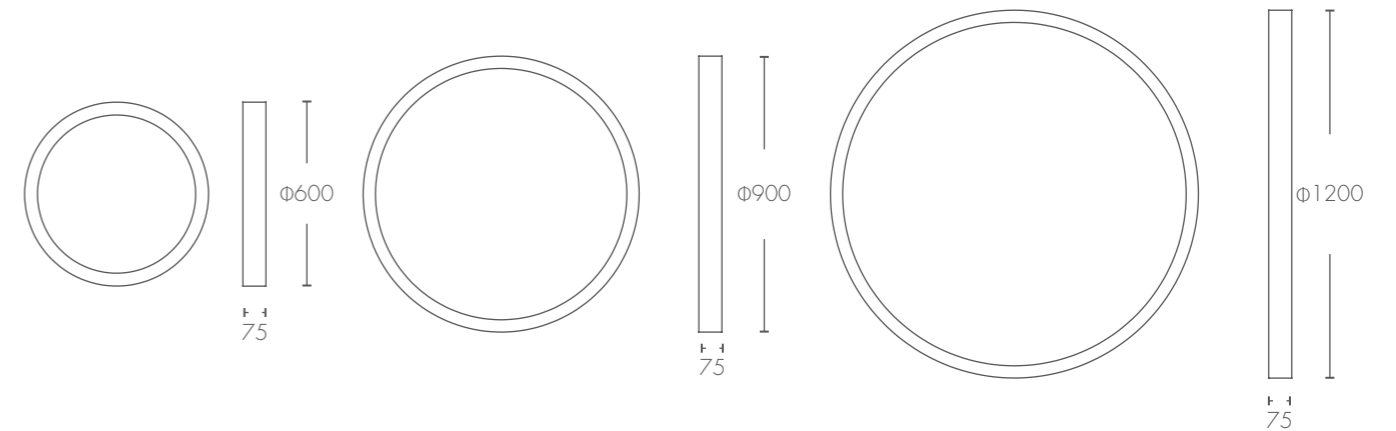

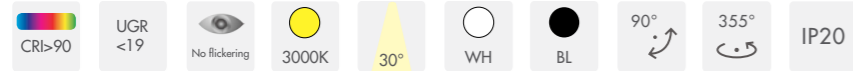

**PRODUCT DATA** 产品参数

Model 型号	Light Source 光源	Power/CCT 功率 / 色温	Size(DxH) 尺寸	Installation 安装方式
IG-CX005007 01	COB	7W/3000K	φ50x128mm	磁吸

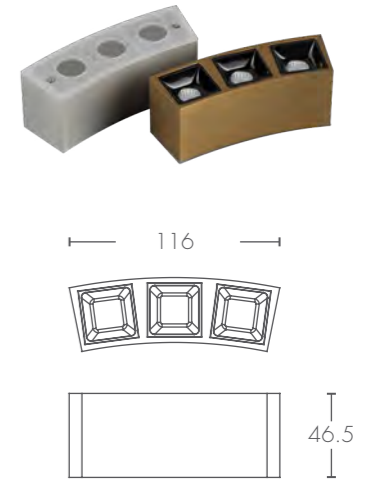

**PRODUCT DATA** 产品参数

Model 型号	Light Source 光源	Power/CCT 功率 / 色温	Size(DxH) 尺寸	Installation 安装方式
IG-CX003504 02	SMD	3.5W/3000K	116x46.5mm	磁吸







#### 市场应用:

店铺、星级酒店、高端别墅、会所、民宿、超市、商业综合体、展览及博物馆等

#### Applications:

Shops, star hotels, high-end villas, clubs, lodging houses, supermarkets, commercial complexes, exhibitions and museums, etc.

#### 产品特性描述:

1. 国际进口品牌光源, CRI > 80/90, 光效高、性能稳定, 光色一致性高;
2. 国标铝材灯体和冷锻散热器, 确保灯具良好外观成型及充分的散热;
3. 优异配光设计并使用国内著名反射器, 光晕自然舒适, 光形好, 峰值光强度高;
4. 内置隔离恒流驱动, 外观简洁、质量稳定;
5. 产品深防眩设计, 防眩角大于 35 度;
6. 系列化产品, 款款经典, 可满足不同场合使用要求;
7. 整灯寿命长达 30000 小时。

#### Product Features:

1. The international import brand light source, CRI > 80/90, has high luminous efficiency, stable performance and high consistency of light and color.
2. High quality aluminum heat sink to ensure ingenious shape and increase heat dissipation space.
3. Excellent precision optical design with high quality reflector, to realise a clear light shape and high peak intensity.
4. High quality isolated constant current driver. Dimming, intelligent control functions for option.
5. Deep anti glare design, anti glare angle greater than 35 degrees.
6. Serialized products, classic design, fit for different applications.
7. Lifespan up to 30,000 hours.

# 拉伸天花灯 STRETCHING

#### 天花灯

Ceiling spotlight

Page. 108



8-12W/15-20W/25-30W/30-35W

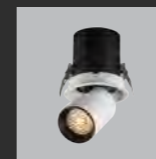

12W



2x12W



3x12W



- CRI > 90
- UGR < 19
- No flickering
- 3000K
- 4000K
- CCT Dimmable
- 15°
- 24°
- 36°
- WH
- IP20
- 45PCS



**PRODUCT DATA** 产品参数

Model 型号	Light Source 光源	Power/CCT 功率 / 色温	Light Output 光通量	Light Efficiency 光效率	Size(DxH) 尺寸	Cutout 开孔尺寸
IG-TH008009	COB	8-12W/3000K	≥480-720 lm	≥60 lm/W	Φ90x106mm	Φ80mm
IG-TH010218	COB	15-20W/3000K	≥900-1200 lm	≥60 lm/W	Φ110x130mm	Φ100mm
IG-TH112025	COB	25-30W/3000K	≥1625-1950 lm	≥65 lm/W	Φ135x160mm	Φ120mm
IG-TH115030	COB	30-35W/3000K	≥1950-2275 lm	≥65 lm/W	Φ165x220mm	Φ155mm

- 可定制  
调光方式:
- 0/1-10v
  - Triac
  - DALI
  - DALI 2
- DALI Dimming

**PHOTOMETRIC** 配光参数

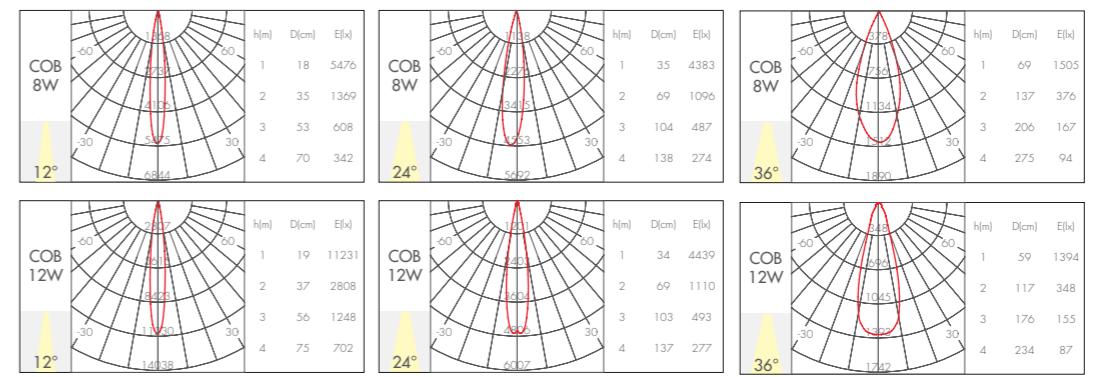



- CRI>90
- UGR <19
- No flickering
- 3000K
- 4000K
- CCT Dimmable
- 12°
- 24°
- 36°
- WH+BL
- 90°
- 360°
- IP20
- 45PCS

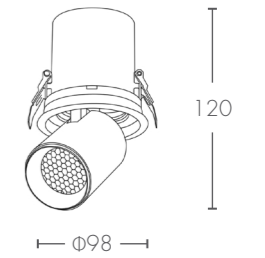
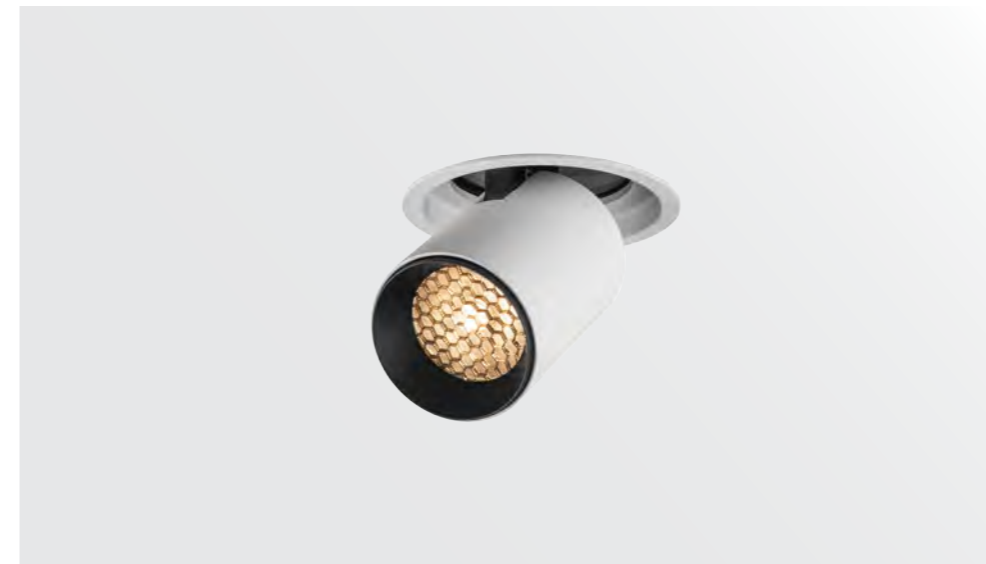

**PRODUCT DATA** 产品参数

Model 型号	Light Source 光源	Power/CCT 功率 / 色温	Light Output 光通量	Light Efficiency 光效率	Size(DxH) 尺寸	Cutout 开孔尺寸
IG-TH009812	COB	12W/3000K	≥590 lm	≥45 lm/W	Φ98x120mm	Φ90mm

- 可定制  
调光方式:
- 0/1-10v
  - Triac
  - DALI
  - DALI 2
- DALI Dimming

**PHOTOMETRIC** 配光参数

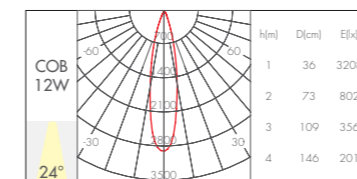

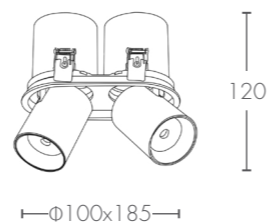
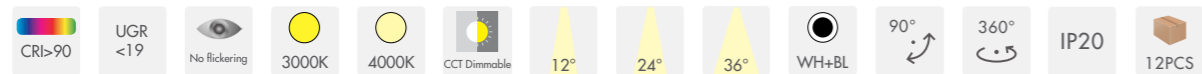

**PRODUCT DATA** 产品参数

Model 型号	Light Source 光源	Power/CCT 功率 / 色温	Light Output 光通量	Light Efficiency 光效率	Size(WxLxH) 尺寸	Cutout 开孔尺寸
IG-TH018524	COB	2x12W/3000K	≥1534 lm	≥64 lm/W	Φ100x185x120mm	175x90mm



**PHOTOMETRIC** 配光参数

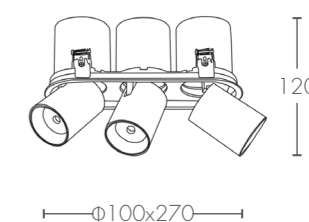
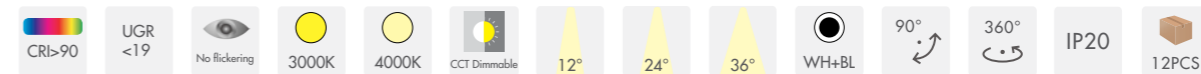
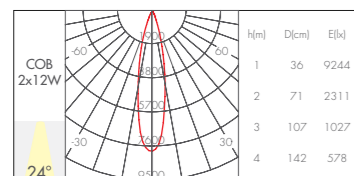

**PRODUCT DATA** 产品参数

Model 型号	Light Source 光源	Power/CCT 功率 / 色温	Light Output 光通量	Light Efficiency 光效率	Size(WxLxH) 尺寸	Cutout 开孔尺寸
IG-TH027036	COB	3x12W/3000K	≥2249 lm	≥63 lm/W	Φ100x270x120mm	260x90mm

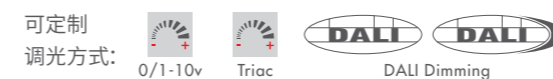

**PHOTOMETRIC** 配光参数

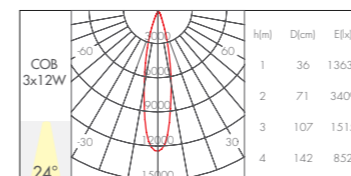



#### 市场应用:

店铺、星级酒店、高端别墅、会所、民宿、超市、商业综合体、展览及博物馆等

#### Applications:

Shops, star hotels, high-end villas, clubs, lodging houses, supermarkets, commercial complexes, exhibitions and museums, etc.

#### 产品特性描述:

1. 国际进口品牌光源, CRI > 80/90, 光效高、性能稳定, 光色一致性高;
2. 国标铝材灯体和冷铜散热器, 确保灯具良好外观成型及充分的散热;
3. 优异配光设计并使用国内著名反射器, 光晕自然舒适, 光形好, 峰值光强度高;
4. 内置隔离恒流驱动, 外观简洁、质量稳定;
5. 产品深防眩设计, 防眩角大于 35 度;
6. 系列化产品, 款款经典, 可满足不同场合使用要求;
7. 整灯寿命长达 30000 小时。

#### Product Features:

1. The international import brand light source, CRI > 80/90, has high luminous efficiency, stable performance and high consistency of light and color.
2. High quality aluminum heat sink to ensure ingenious shape and increase heat dissipation space.
3. Excellent precision optical design with high quality reflector, to realise a clear light shape and high peak intensity.
4. High quality isolated constant current driver. Dimming, intelligent control functions for option.
5. Deep anti glare design, anti glare angle greater than 35 degrees.
6. Serialized products, classic design, fit for different applications.
7. Lifespan up to 30,000 hours.

# 飞马 FUMA

洗墙灯  
Wallwasher



6W

8W/10W/12W

10W/12W  
15W/18W



- CRI > 90
- UGR < 19
- No flickering
- 2700K
- 3000K
- 4000K
- CCT Dimmable
- 15°
- 24°
- 36°
- WH+GY
- 25°
- IP20
- 45PCS

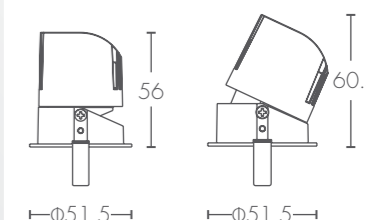

### PRODUCT DATA 产品参数

Model 型号	Light Source 光源	Power/CCT 功率/色温	Light Output 光通量	Light Efficiency 光效率	Size(DxH) 尺寸	Cutout 开孔尺寸
IG-XQ804506 01	COB	6W/3000K	≥350 lm	≥60 lm/W	Φ51.5x56mm	Φ45mm

可定制  
调光方式: 0/1-10v Triac DALI Dimming

### PHOTOMETRIC 配光参数

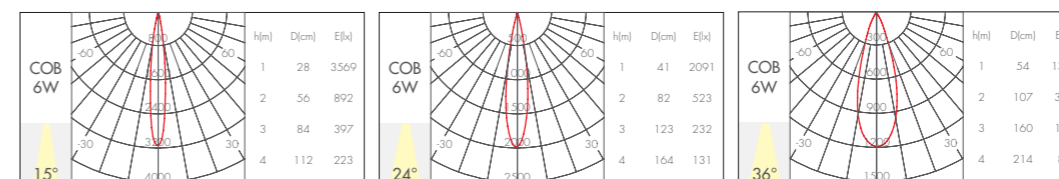

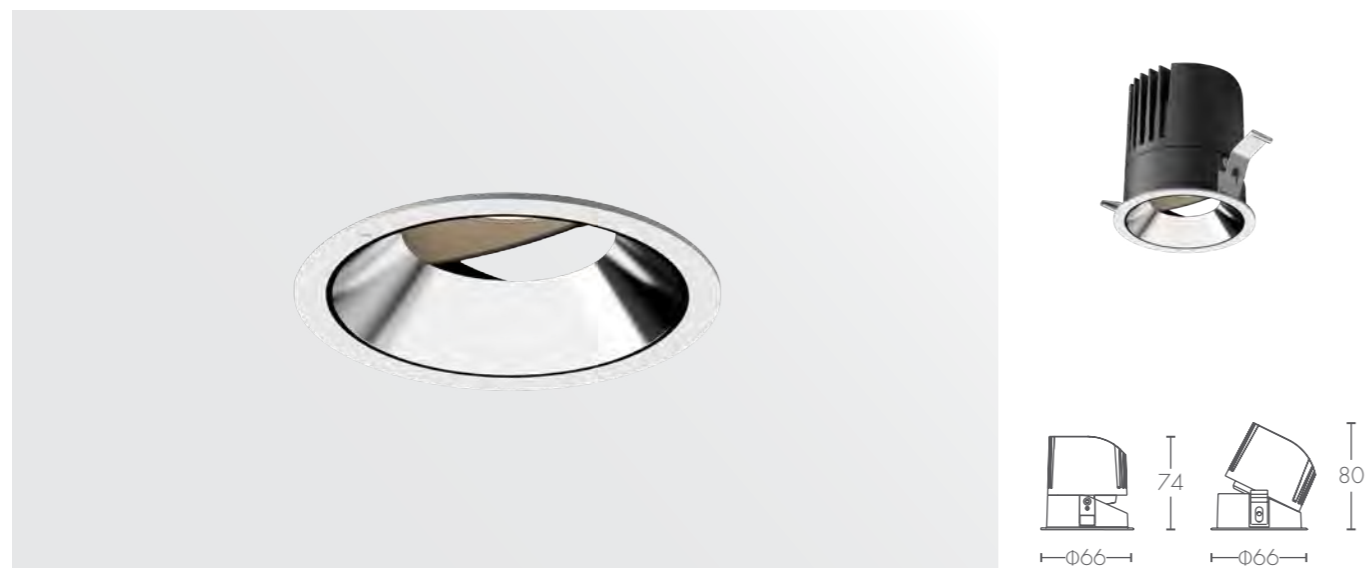

**PRODUCT DATA** 产品参数

Model 型号	Light Source 光源	Power/CCT 功率/色温	Light Output 光通量	Light Efficiency 光效率	Size(DxH) 尺寸	Cutout 开孔尺寸
IG-XQ806008	COB	8W/3000K	≥520 lm	≥65 lm/W	Φ66x74mm	Φ60mm
IG-XQ806010	COB	10W/3000K	≥650 lm	≥65 lm/W	Φ66x74mm	Φ60mm
IG-XQ806012	COB	12W/3000K	≥780 lm	≥65 lm/W	Φ66x74mm	Φ60mm



**PHOTOMETRIC** 配光参数

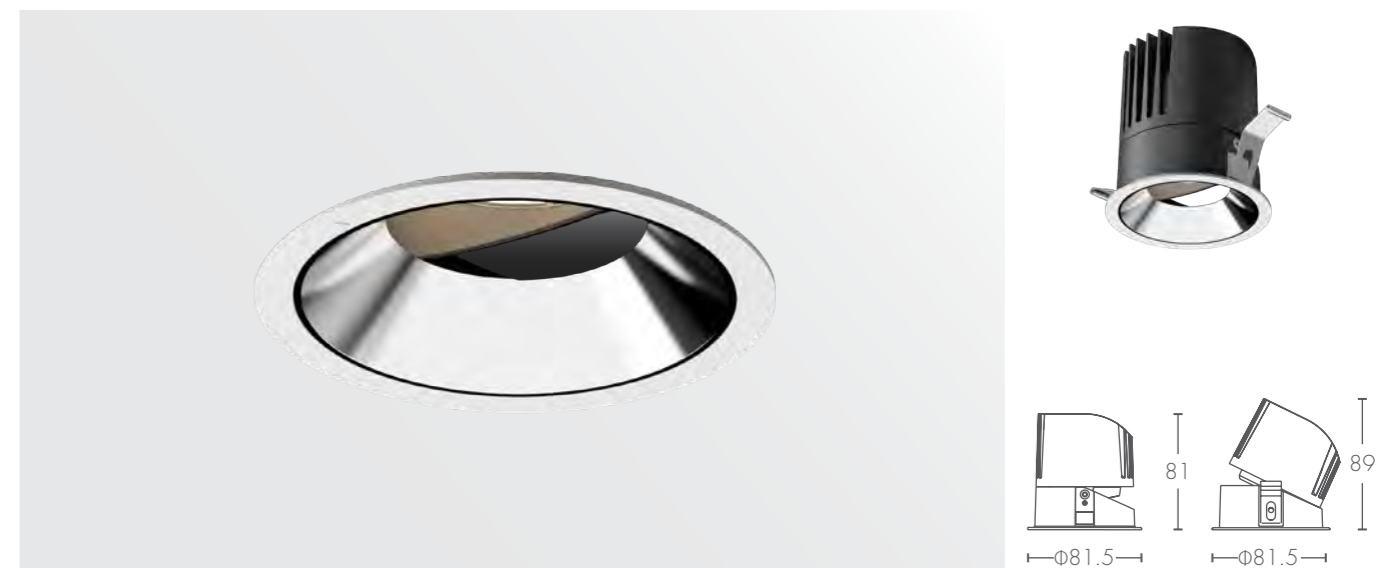
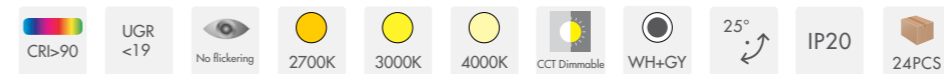
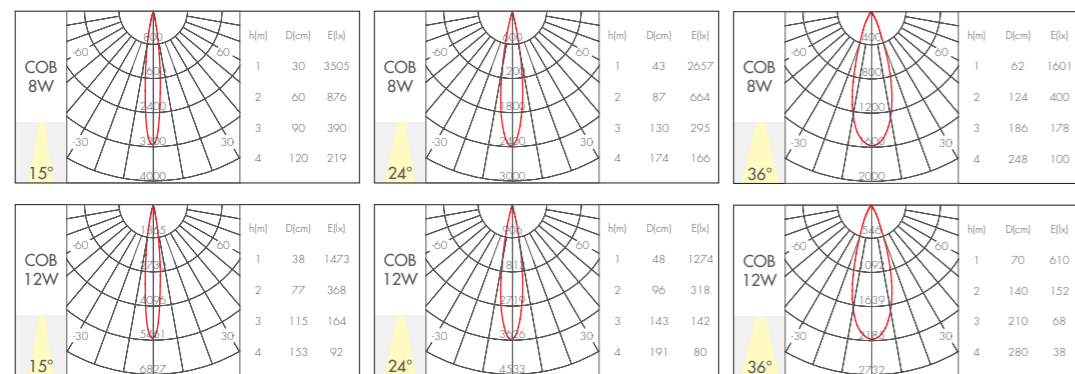

**PRODUCT DATA** 产品参数

Model 型号	Power/CCT 功率/色温	Light Output 光通量	Light Efficiency 光效率	Beam angle 光束角	Cutout 开孔尺寸
IG-XQ807510	10W/3000K	≥500 lm	≥50 lm/W	4°	Φ75mm
IG-XQ807512	12W/3000K	≥780 lm	≥65 lm/W	12°/15°/24°/36°	Φ75mm
IG-XQ807515	15W/3000K	≥975 lm	≥65 lm/W	15°/24°/36°	Φ75mm
IG-XQ807518	* 18W/3000K	≥1170 lm	≥65 lm/W	15°/24°/36°	Φ75mm



**PHOTOMETRIC** 配光参数

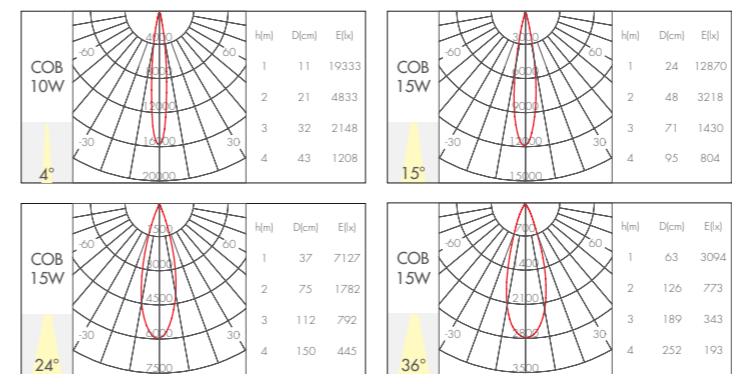





#### 市场应用:

店铺、星级酒店、高端别墅、会所、民宿、超市、商业综合体、展览及博物馆等

#### Applications:

Shops, star hotels, high-end villas, clubs, lodging houses, supermarkets, commercial complexes, exhibitions and museums, etc.

#### 产品特性描述:

1. 国际进口品牌光源, CRI > 80/90, 光效高、性能稳定, 光色一致性高;
2. 国标铝材灯体和冷银散热器, 确保灯具良好外观成型及充分的散热;
3. 优异配光设计并使用国内著名反射器, 光晕自然舒适, 光形好, 峰值光强度高;
4. 内置隔离恒流驱动, 外观简洁、质量稳定;
5. 产品深防眩设计, 防眩角大于 35 度;
6. 系列化产品, 款款经典, 可满足不同场合使用要求;
7. 整灯寿命长达 30000 小时。

#### Product Features:

1. The international import brand light source, CRI > 80/90, has high luminous efficiency, stable performance and high consistency of light and color.
2. High quality aluminum heat sink to ensure ingenious shape and increase heat dissipation space.
3. Excellent precision optical design with high quality reflector, to realise a clear light shape and high peak intensity.
4. High quality isolated constant current driver. Dimming, intelligent control functions for option.
5. Deep anti glare design, anti glare angle greater than 35 degrees.
6. Serialized products, classic design, fit for different applications.
7. Lifespan up to 30,000 hours.

# 风华 FENGHUA

## 天花灯 Ceiling spotlight

Page. 122

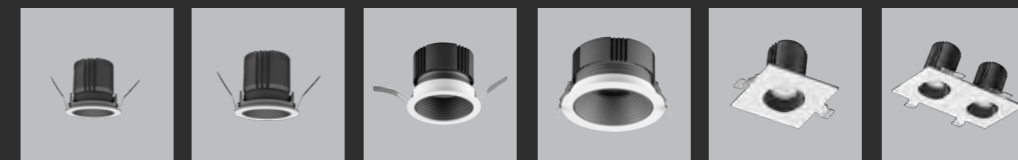

8W

8W/12W

15W/20W/25W

30W/35W

15W

2x15W

## 明装筒灯 Surface mounted downlight

Page. 129



15W

15W

## 洗墙灯 Wallwasher

Page. 132

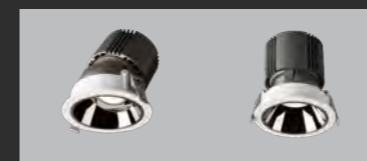

12W/15W/20W/25W



- CRI > 90
- UGR < 16
- No flickering
- 2700K
- 3000K
- 4000K
- CCT Dimmable
- 15°
- 24°
- 36°
- WH+GY
- 25°
- IP20
- 45PCS

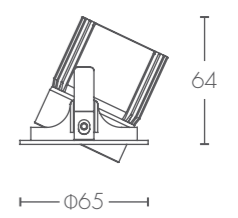

**PRODUCT DATA** 产品参数

Model 型号	Light Source 光源	Power/CCT 功率/色温	Light Output 光通量	Light Efficiency 光效率	Size(DxH) 尺寸	Cutout 开孔尺寸
IG-TH306008 01	COB	8W/3000K	≥600 lm	≥75 lm/W	Φ65x64mm	Φ60mm

- 可定制  
调光方式:
- 0/1-10v
  - Triac
  - DALI Dimming

**PHOTOMETRIC** 配光参数

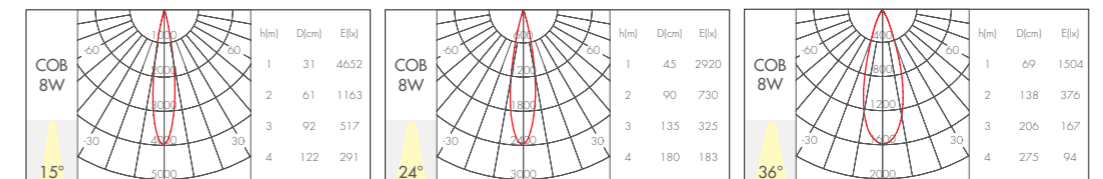

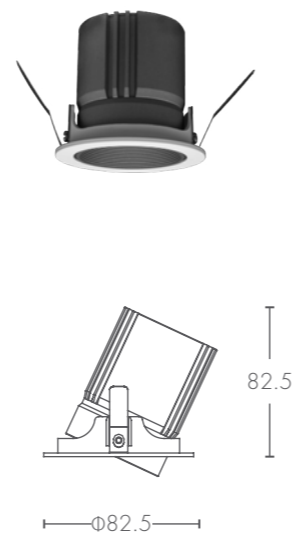
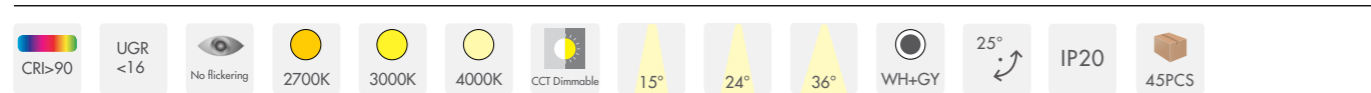

**PRODUCT DATA** 产品参数

Model 型号	Light Source 光源	Power/CCT 功率 / 色温	Light Output 光通量	Light Efficiency 光效率	Size(DxH) 尺寸	Cutout 开孔尺寸
IG-TH307508 01	COB	8W/3000K	≥560 lm	≥70 lm/W	Φ82.5x82.5mm	Φ75mm
IG-TH307512 01	COB	12W/3000K	≥840 lm	≥70 lm/W	Φ82.5x82.5mm	Φ75mm



**PHOTOMETRIC** 配光参数

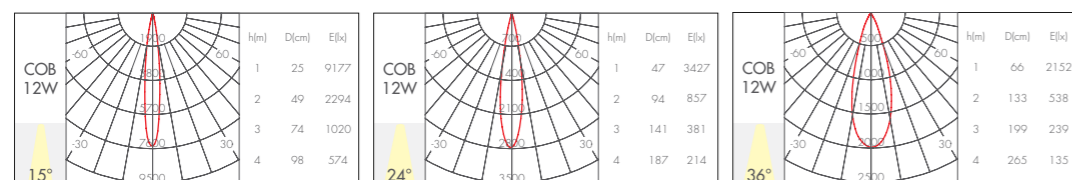



**PRODUCT DATA** 产品参数

Model 型号	Light Source 光源	Power/CCT 功率 / 色温	Light Output 光通量	Light Efficiency 光效率	Size(DxH) 尺寸	Cutout 开孔尺寸
IG-TH309515 01	COB	15W/3000K	≥1000 lm	≥66 lm/W	Φ101x95.5mm	Φ95mm
IG-TH309520 01	COB	20W/3000K	≥1400 lm	≥70 lm/W	Φ101x95.5mm	Φ95mm
IG-TH309525 01	COB	25W/3000K	≥1650 lm	≥66 lm/W	Φ101x95.5mm	Φ95mm



**PHOTOMETRIC** 配光参数

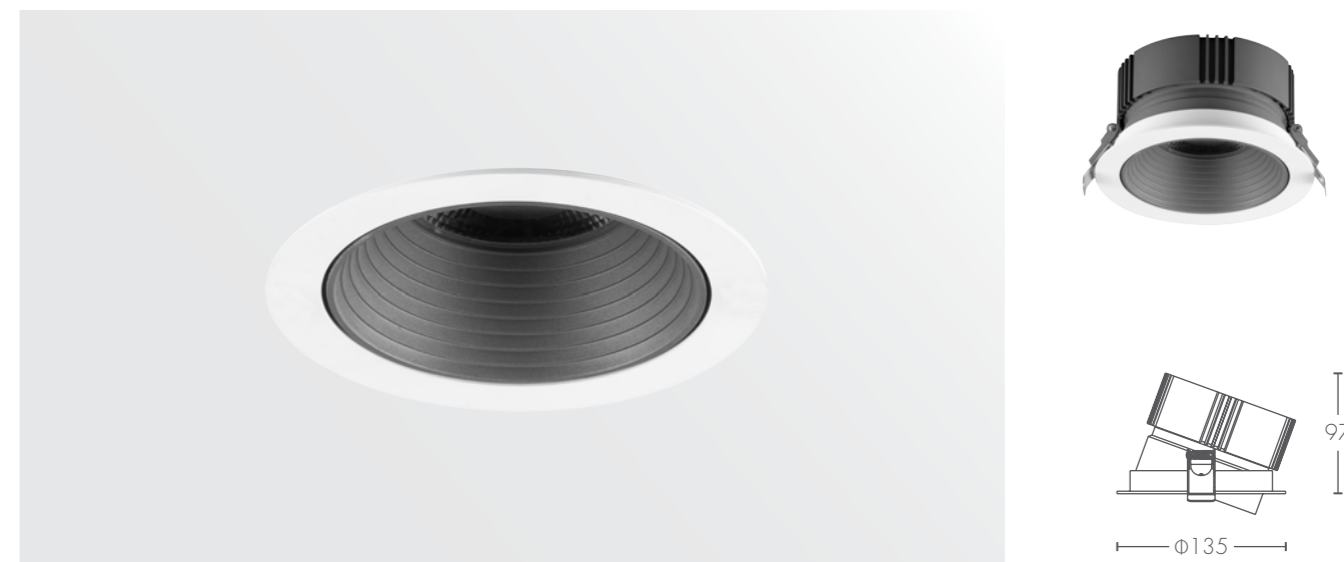
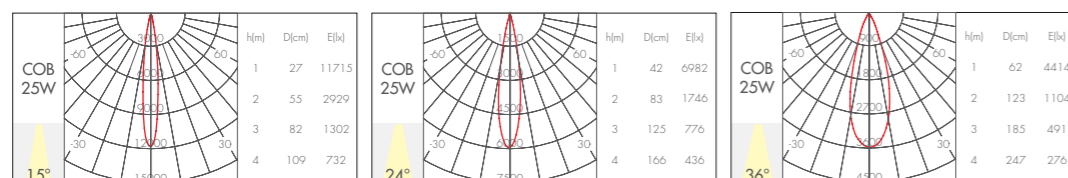

**PRODUCT DATA** 产品参数

Model 型号	Light Source 光源	Power/CCT 功率 / 色温	Light Output 光通量	Light Efficiency 光效率	Size(DxH) 尺寸	Cutout 开孔尺寸
IG-TH312530 01	COB	30W/3000K	≥1800 lm	≥60 lm/W	Φ135x97mm	Φ125mm
IG-TH312535 01	COB	35W/3000K	≥1900 lm	≥55 lm/W	Φ135x97mm	Φ125mm

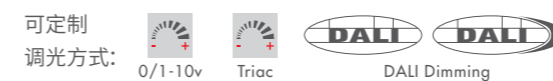

**PHOTOMETRIC** 配光参数

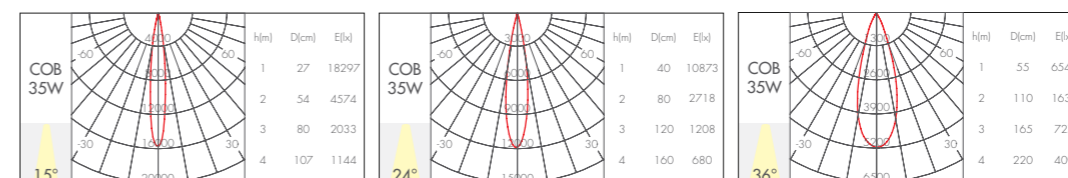

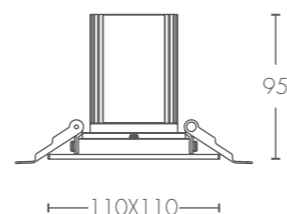
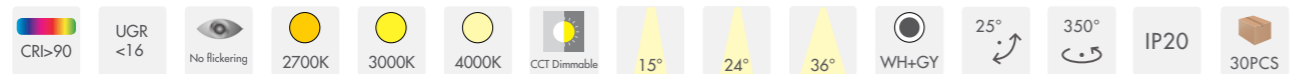

**PRODUCT DATA** 产品参数

Model 型号	Light Source 光源	Power/CCT 功率/色温	Light Output 光通量	Light Efficiency 光效率	Size(WxLxH) 尺寸	Cutout 开孔尺寸
IG-GS308015 01	COB	15W/3000K	≥975 lm	≥65 lm/W	110x110x95mm	∅80mm



**PHOTOMETRIC** 配光参数

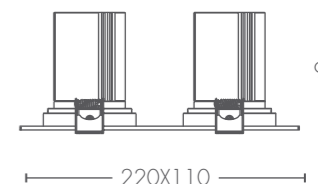
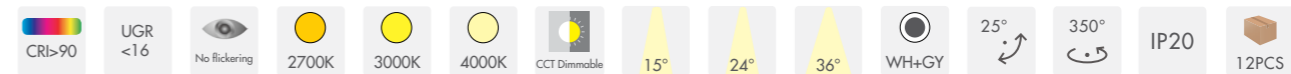
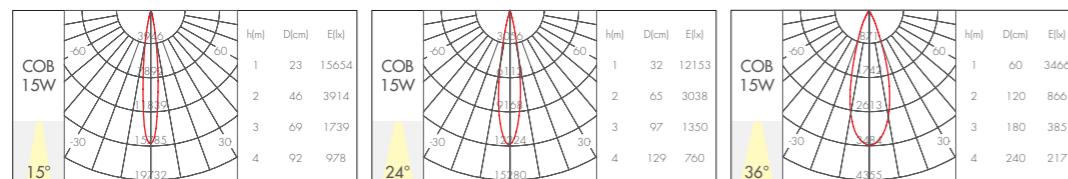

**PRODUCT DATA** 产品参数

Model 型号	Light Source 光源	Power/CCT 功率/色温	Light Output 光通量	Light Efficiency 光效率	Size(WxLxH) 尺寸	Cutout 开孔尺寸
IG-GS316015 01	COB	2x15W/3000K	≥1950 lm	≥65 lm/W	220x110x95mm	190x80mm



**PHOTOMETRIC** 配光参数

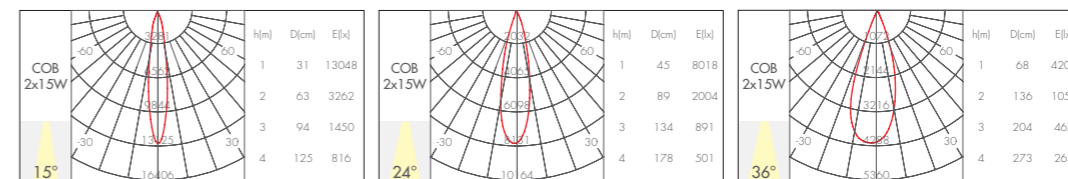



**PRODUCT DATA** 产品参数

Model 型号	Light Source 光源	Power/CCT 功率/色温	Light Output 光通量	Light Efficiency 光效率	Size(WxLxH) 尺寸	Installation 安装方式
IG-MS310015 01	COB	15W/3000K	≥975 lm	≥65 lm/W	Φ100x155mm	吸顶式



**PHOTOMETRIC** 配光参数

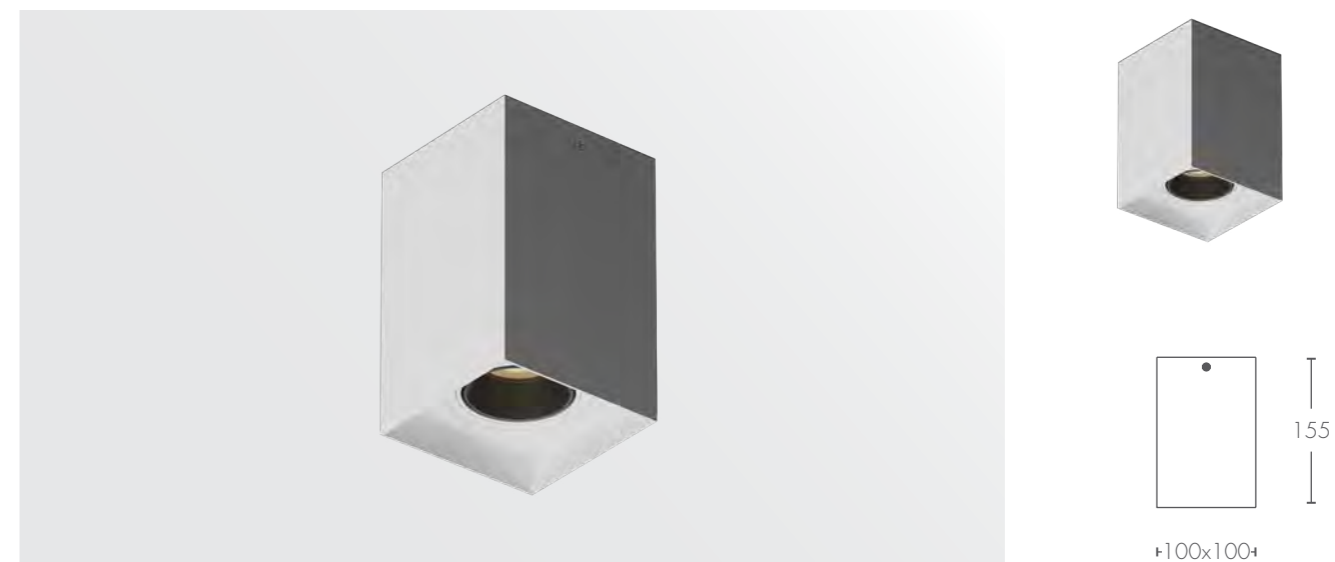
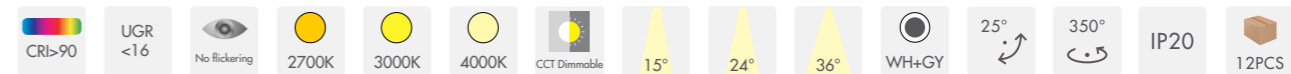
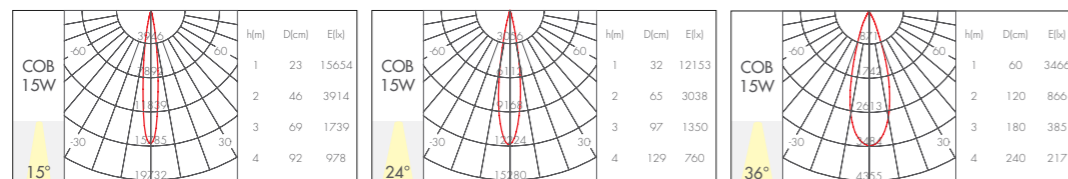

**PRODUCT DATA** 产品参数

Model 型号	Light Source 光源	Power/CCT 功率/色温	Light Output 光通量	Light Efficiency 光效率	Size(WxLxH) 尺寸	Installation 安装方式
IG-MS310015 02	COB	15W/3000K	≥975 lm	≥65 lm/W	100x100x155mm	吸顶式



**PHOTOMETRIC** 配光参数

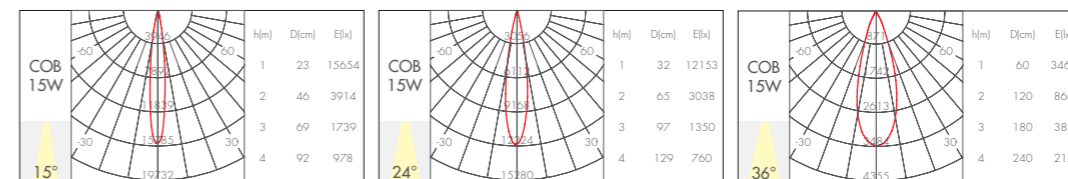



CRI>95
UGR <16
No flickering
2700K
3000K
CCT Dimmable
15°
24°
38°
60°
WH+GR
BL\*
30°
350°
IP20
12PCS

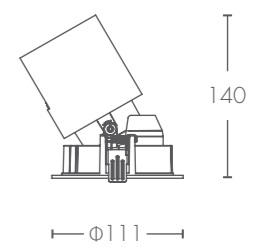

**PRODUCT DATA** 产品参数

Model 型号	Light Source 光源	Power/CCT 功率 / 色温	Light Output 光通量	Light Efficiency 光效率	Size(DxH) 尺寸	Cutout 开孔尺寸
IG-XQ309512 01	COB	12W/3000K	≥660 lm	≥55 lm/W	Φ111x140mm	Φ95mm
IG-XQ309515 01	COB	15W/3000K	≥990 lm	≥55 lm/W	Φ111x140mm	Φ95mm
IG-XQ309520 01	COB	20W/3000K	≥1100 lm	≥55 lm/W	Φ111x140mm	Φ95mm
IG-XQ309525 01	COB	25W/3000K	≥1375 lm	≥55 lm/W	Φ111x140mm	Φ95mm

可定制  
 调光方式: 0/1-10v Triac DALI Dimming

**PHOTOMETRIC** 配光参数

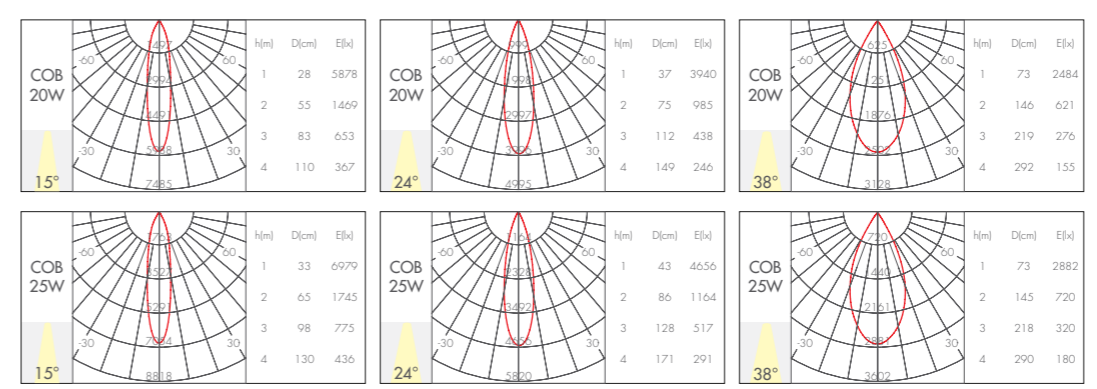

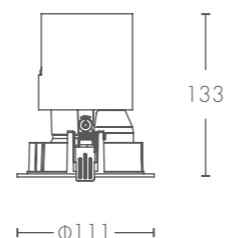
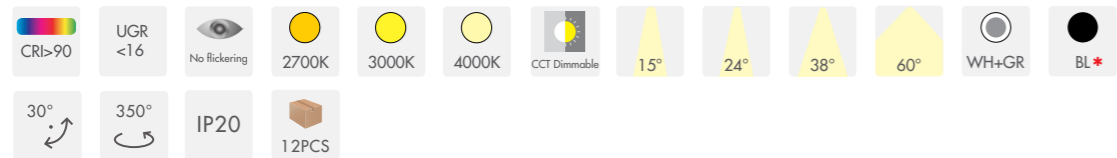

**PRODUCT DATA** 产品参数

Model 型号	Light Source 光源	Power/CCT 功率/色温	Light Output 光通量	Light Efficiency 光效率	Size(DxH) 尺寸	Cutout 开孔尺寸
IG-XQ309512 02	COB	12W/3000K	≥720 lm	≥60 lm/W	Φ111x133mm	Φ95mm
IG-XQ309515 02	COB	15W/3000K	≥900 lm	≥60 lm/W	Φ111x133mm	Φ95mm
IG-XQ309520 02	COB	20W/3000K	≥1200 lm	≥60 lm/W	Φ111x133mm	Φ95mm
IG-XQ309525 02	COB	25W/3000K	≥1500 lm	≥60 lm/W	Φ111x133mm	Φ95mm



**PHOTOMETRIC** 配光参数

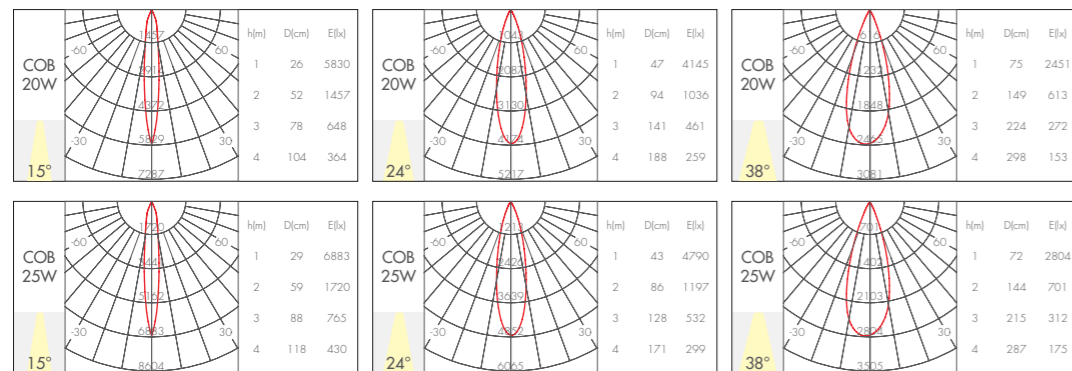





#### 市场应用:

店铺、星级酒店、高端别墅、会所、民宿、超市、商业综合体、展览及博物馆等

#### Applications:

Shops, star hotels, high-end villas, clubs, lodging houses, supermarkets, commercial complexes, exhibitions and museums, etc.

#### 产品特性描述:

1. 国际进口品牌光源, CRI > 80/90, 光效高、性能稳定, 光色一致性高;
2. 国标铝材灯体和冷锻散热器, 确保灯具良好外观成型及充分的散热;
3. 优异配光设计并使用国内著名反射器, 光晕自然舒适, 光形好, 峰值光强度高;
4. 内置隔离恒流驱动, 外观简洁、质量稳定;
5. 产品深防眩设计, 防眩角大于 35 度;
6. 系列化产品, 款款经典, 可满足不同场合使用要求;
7. 整灯寿命长达 30000 小时。

#### Product Features:

1. The international import brand light source, CRI > 80/90, has high luminous efficiency, stable performance and high consistency of light and color.
2. High quality aluminum heat sink to ensure ingenious shape and increase heat dissipation space.
3. Excellent precision optical design with high quality reflector, to realise a clear light shape and high peak intensity.
4. High quality isolated constant current driver. Dimming, intelligent control functions for option.
5. Deep anti glare design, anti glare angle greater than 35 degrees.
6. Serialized products, classic design, fit for different applications.
7. Lifespan up to 30,000 hours.

# 飞凌 FUNLINE

#### 格栅灯

Grille spotlight



8W 8W 8W 8W 8W 8W



2x8W 2x8W 2x8W 2x8W 2x8W 2x8W



8W 8W 8W 8W 8W 8W

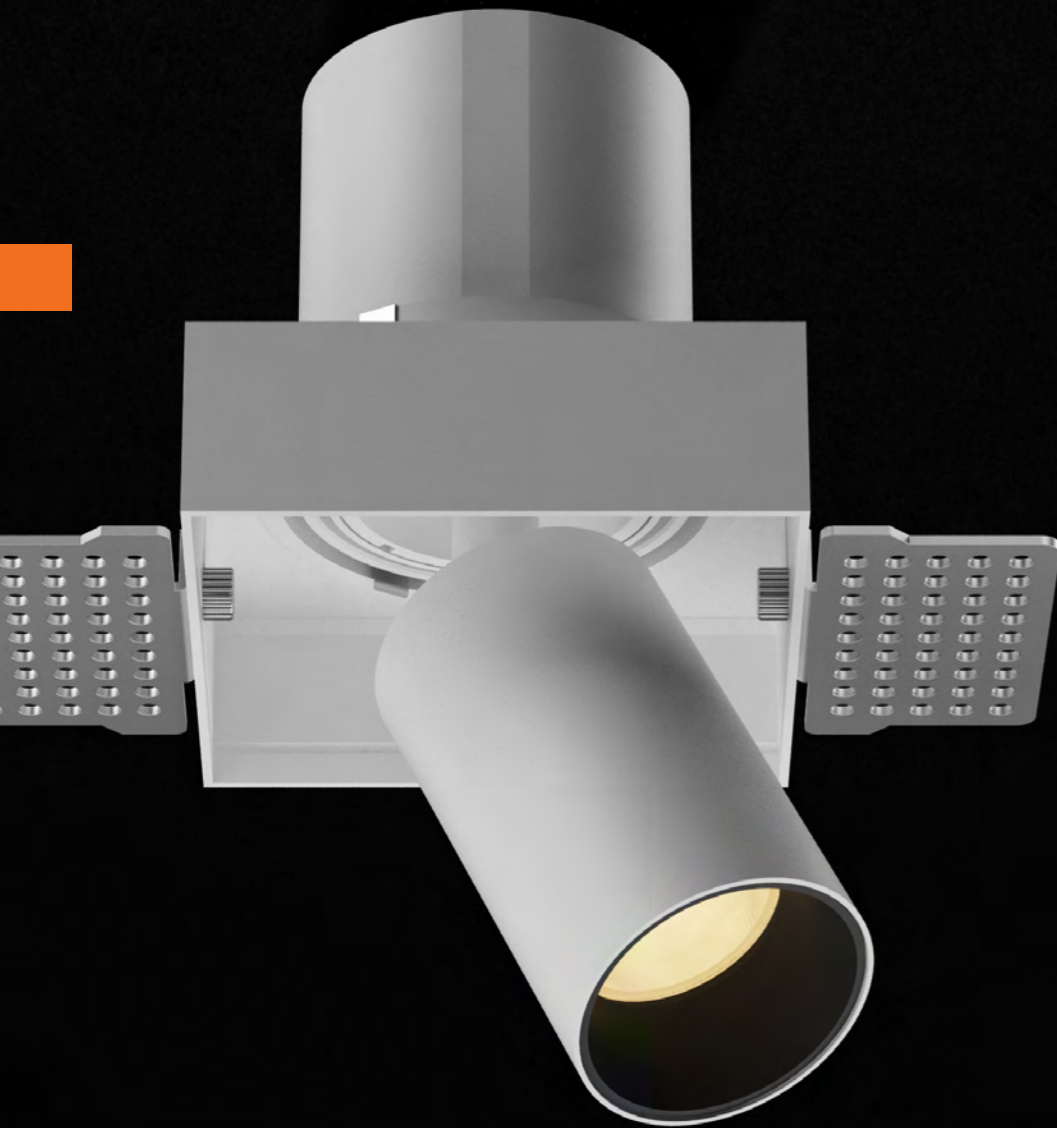

- CRI>90
- UGR <16
- No flickering
- 2700K
- 3000K
- 4000K
- CCT Dimmable
- 15°
- 24°
- 36°
- WH
- BL
- 40°
- 350°
- IP20

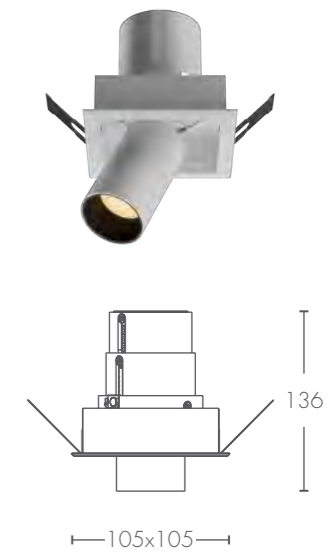

**PRODUCT DATA** 产品参数

Model 型号	Light Source 光源	Power/CCT 功率/色温	Light Output 光通量	Light Efficiency 光效率	Size(WxLxH) 尺寸	Cutout 开孔尺寸
IG-GS909508 01W	COB	8W/3000K	≥552 lm	≥69 lm/W	105x105x136mm	95x95mm

可定制  
调光方式: 0/1-10v Triac DALI DALI 2  
DALI Dimming

**PHOTOMETRIC** 配光参数

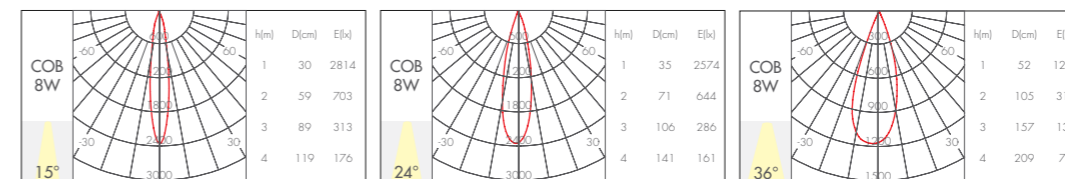

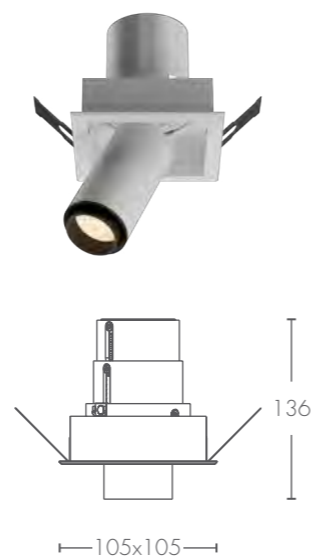

**PRODUCT DATA** 产品参数

Model 型号	Light Source 光源	Power/CCT 功率 / 色温	Light Output 光通量	Light Efficiency 光效率	Size(WxLxH) 尺寸	Cutout 开孔尺寸
IG-GS909508T 01W	COB	8W/3000K	≥520 lm	≥65 lm/W	105x105x136mm	95x95mm

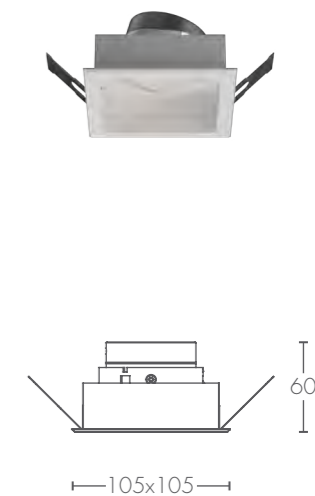
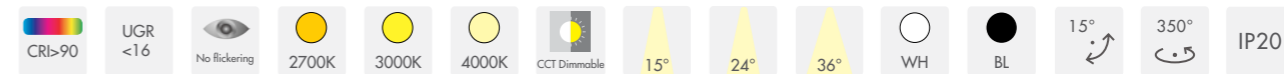

**PRODUCT DATA** 产品参数

Model 型号	Light Source 光源	Power/CCT 功率 / 色温	Light Output 光通量	Light Efficiency 光效率	Size(WxLxH) 尺寸	Cutout 开孔尺寸
IG-GS909508M 01W	COB	8W/3000K	≥550 lm	≥68 lm/W	105x105x60mm	95x95mm



**PHOTOMETRIC** 配光参数

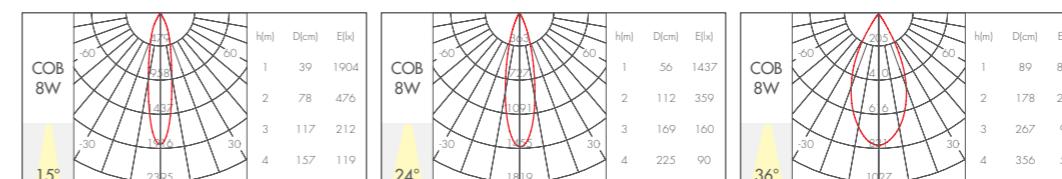

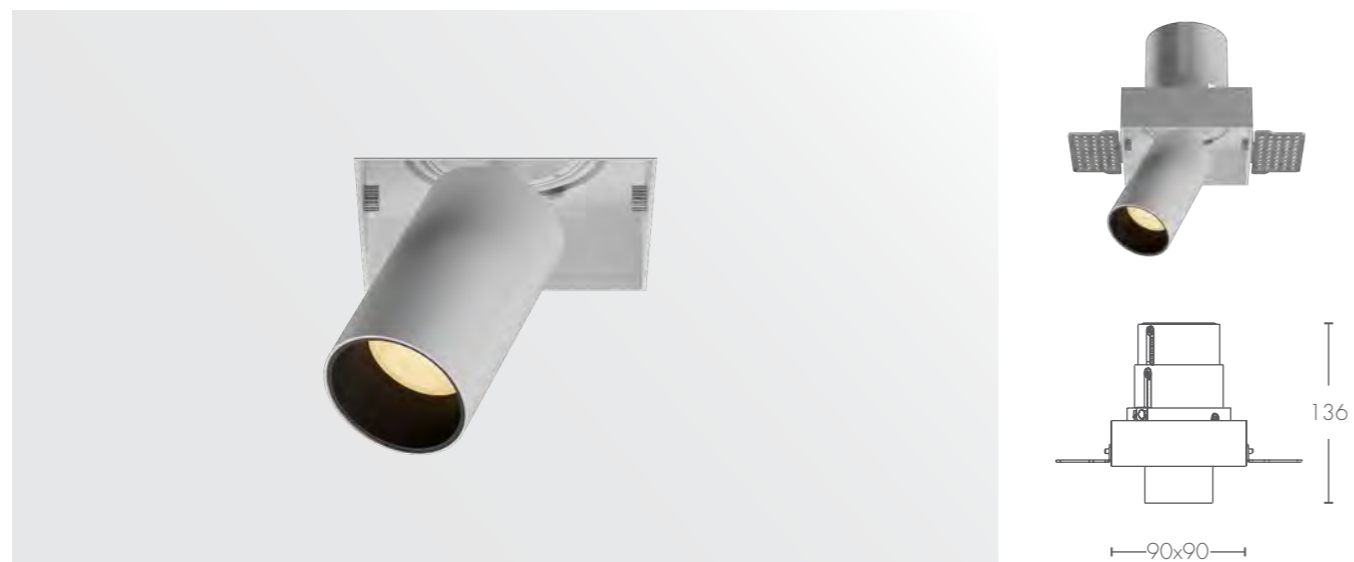

**PRODUCT DATA** 产品参数

Model 型号	Light Source 光源	Power/CCT 功率/色温	Light Output 光通量	Light Efficiency 光效率	Size(WxLxH) 尺寸	Cutout 开孔尺寸
IG-GS909508 02W	COB	8W/3000K	≥552 lm	≥69 lm/W	90x90x136mm	90x90mm



**PHOTOMETRIC** 配光参数

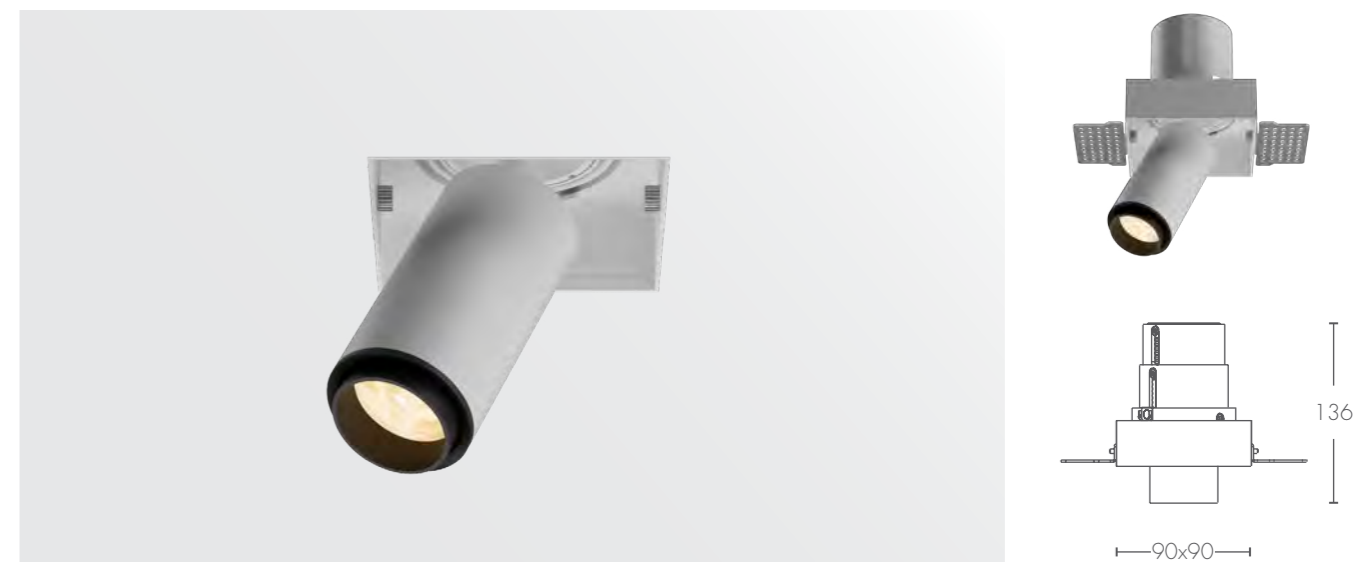
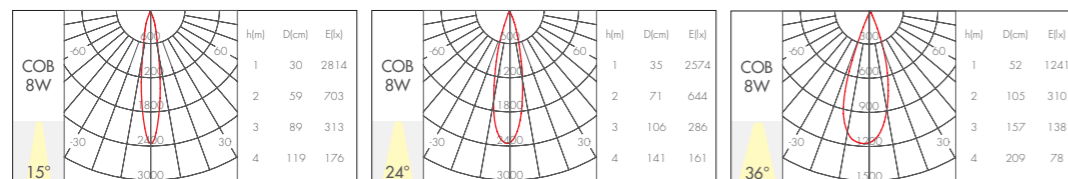

**PRODUCT DATA** 产品参数

Model 型号	Light Source 光源	Power/CCT 功率/色温	Light Output 光通量	Light Efficiency 光效率	Size(WxLxH) 尺寸	Cutout 开孔尺寸
IG-GS909508T 02W	COB	8W/3000K	≥520 lm	≥65 lm/W	90x90x136mm	90x90mm



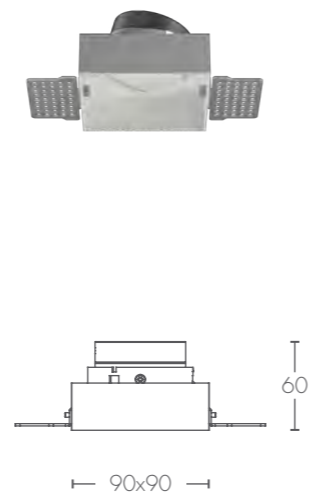
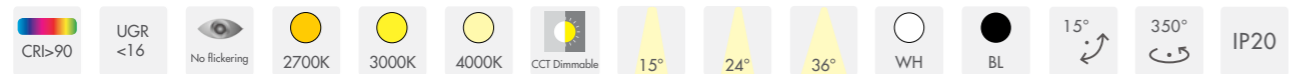

**PRODUCT DATA** 产品参数

Model 型号	Light Source 光源	Power/CCT 功率/色温	Light Output 光通量	Light Efficiency 光效率	Size(WxLxH) 尺寸	Cutout 开孔尺寸
IG-GS909508M 02W	COB	8W/3000K	≥550 lm	≥68 lm/W	90x90x60mm	90x90mm



**PHOTOMETRIC** 配光参数

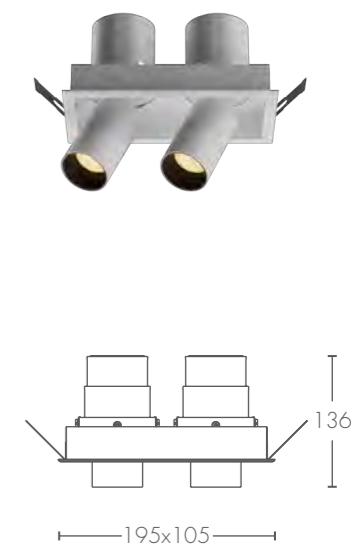
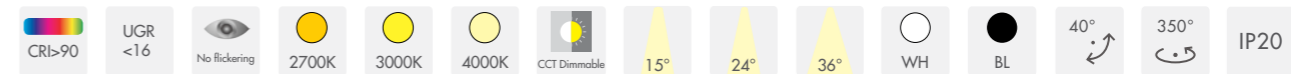
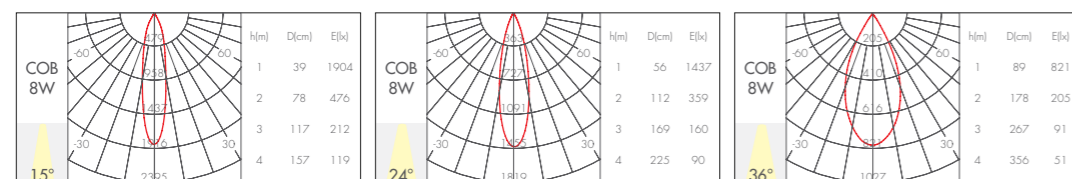

**PRODUCT DATA** 产品参数

Model 型号	Light Source 光源	Power/CCT 功率/色温	Light Output 光通量	Light Efficiency 光效率	Size(WxLxH) 尺寸	Cutout 开孔尺寸
IG-GS918516 01W	COB	2x8W/3000K	≥2x552 lm	≥2x69 lm/W	195x105x136mm	185x95mm



**PHOTOMETRIC** 配光参数

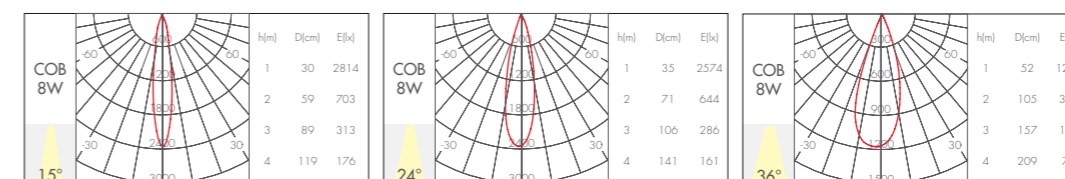

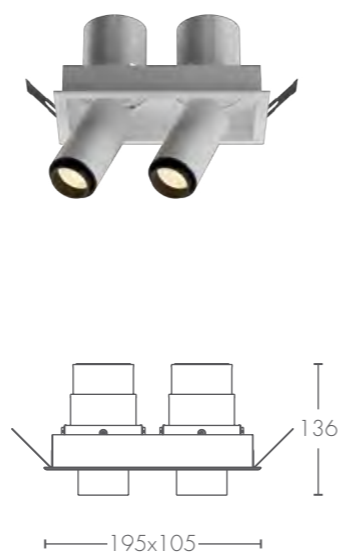

**PRODUCT DATA** 产品参数

Model 型号	Light Source 光源	Power/CCT 功率 / 色温	Light Output 光通量	Light Efficiency 光效率	Size(WxLxH) 尺寸	Cutout 开孔尺寸
IG-GS918516T 01W	COB	2x8W/3000K	≥2x520 lm	≥2x65 lm/W	195x105x136mm	185x95mm

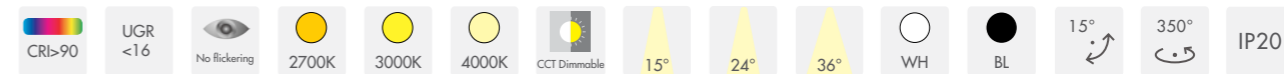

**PRODUCT DATA** 产品参数

Model 型号	Light Source 光源	Power/CCT 功率 / 色温	Light Output 光通量	Light Efficiency 光效率	Size(WxLxH) 尺寸	Cutout 开孔尺寸
IG-GS918516M 01W	COB	2x8W/3000K	≥2x550 lm	≥2x68 lm/W	195x105x60mm	185x95mm

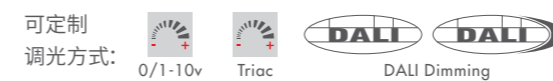

**PHOTOMETRIC** 配光参数

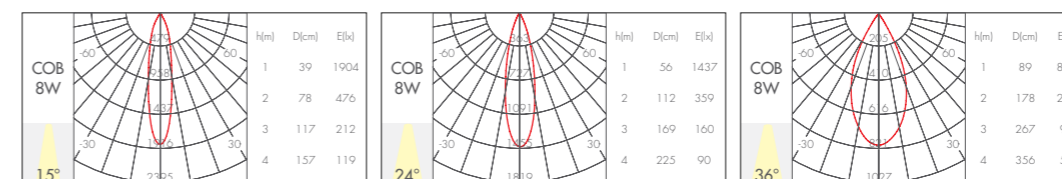

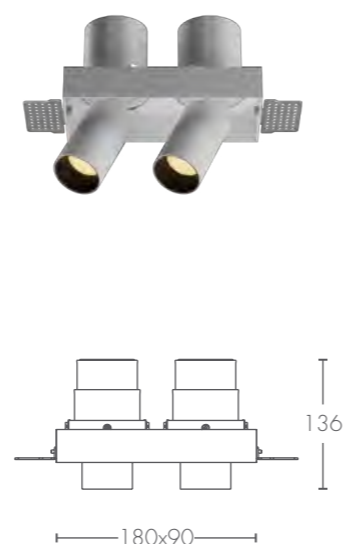
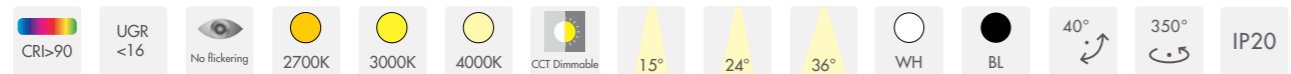

**PRODUCT DATA** 产品参数

Model 型号	Light Source 光源	Power/CCT 功率 / 色温	Light Output 光通量	Light Efficiency 光效率	Size(WxLxH) 尺寸	Cutout 开孔尺寸
IG-GS918516 02W	COB	2x8W/3000K	≥2x552 lm	≥2x69 lm/W	180x90x136mm	180x90mm



**PHOTOMETRIC** 配光参数

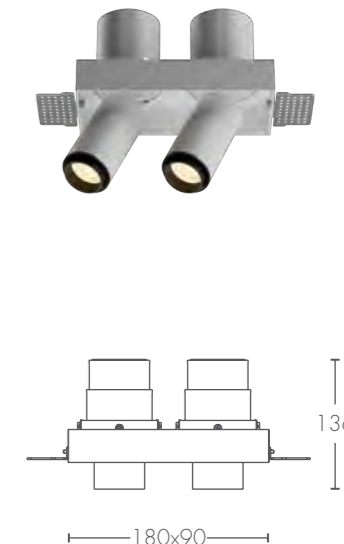
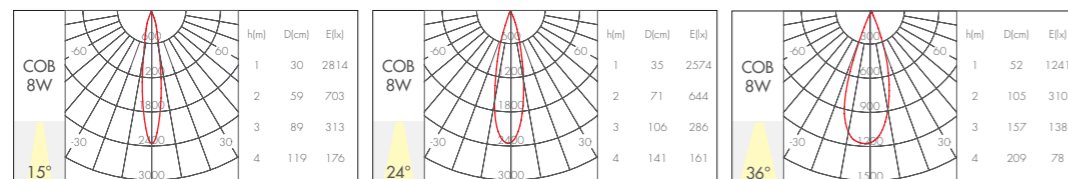

**PRODUCT DATA** 产品参数

Model 型号	Light Source 光源	Power/CCT 功率 / 色温	Light Output 光通量	Light Efficiency 光效率	Size(WxLxH) 尺寸	Cutout 开孔尺寸
IG-GS918516T 02W	COB	2x8W/3000K	≥2x520 lm	≥2x65 lm/W	180x90x136mm	180x90mm

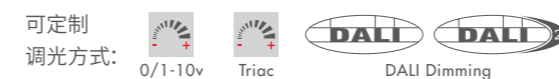

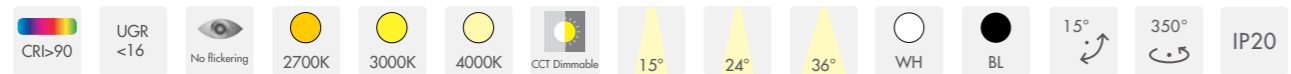

**PRODUCT DATA** 产品参数

Model 型号	Light Source 光源	Power/CCT 功率/色温	Light Output 光通量	Light Efficiency 光效率	Size(WxLxH) 尺寸	Cutout 开孔尺寸
IG-GS918516M 02W	COB	2x8W/3000K	≥2x550 lm	≥2x68 lm/W	180x90x60mm	180x90mm



**PHOTOMETRIC** 配光参数

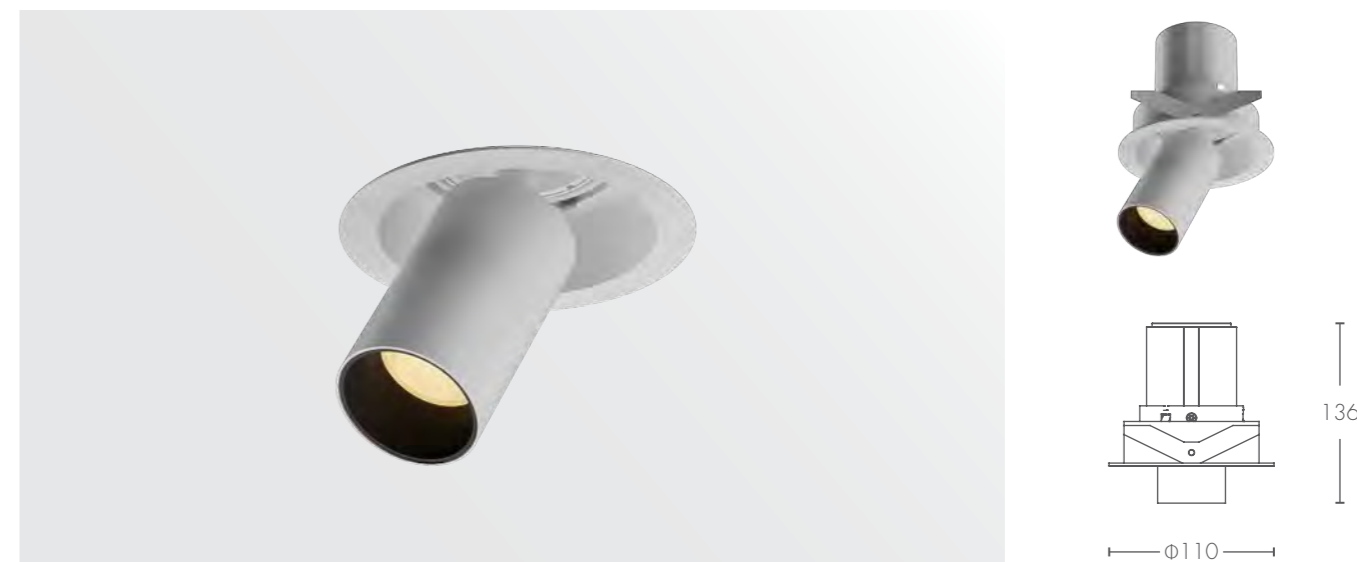
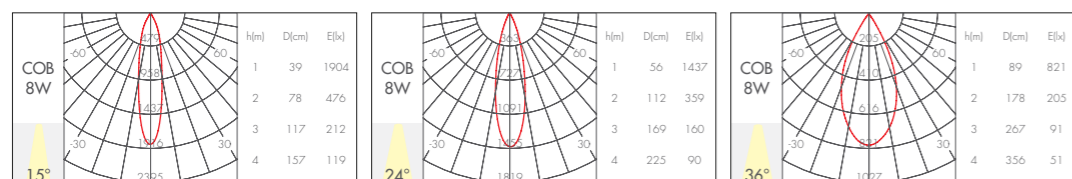

**PRODUCT DATA** 产品参数

Model 型号	Light Source 光源	Power/CCT 功率/色温	Light Output 光通量	Light Efficiency 光效率	Size(DxH) 尺寸	Cutout 开孔尺寸
IG-TH909508 03W	COB	8W/3000K	≥552 lm	≥69 lm/W	Φ110x136mm	Φ95mm



**PHOTOMETRIC** 配光参数

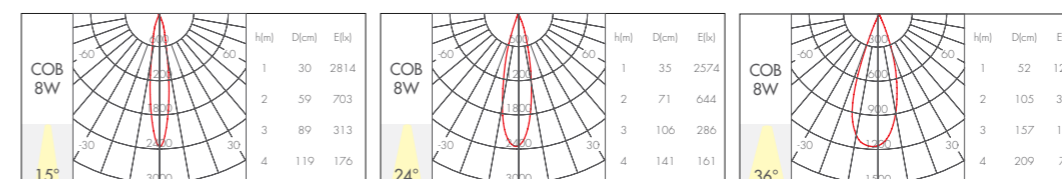



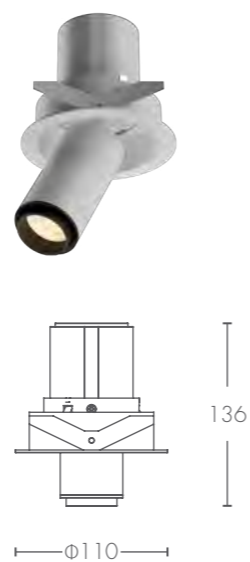

**PRODUCT DATA** 产品参数

Model 型号	Light Source 光源	Power/CCT 功率/色温	Light Output 光通量	Light Efficiency 光效率	Size(DxH) 尺寸	Cutout 开孔尺寸
IG-TH909508T 03W	COB	8W/3000K	≥520 lm	≥65 lm/W	Φ110x136mm	Φ95mm

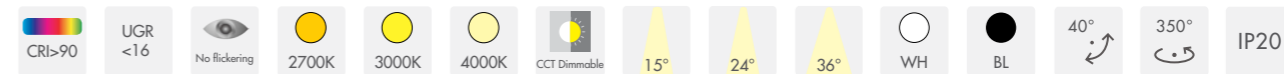

**PRODUCT DATA** 产品参数

Model 型号	Light Source 光源	Power/CCT 功率/色温	Light Output 光通量	Light Efficiency 光效率	Size(DxH) 尺寸	Cutout 开孔尺寸
IG-TH909508M 03W	COB	8W/3000K	≥550 lm	≥68 lm/W	Φ110x60mm	Φ95mm



**PHOTOMETRIC** 配光参数

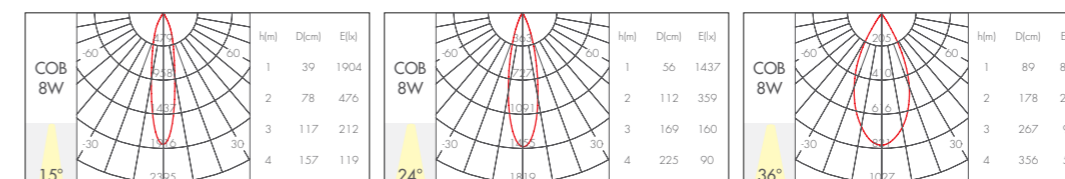

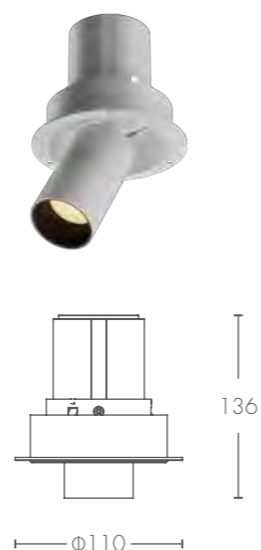

**PRODUCT DATA** 产品参数

Model 型号	Light Source 光源	Power/CCT 功率/色温	Light Output 光通量	Light Efficiency 光效率	Size(DxH) 尺寸	Cutout 开孔尺寸
IG-TH909508 04W	COB	8W/3000K	≥552 lm	≥69 lm/W	Φ110x136mm	Φ90mm



**PHOTOMETRIC** 配光参数

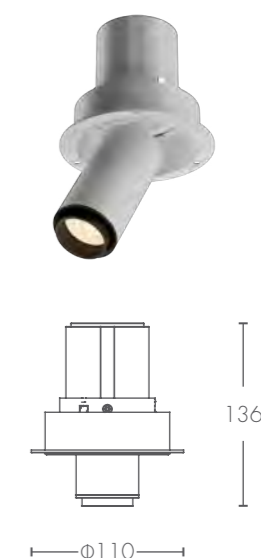
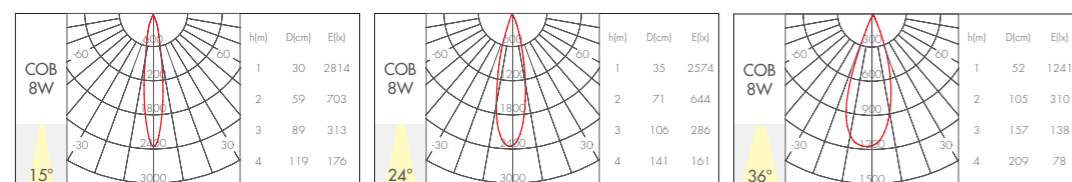

**PRODUCT DATA** 产品参数

Model 型号	Light Source 光源	Power/CCT 功率/色温	Light Output 光通量	Light Efficiency 光效率	Size(DxH) 尺寸	Cutout 开孔尺寸
IG-TH909508T 04W	COB	8W/3000K	≥520 lm	≥65 lm/W	Φ110x136mm	Φ90mm



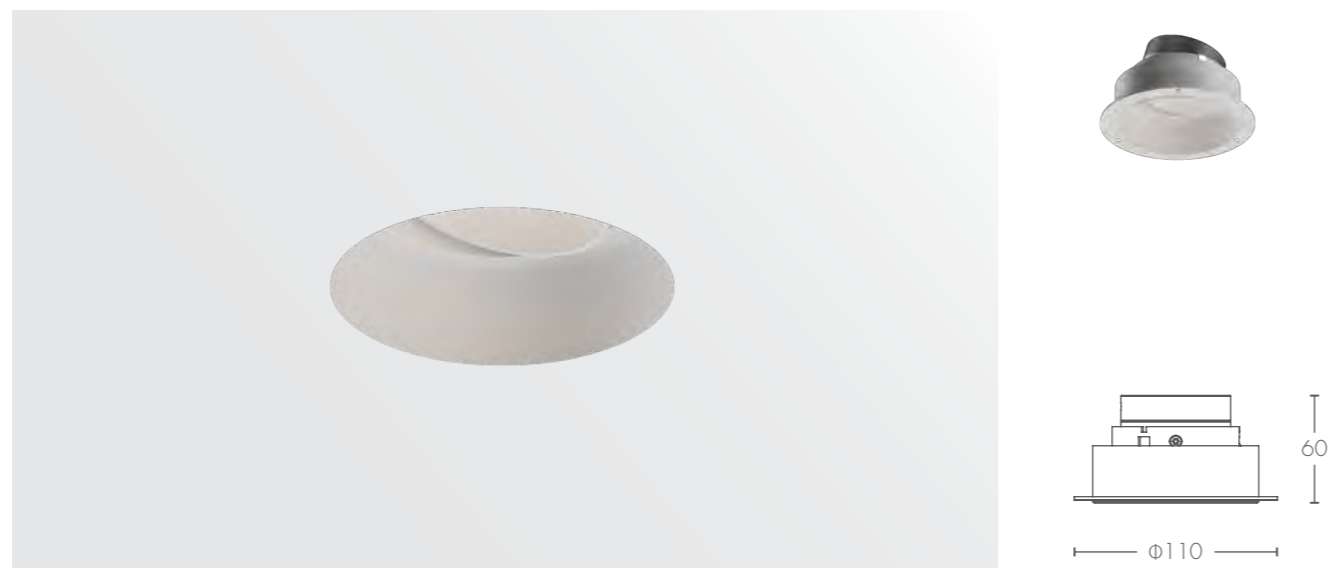
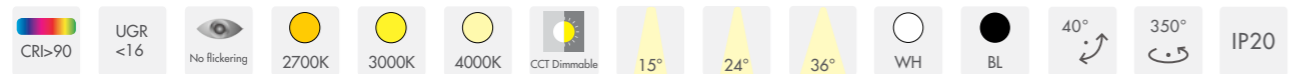

**PRODUCT DATA** 产品参数

Model 型号	Light Source 光源	Power/CCT 功率/色温	Light Output 光通量	Light Efficiency 光效率	Size(DxH) 尺寸	Cutout 开孔尺寸
IG-TH909508M 04W	COB	8W/3000K	≥550 lm	≥68 lm/W	Φ110x60mm	Φ90mm



**PHOTOMETRIC** 配光参数

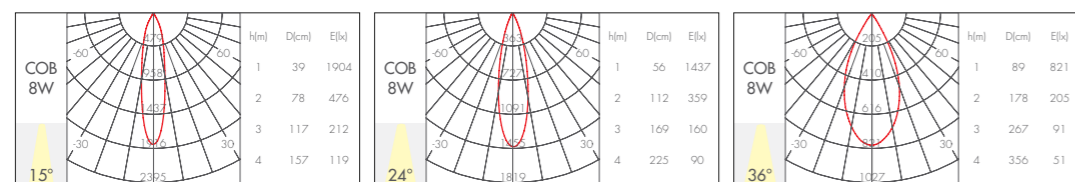

- 模组水平方向转动 350°，垂直 40°，可满足不同照射角度。
- 弹簧 / 无边框设计，灯具与安装天花完美结合，提升空间视觉的一致性。
- 灯体可实现向下向上自由拉伸，满足不同层高需求。
- 单双头方形有边 / 单双头方形无边 / 单头圆形有边 / 单头圆形无边多种规格可选，满足不同场所的照明需求。



#### 市场应用:

店铺、星级酒店、高端别墅、会所、民宿、超市、商业综合体、展览及博物馆等

#### Applications:

Shops, star hotels, high-end villas, clubs, lodging houses, supermarkets, commercial complexes, exhibitions and museums, etc.

#### 产品特性描述:

1. 国际进口品牌光源, CRI > 80/90, 光效高、性能稳定, 光色一致性高;
2. 国标铝材灯体和冷锻散热器, 确保灯具良好外观成型及充分的散热;
3. 优异配光设计并使用国内著名反射器, 光晕自然舒适, 光形好, 峰值光强度高;
4. 内置隔离恒流驱动, 外观简洁、质量稳定;
5. 产品深防眩设计, 防眩角大于 35 度;
6. 系列化产品, 款款经典, 可满足不同场合使用要求;
7. 整灯寿命长达 30000 小时。

#### Product Features:

1. The international import brand light source, CRI > 80/90, has high luminous efficiency, stable performance and high consistency of light and color.
2. High quality aluminum heat sink to ensure ingenious shape and increase heat dissipation space.
3. Excellent precision optical design with high quality reflector, to realise a clear light shape and high peak intensity.
4. High quality isolated constant current driver. Dimming, intelligent control functions for option.
5. Deep anti glare design, anti glare angle greater than 35 degrees.
6. Serialized products, classic design, fit for different applications.
7. Lifespan up to 30,000 hours.

# 魅影 PHANTOM

#### 天花灯

Ceiling spotlight

Page. 160



5W

8W

12W/15W

5W

8W

20W

35W

#### 筒灯

Downlight

Page. 170



5W

7W

12W



- 
- 
- 
- 
- 
- 
- 
- 
- 
- 
- 
- 
- 
- 

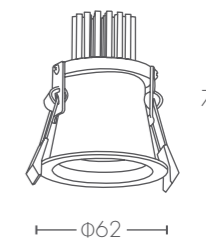
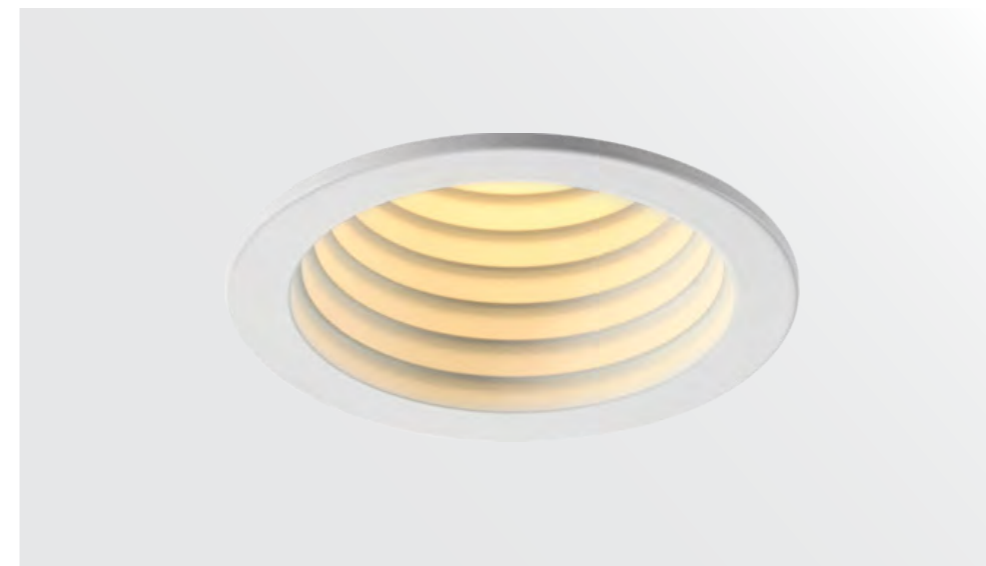

**PRODUCT DATA** 产品参数

Model 型号	Light Source 光源	Power/CCT 功率/色温	Light Output 光通量	Light Efficiency 光效率	Size(DxH) 尺寸	Cutout 开孔尺寸
IG-XQ505505 01	COB	5W/3000K	≥385 lm	≥64 lm/W	Φ62x78mm	Φ55mm

- 可定制  
调光方式:
- - 
  -

**PHOTOMETRIC** 配光参数

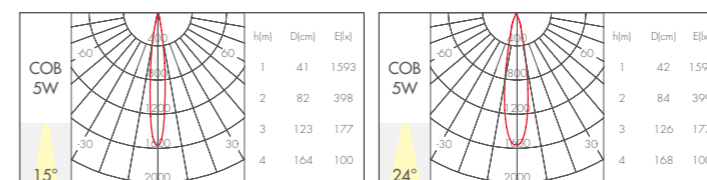

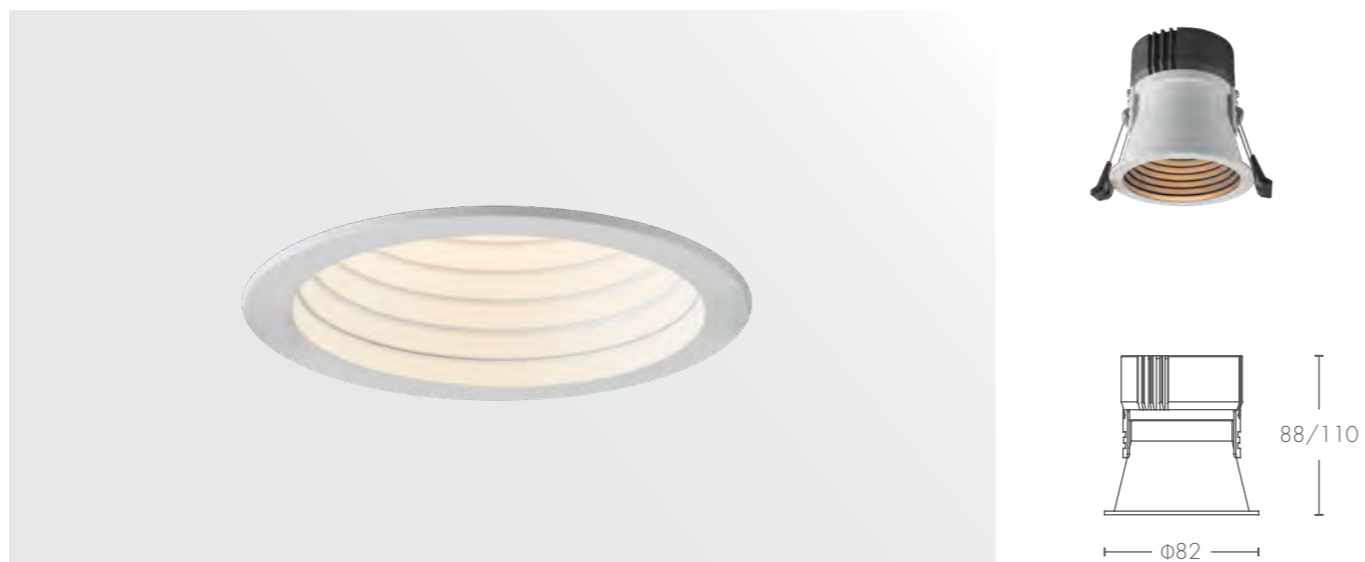
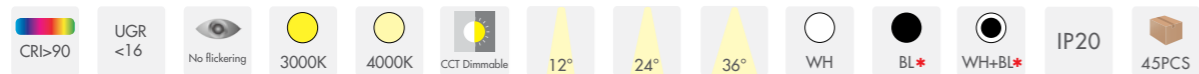

**PRODUCT DATA** 产品参数

Model 型号	Light Source 光源	Power/CCT 功率/色温	Light Output 光通量	Light Efficiency 光效率	Size(DxH) 尺寸	Cutout 开孔尺寸
IG-XQ507508 02	COB	8W/3000K	≥480 lm	≥60 lm/W	Φ82x88mm	Φ75mm
IG-XQ507512 02	COB	12W/3000K	≥720 lm	≥60 lm/W	Φ82x110mm	Φ75mm



**PHOTOMETRIC** 配光参数

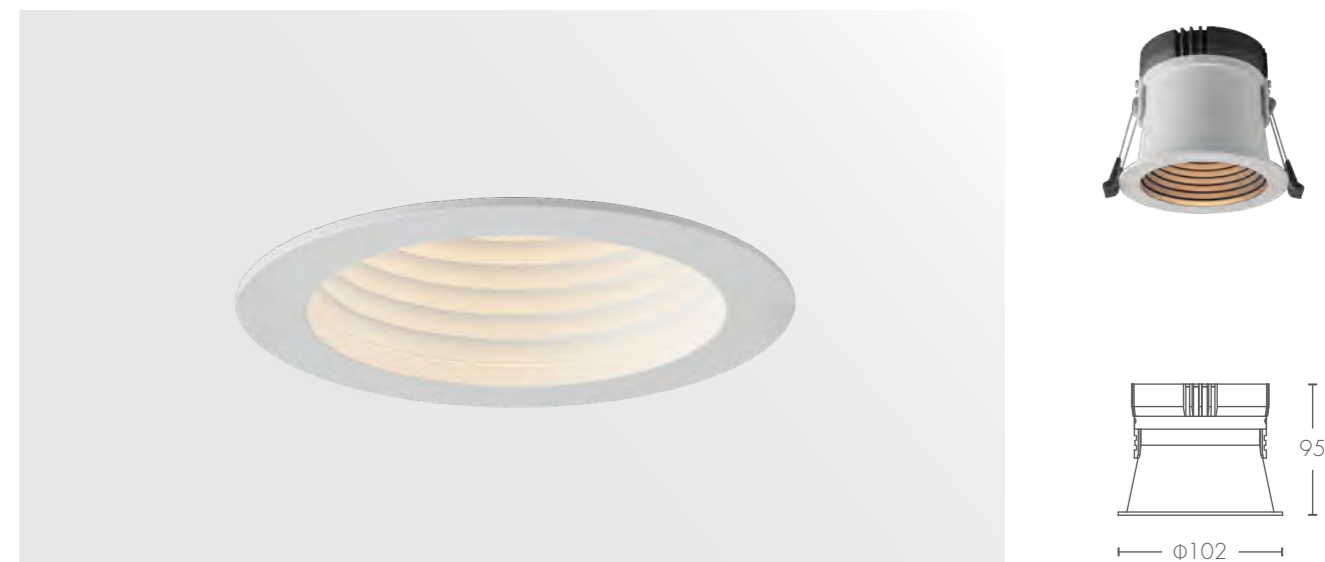
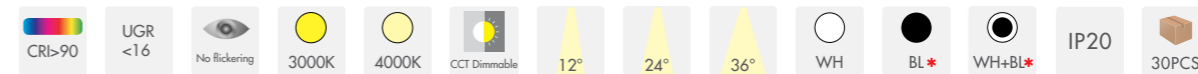
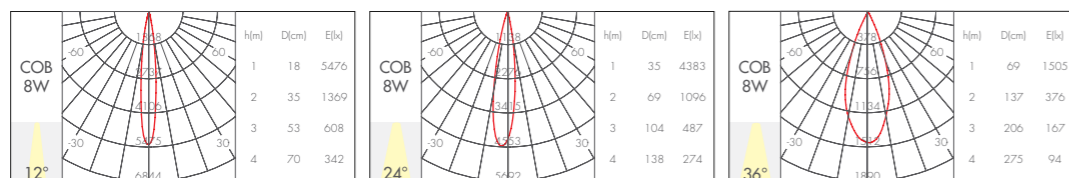

**PRODUCT DATA** 产品参数

Model 型号	Light Source 光源	Power/CCT 功率/色温	Light Output 光通量	Light Efficiency 光效率	Size(DxH) 尺寸	Cutout 开孔尺寸
IG-XQ509512 02	COB	12W/3000K	≥600 lm	≥50 lm/W	Φ102x95mm	Φ92mm
IG-XQ509515 02	COB	15W/3000K	≥750 lm	≥50 lm/W	Φ102x95mm	Φ92mm



**PHOTOMETRIC** 配光参数

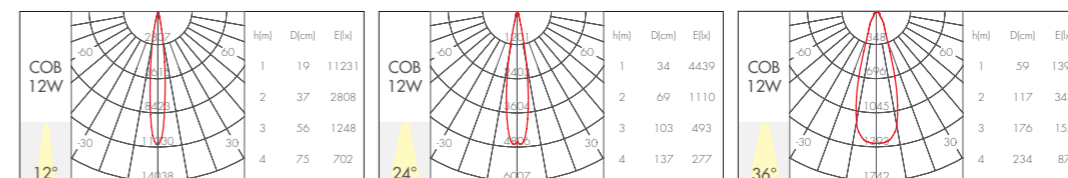



- CRI>90
- UGR <16
- No flickering
- 3000K
- 4000K
- CCT Dimmable
- 15°
- 24°
- 36°
- WH
- BL\*
- GR\*
- 25°
- IP20
- 45PCS

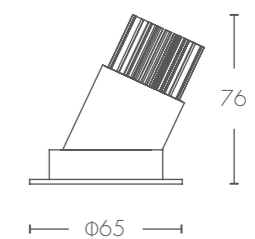

**PRODUCT DATA** 产品参数

Model 型号	Light Source 光源	Power/CCT 功率 / 色温	Light Output 光通量	Light Efficiency 光效率	Size(DxH) 尺寸	Cutout 开孔尺寸
IG-XQ505505 05	COB	5W/3000K	≥340 lm	≥57 lm/W	Φ65x76mm	Φ55mm

- 可定制  
调光方式:
- 0/1-10v
  - Triac
  - DALI Dimming

**PHOTOMETRIC** 配光参数

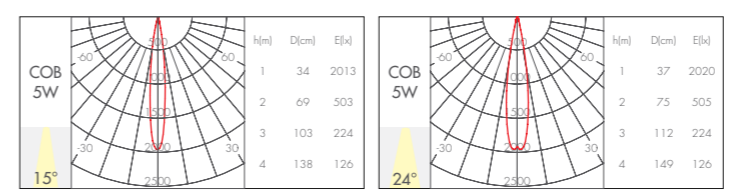

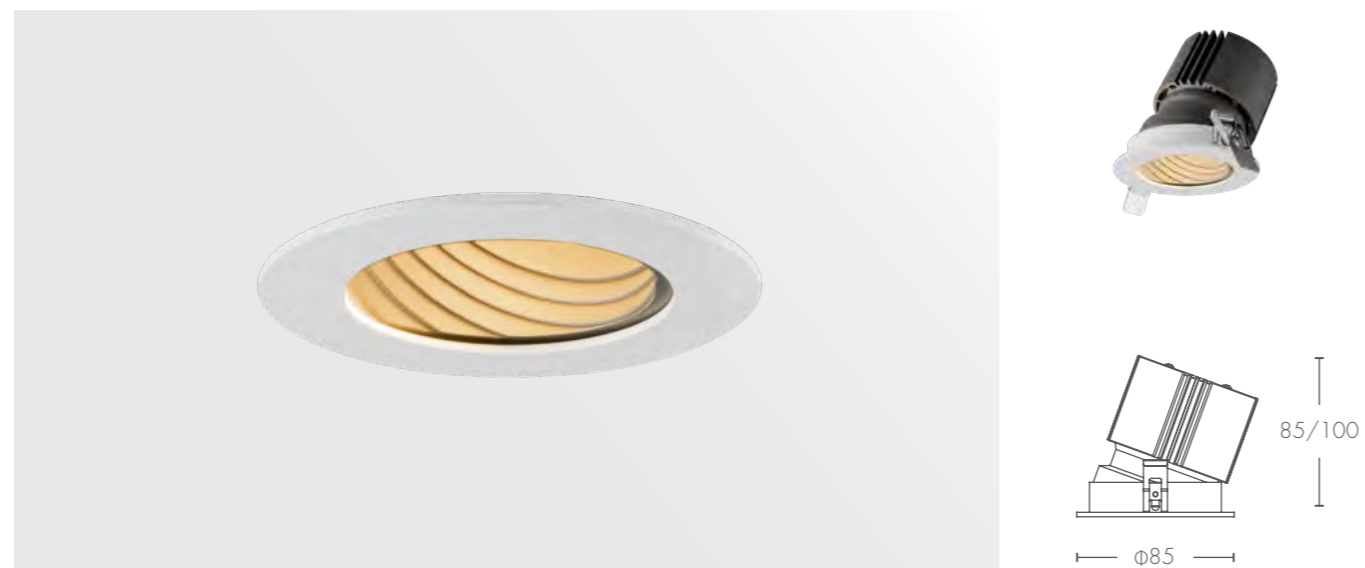

**PRODUCT DATA** 产品参数

Model 型号	Light Source 光源	Power/CCT 功率/色温	Light Output 光通量	Light Efficiency 光效率	Size(DxH) 尺寸	Cutout 开孔尺寸
IG-XQ507508 06	COB	8W/3000K	≥480 lm	≥60 lm/W	Φ85x85mm	Φ75mm
IG-XQ507512 06	COB	12W/3000K	≥720 lm	≥60 lm/W	Φ85x100mm	Φ75mm

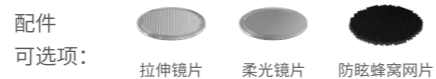

**PHOTOMETRIC** 配光参数

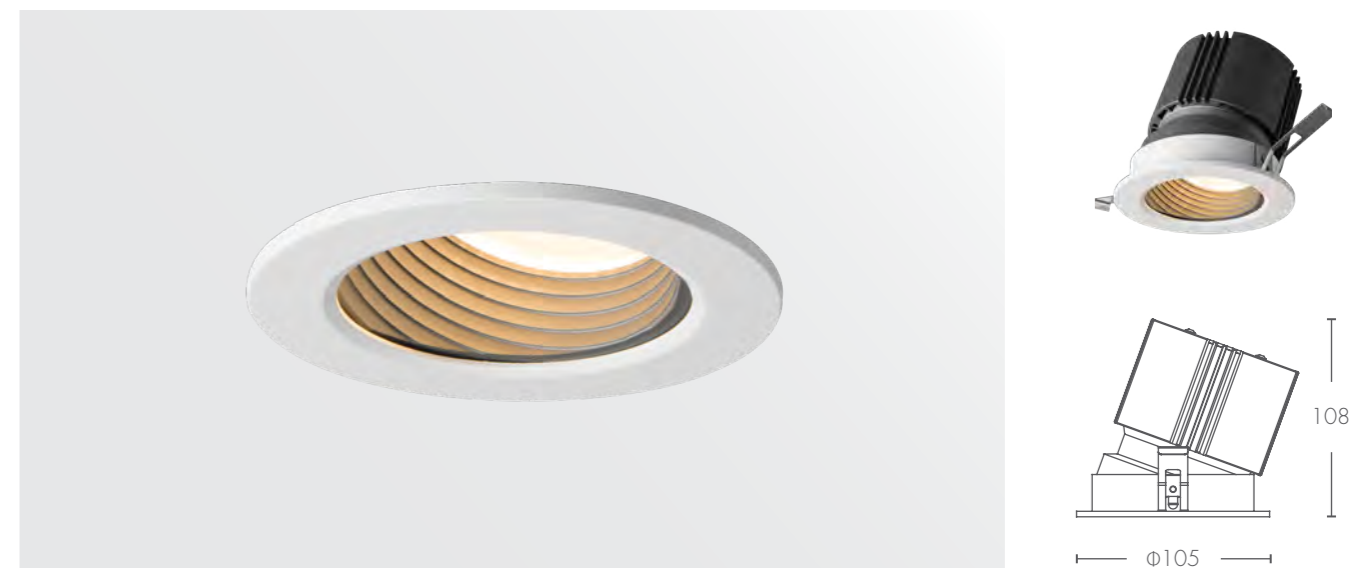
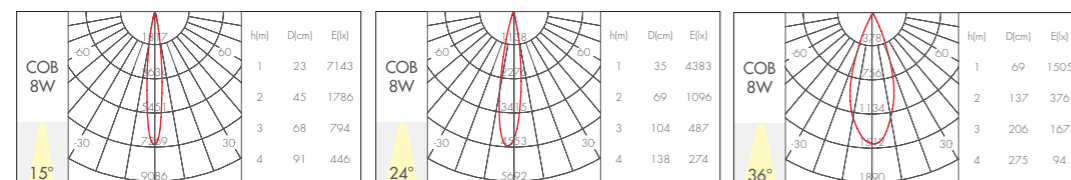

**PRODUCT DATA** 产品参数

Model 型号	Light Source 光源	Power/CCT 功率/色温	Light Output 光通量	Light Efficiency 光效率	Size(DxH) 尺寸	Cutout 开孔尺寸
IG-TH709520 01	COB	20W/3000K	≥1300 lm	≥65 lm/W	Φ105x108mm	Φ95mm

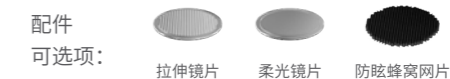

**PHOTOMETRIC** 配光参数

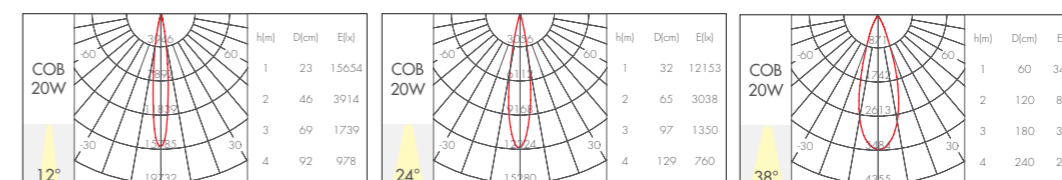





CRI>90   UGR <16   No flickering   3000K   4000K   CCT Dimmable   12°   24°   36°   WH   BL   25°   IP20   12PCS

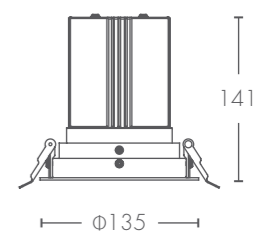

**PRODUCT DATA** 产品参数







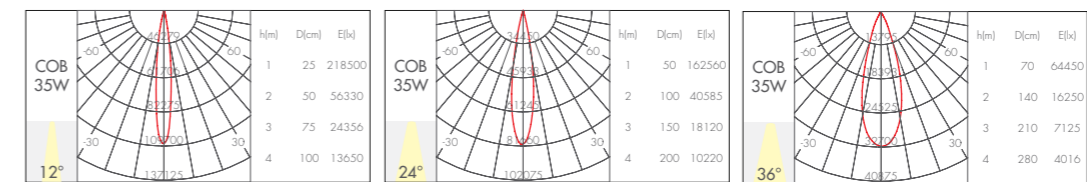

Model 型号	Light Source 光源	Power/CCT 功率 / 色温	Light Output 光通量	Light Efficiency 光效率	Size(DxH) 尺寸	Cutout 开孔尺寸
IG-TH512535	COB	35W/3000K	≥2588 lm	≥75 lm/W	Φ135x141mm	Φ125mm

可定制  
 调光方式: 0/1-10v   Triac   DALI   DALI 2   DALI Dimming

**PHOTOMETRIC** 配光参数





-  CRI>80
-  UGR <19
-  No flickering
-  3000K
-  4000K
-  60°
-  WH
-  BL\*
-  IP20
-  45PCS

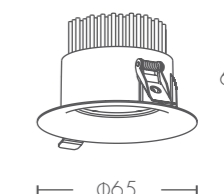

### PRODUCT DATA 产品参数

Model 型号	Light Source 光源	Power/CCT 功率 / 色温	Light Output 光通量	Light Efficiency 光效率	Size(DxH) 尺寸	Cutout 开孔尺寸
IG-TD505505 01	COB	5W/4000K	≥350 lm	≥65 lm/W	Φ65x61mm	Φ55mm

### PHOTOMETRIC 配光参数

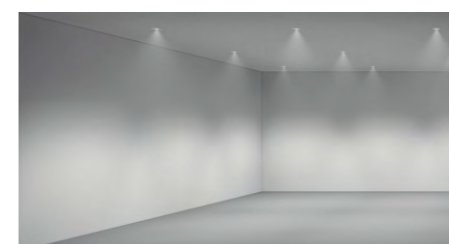
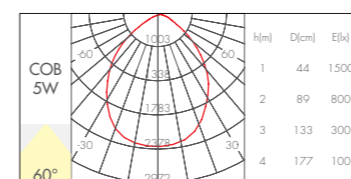

CRI>80
 UGR <19
 No flickering
 3000K
 4000K
 60°
 WH
 BL\*
 IP20
 45PCS

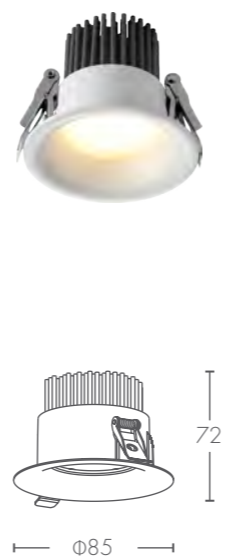

**PRODUCT DATA** 产品参数

Model 型号	Light Source 光源	Power/CCT 功率 / 色温	Light Output 光通量	Light Efficiency 光效率	Size(DxH) 尺寸	Cutout 开孔尺寸
IG-TD507507 02	SMD	7W/4000K	≥560 lm	≥80 lm/W	Φ85x72mm	Φ75mm

**PHOTOMETRIC** 配光参数

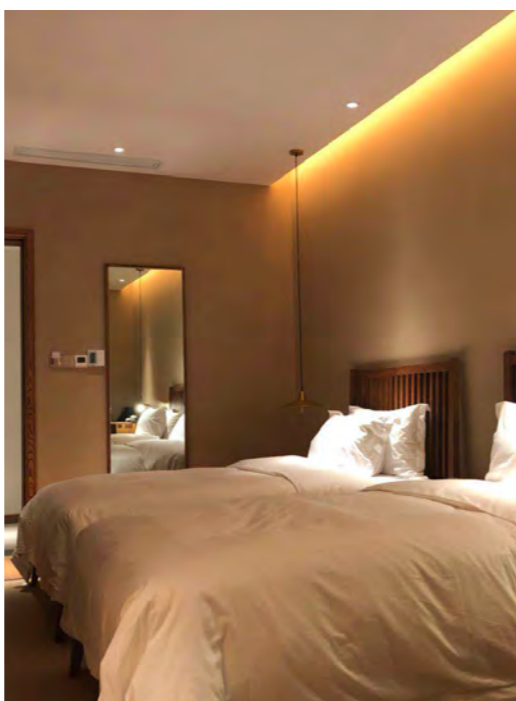
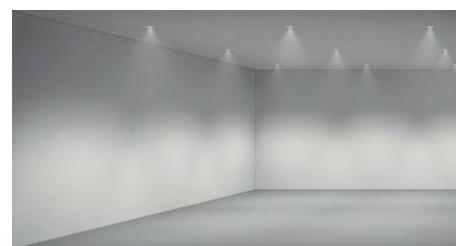
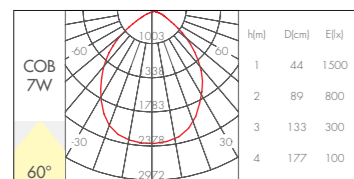

CRI>80
 UGR <19
 No flickering
 3000K
 4000K
 60°
 WH
 BL\*
 IP20
 30PCS

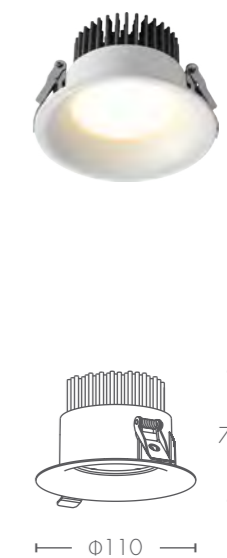

**PRODUCT DATA** 产品参数

Model 型号	Light Source 光源	Power/CCT 功率 / 色温	Light Output 光通量	Light Efficiency 光效率	Size(DxH) 尺寸	Cutout 开孔尺寸
IG-TD509212 03	SMD	12W/4000K	≥960 lm	≥80 lm/W	Φ110x70mm	Φ95mm

**PHOTOMETRIC** 配光参数

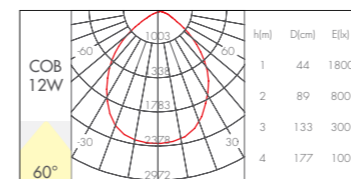

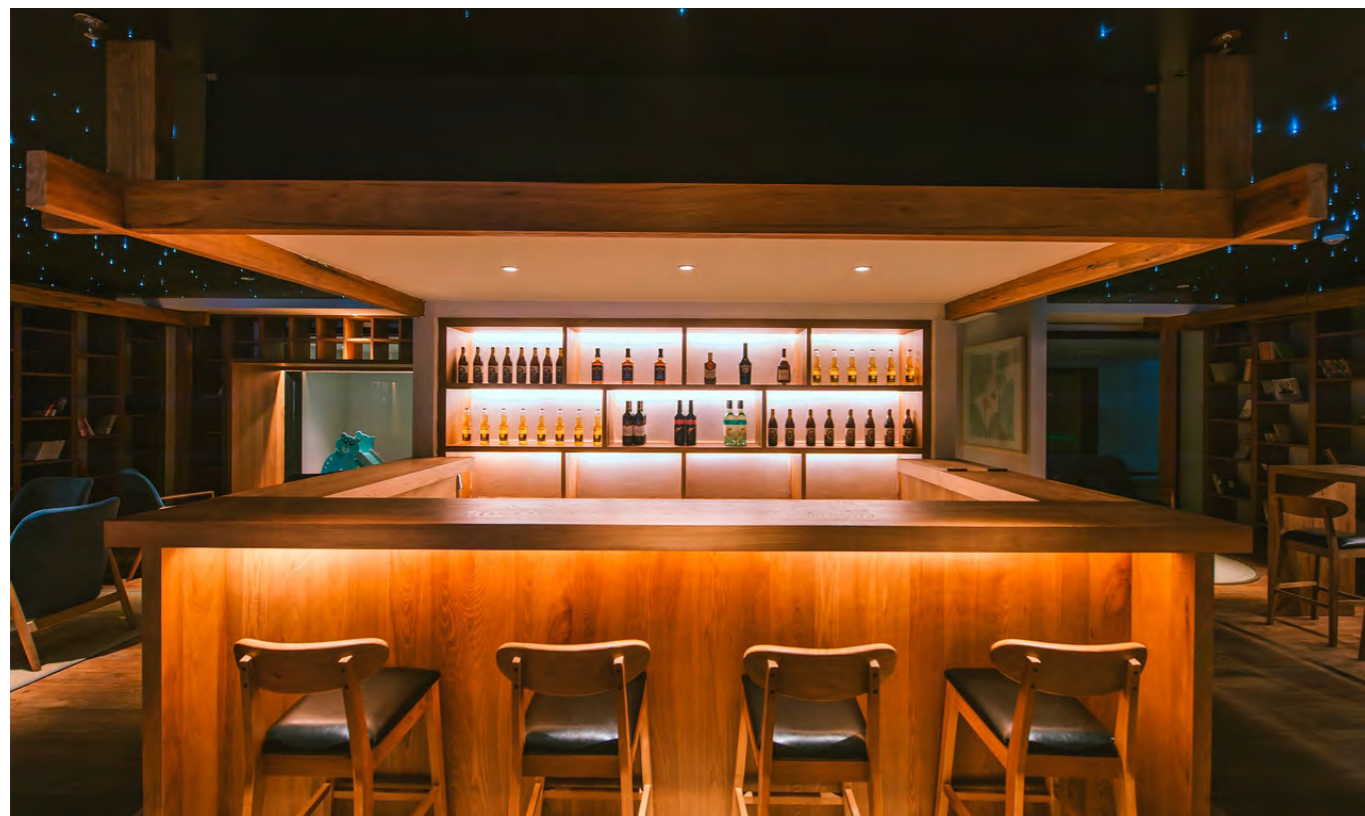

#### 市场应用:

店铺、星级酒店、高端别墅、会所、民宿、超市、商业综合体、展览及博物馆等

#### Applications:

Shops, star hotels, high-end villas, clubs, lodging houses, supermarkets, commercial complexes, exhibitions and museums, etc.

#### 产品特性描述:

1. 国际进口品牌 COB 光源, CRI > 80/90, 光效高、性能稳定, 光色一致性高;
2. 国标铝材灯体和高导热铝散热器, 确保灯具良好外观成型及充分的散热;
3. 优异配光设计并使用国内著名反射器, 光晕自然舒适, 光形好, 峰值光强度高;
4. 内置或外置恒流驱动, 外观简洁、质量稳定;
5. 产品深防眩设计, 防眩角大于 35 度;
6. 系列化产品, 款款经典, 可满足不同场合使用要求;
7. 整灯寿命长达 30000 小时。

#### Product Features:

1. The international imported brand COB light source, CRI > 80/90, has high luminous efficiency, stable performance and high consistency of light and color.
2. National standard aluminum lamp body and high thermal conductivity aluminum radiator to ensure good appearance and adequate heat dissipation for lamps and lanterns.
3. Excellent precision optical design with high quality reflector, to realise a clear light shape and high peak intensity.
4. Built in or external constant current drive, simple appearance and stable quality.
5. Deep anti glare design, anti glare angle greater than 35 degrees.
6. Serialized products, classic design, fit for different applications.
7. Lifespan up to 30,000 hours.

# 卡兹 KATZ

#### 洗墙灯 Wallwasher

Page. 176



8W/12W

8W/12W

8W/12W

8W/12W

#### 防水天花灯 Ceiling spotlight

Page. 182

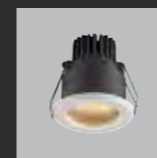

8W



- CRI > 90
- UGR < 19
- No flickering
- 3000K
- 4000K
- CCT Dimmable
- 15°
- 24°
- 36°
- WH
- BL\*
- GR\*
- 30°
- IP20
- 45PCS

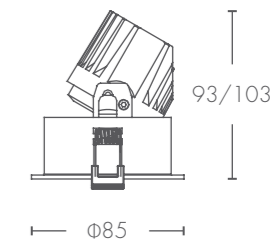

### PRODUCT DATA 产品参数

Model 型号	Light Source 光源	Power/CCT 功率/色温	Light Output 光通量	Light Efficiency 光效率	Size(DxH) 尺寸	Cutout 开孔尺寸
IG-XQ307508 01	COB	8W/3000K	≥400 lm	≥50 lm/W	Ø85x93mm	Ø75mm
IG-XQ307512 01	COB	12W/3000K	≥600 lm	≥50 lm/W	Ø85x103mm	Ø75mm

可定制  
调光方式:



配件  
可选项:

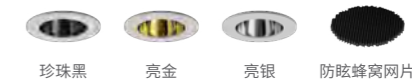

### PHOTOMETRIC 配光参数

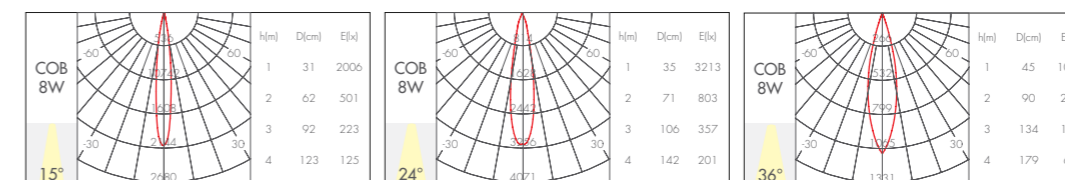

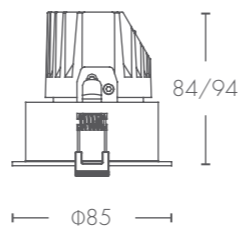
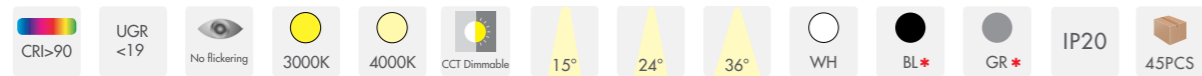

**PRODUCT DATA** 产品参数

Model 型号	Light Source 光源	Power/CCT 功率/色温	Light Output 光通量	Light Efficiency 光效率	Size(DxH) 尺寸	Cutout 开孔尺寸
IG-XQ307508 02	COB	8W/3000K	≥400 lm	≥50 lm/W	Φ85x84mm	Φ75mm
IG-XQ307512 02	COB	12W/3000K	≥600 lm	≥50 lm/W	Φ85x94mm	Φ75mm



**PHOTOMETRIC** 配光参数

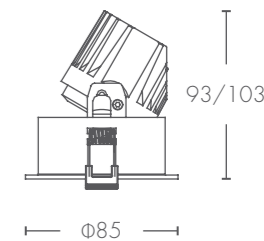
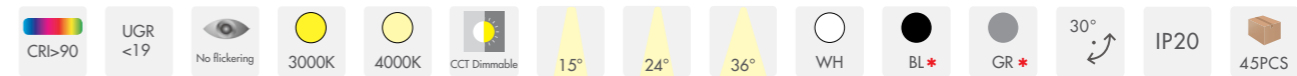
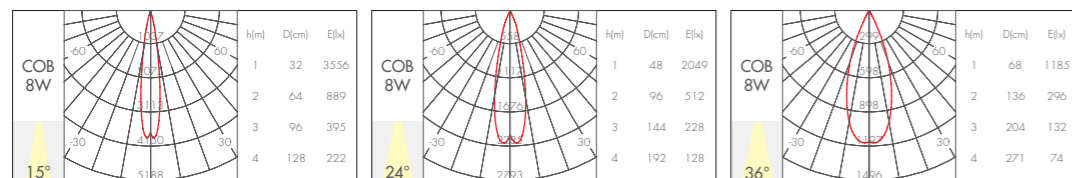

**PRODUCT DATA** 产品参数

Model 型号	Light Source 光源	Power/CCT 功率/色温	Light Output 光通量	Light Efficiency 光效率	Size(DxH) 尺寸	Cutout 开孔尺寸
IG-XQ307508 03	COB	8W/3000K	≥320 lm	≥40 lm/W	Φ85x93mm	Φ75mm
IG-XQ307512 03	COB	12W/3000K	≥480 lm	≥40 lm/W	Φ85x103mm	Φ75mm



**PHOTOMETRIC** 配光参数

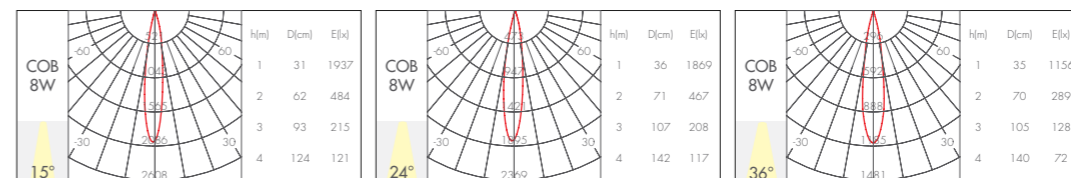

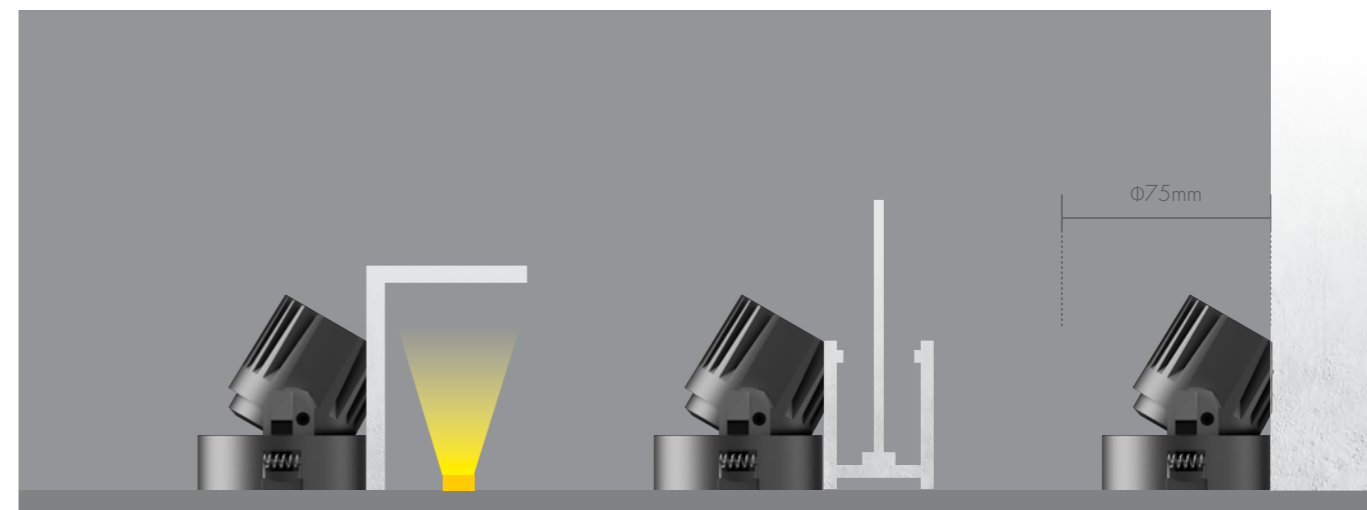
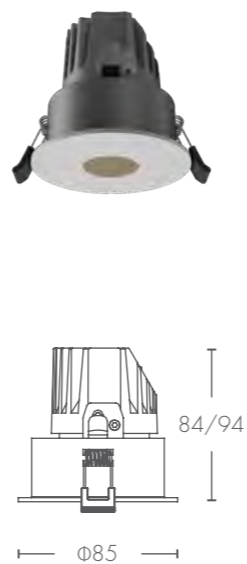

天花灯槽

吊顶龙骨

横梁

**PRODUCT DATA** 产品参数

Model 型号	Light Source 光源	Power/CCT 功率/色温	Light Output 光通量	Light Efficiency 光效率	Size(DxH) 尺寸	Cutout 开孔尺寸
IG-XQ307508 04	COB	8W/3000K	≥280 lm	≥35 lm/W	Φ85x84mm	Φ75mm
IG-XQ307512 04	COB	12W/3000K	≥420 lm	≥35 lm/W	Φ85x94mm	Φ75mm



**PHOTOMETRIC** 配光参数

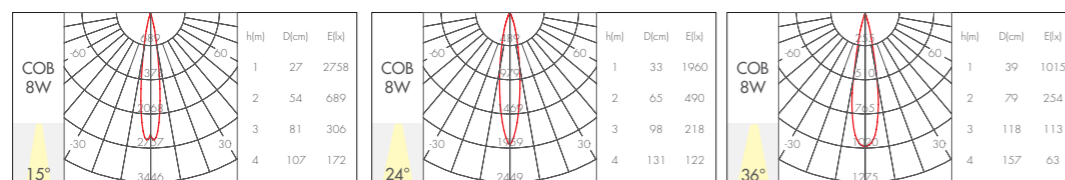

- 维纳斯散热结构能让灯体能在狭小空间中灵活自如、自由摆角、最大可调 30°
- 解决一切天花板上的障碍

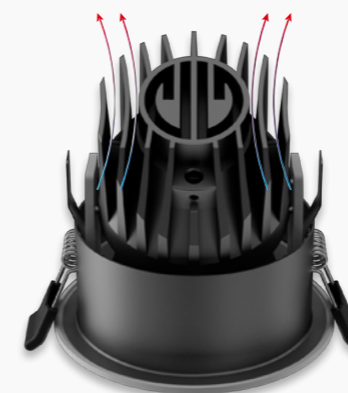

- 维纳斯散热器、功能与艺术结合
- 保持一贯精准控光特点、光形出众
- 灯具预埋设计，安装快捷，维护方便



- CRI>90
- No flickering
- 3000K
- 4000K
- CCT Dimmable
- 15°
- 24°
- 36°
- WH+BL
- IP54
- 45PCS

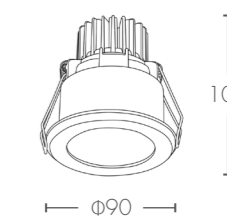

**PRODUCT DATA** 产品参数

Model 型号	Light Source 光源	Power/CCT 功率/色温	Light Output 光通量	Light Efficiency 光效率	Size(DxH) 尺寸	Cutout 开孔尺寸
IG-XQ007508 05	COB	8W/3000K	≥549 lm	≥68 lm/W	Φ90x100mm	Φ75mm

- 可定制  
调光方式:
- 0/1-10v
  - Triac
  - DALI
  - DALI 2
- DALI Dimming

**PHOTOMETRIC** 配光参数

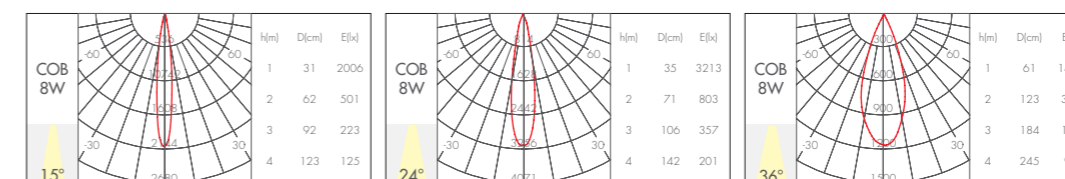





#### 市场应用:

店铺、星级酒店、高端别墅、会所、民宿、超市、商业综合体、展览及博物馆等

#### Applications:

Shops, star hotels, high-end villas, clubs, lodging houses, supermarkets, commercial complexes, exhibitions and museums, etc.

#### 产品特性描述:

1. 国际进口品牌光源, CRI > 80/90, 光效高、性能稳定, 光色一致性高;
2. 国标铝材灯体和冷银散热器, 确保灯具良好外观成型及充分的散热;
3. 优异配光设计并使用国内著名反射器, 光晕自然舒适, 光形好, 峰值光强度高;
4. 内置隔离恒流驱动, 外观简洁、质量稳定;
5. 产品深防眩设计, 防眩角大于 35 度;
6. 系列化产品, 款款经典, 可满足不同场合使用要求;
7. 整灯寿命长达 30000 小时。

#### Product Features:

1. The international import brand light source, CRI > 80/90, has high luminous efficiency, stable performance and high consistency of light and color.
2. High quality aluminum heat sink to ensure ingenious shape and increase heat dissipation space.
3. Excellent precision optical design with high quality reflector, to realise a clear light shape and high peak intensity.
4. High quality isolated constant current driver. Dimming, intelligent control functions for option.
5. Deep anti glare design, anti glare angle greater than 35 degrees.
6. Serialized products, classic design, fit for different applications.
7. Lifespan up to 30,000 hours.

# 黑金 KING

天花灯  
Ceiling spotlight

Page. 186

明装筒灯  
Surface mounted downlight

Page. 210



6W



8W/12W



20W/25W



30W/35W



8W



15W



20W



20W/25W

格栅灯  
Grille spotlight

Page. 192

明装筒灯  
Surface mounted downlight

Page. 216

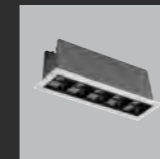

15x2W/10x2W  
5x2W/2x2W/2W

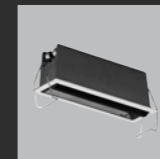

10W/20W/30W



24W/M



12W



20W



10W

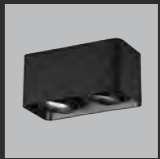

2x10W

无边格栅灯  
Trimless grille spotlight

Page. 202



8W/12W



2x8W/2x12W



3x8W/3x12W



20W



2x20W



3x20W

嵌入式筒灯  
Recessed downlight

Page. 220

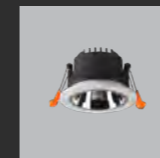

7W



12W



18W



25W



35W



CRi>90
UGR <16
No flickering
3000K
4000K
CCT Dimmable
15°
30°
45°
WH
BL\*
IP20
45PCS

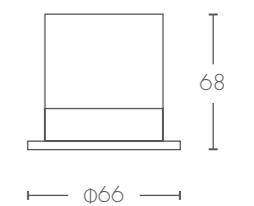

**PRODUCT DATA** 产品参数

Model 型号	Light Source 光源	Power/CCT 功率 / 色温	Light Output 光通量	Light Efficiency 光效率	Size(DxH) 尺寸	Cutout 开孔尺寸
IG-TH106006	COB	6W/3000K	≥275 lm	≥55 lm/W	Φ66x68mm	Φ60mm

可定制  
 调光方式: DALI Dimming

**PHOTOMETRIC** 配光参数

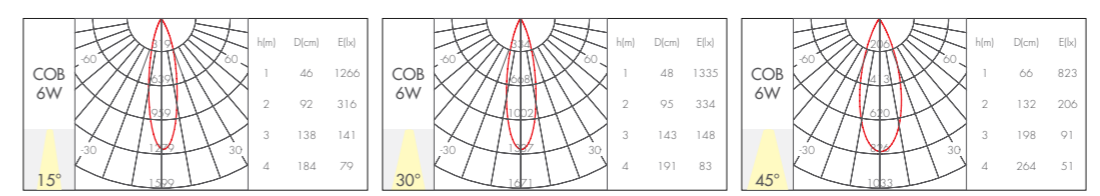

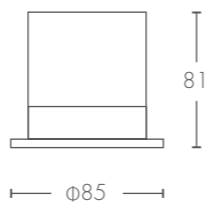
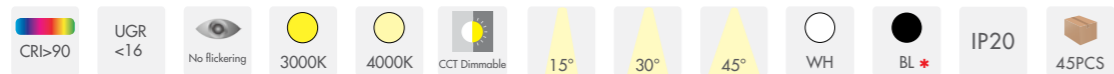

**PRODUCT DATA** 产品参数

Model 型号	Light Source 光源	Power/CCT 功率 / 色温	Light Output 光通量	Light Efficiency 光效率	Size(DxH) 尺寸	Cutout 开孔尺寸
IG-TH107508	COB	8W/3000K	≥440 lm	≥55 lm/W	Φ85x81mm	Φ75mm
IG-TH107512	COB	*12W/3000K	≥660 lm	≥55 lm/W	Φ85x81mm	Φ75mm



**PHOTOMETRIC** 配光参数

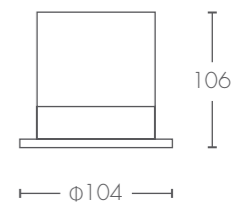
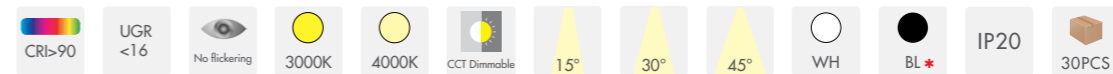
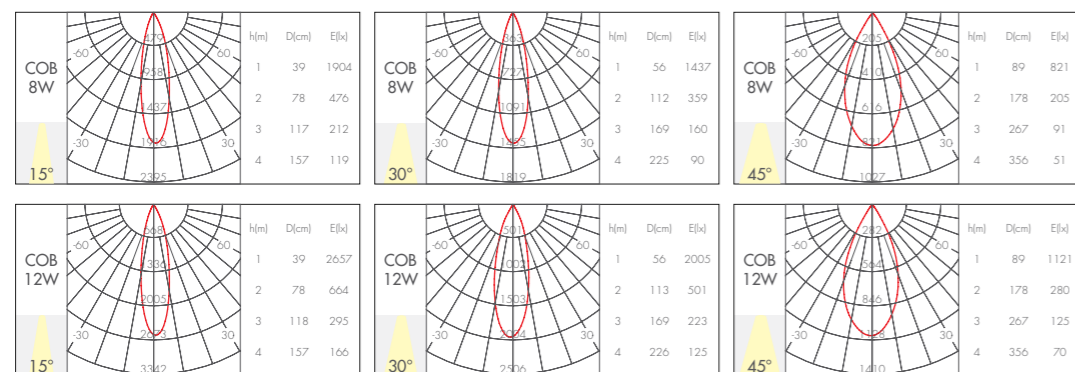

**PRODUCT DATA** 产品参数

Model 型号	Light Source 光源	Power/CCT 功率 / 色温	Light Output 光通量	Light Efficiency 光效率	Size(DxH) 尺寸	Cutout 开孔尺寸
IG-TH109520	COB	20W/3000K	≥1200 lm	≥60 lm/W	Φ104x106mm	Φ95mm
IG-TH109525	COB	*25W/3000K	≥1500 lm	≥60 lm/W	Φ104x106mm	Φ95mm



**PHOTOMETRIC** 配光参数

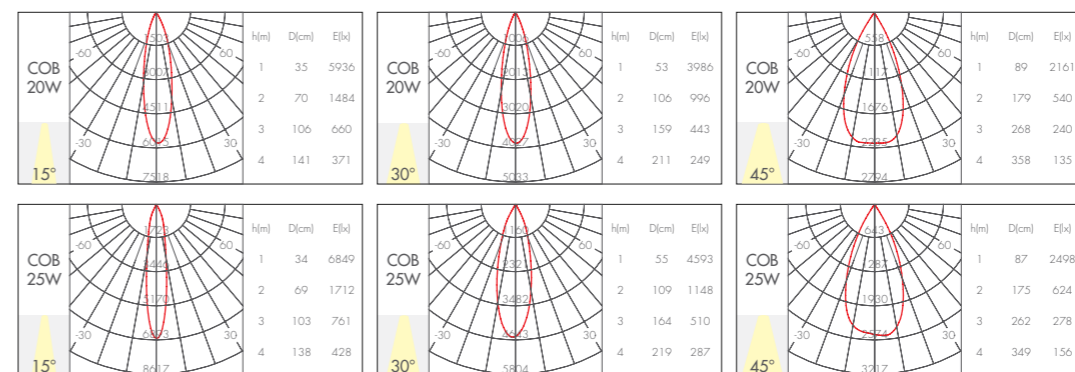

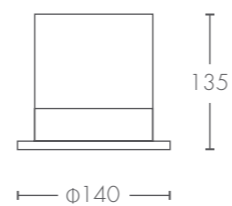

**PRODUCT DATA** 产品参数

Model 型号	Light Source 光源	Power/CCT 功率 / 色温	Light Output 光通量	Light Efficiency 光效率	Size(DxH) 尺寸	Cutout 开孔尺寸
IG-TH112530	COB	30W/3000K	≥1800 lm	≥60 lm/W	Φ140x135mm	Φ125mm
IG-TH112535	COB	35W/3000K	≥1800 lm	≥50 lm/W	Φ140x135mm	Φ125mm



**PHOTOMETRIC** 配光参数

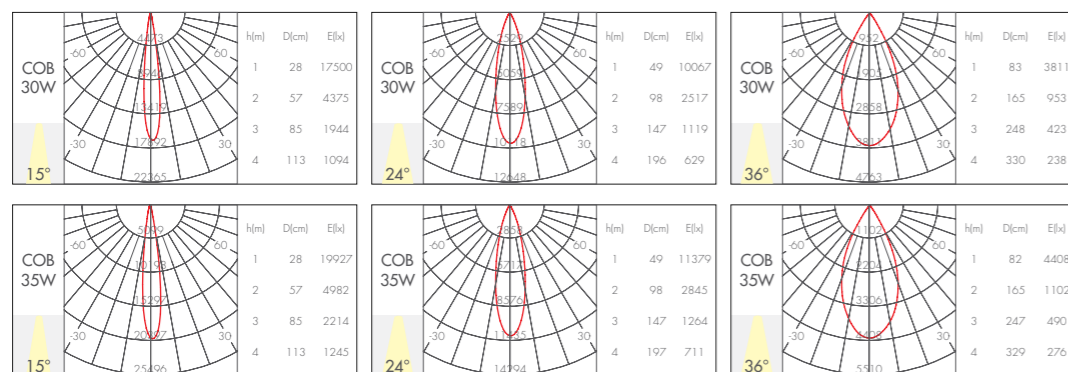

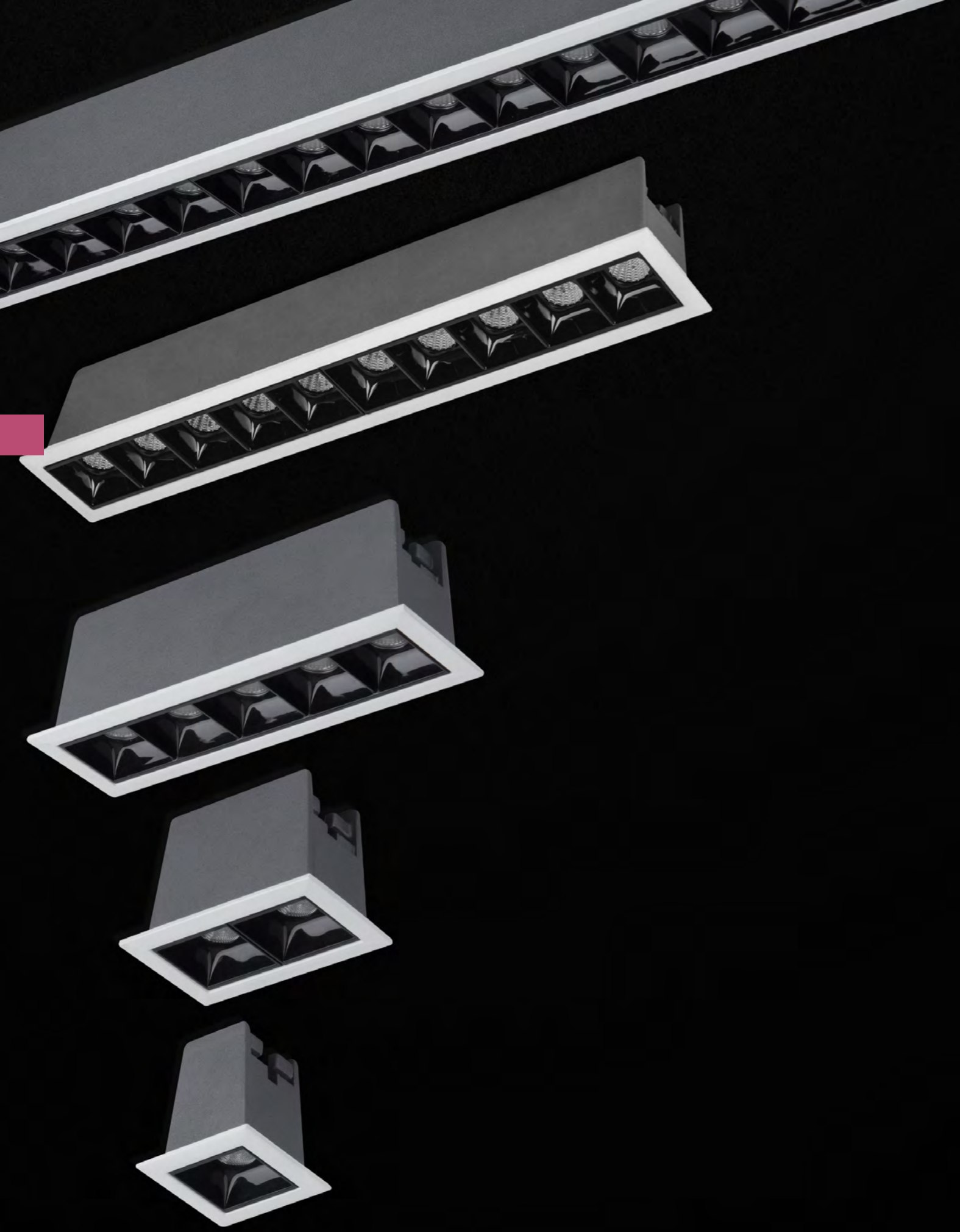

- CRI>85
- UGR <19
- No flickering
- 3000K
- 4000K
- 15°
- 30°
- 45°
- WH
- IP20

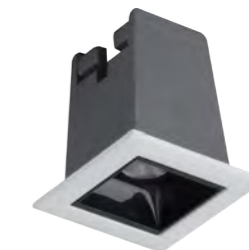
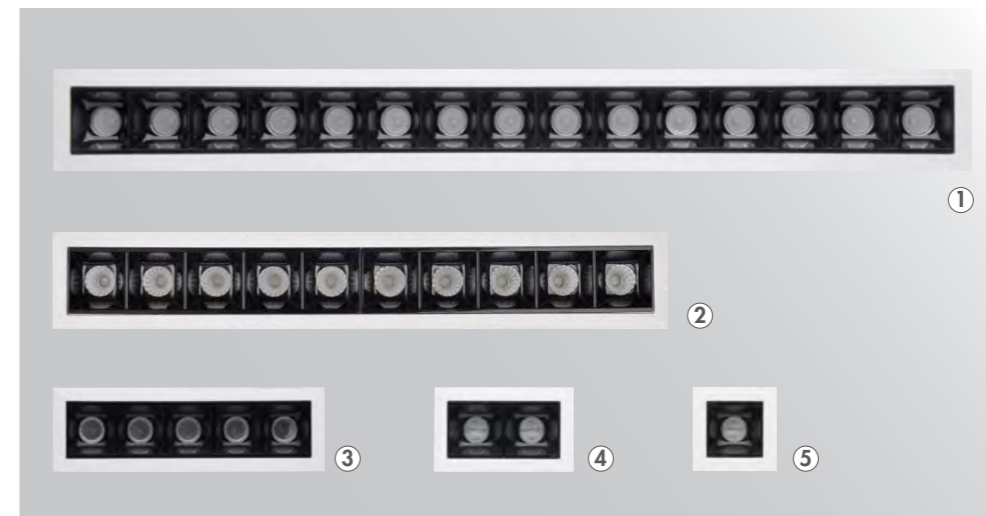

**PRODUCT DATA** 产品参数

Model 型号	Light Source 光源	Power/CCT 功率 / 色温	Light Output 光通量	Light Efficiency 光效率	Size(WxLxH) 尺寸	Cutout 开孔尺寸	Amount/Box 装箱数量
IG-GSA40030 ①	SMD	15x2W/3000K	≥1800 lm	≥60 lm/W	413x45x49mm	405x37mm	15PCS
IG-GSA27320 ②	SMD	10x2W/3000K	≥1200 lm	≥60 lm/W	280x45x49mm	273x37mm	30PCS
IG-GSA13710 ③	SMD	5x2W/3000K	≥600 lm	≥60 lm/W	147x45x49mm	140x37mm	40PCS
IG-GSA06504 ④	SMD	2x2W/3000K	≥240 lm	≥60 lm/W	75x45x49mm	68x37mm	60PCS
IG-GSA04502 ⑤	SMD	2W/3000K	≥120 lm	≥60 lm/W	45x45x49mm	37x37mm	100PCS

可定制  
调光方式: 0/1-10v Triac

**PHOTOMETRIC** 配光参数

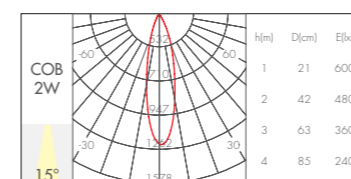

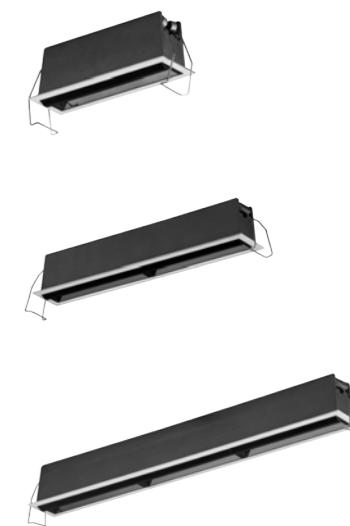
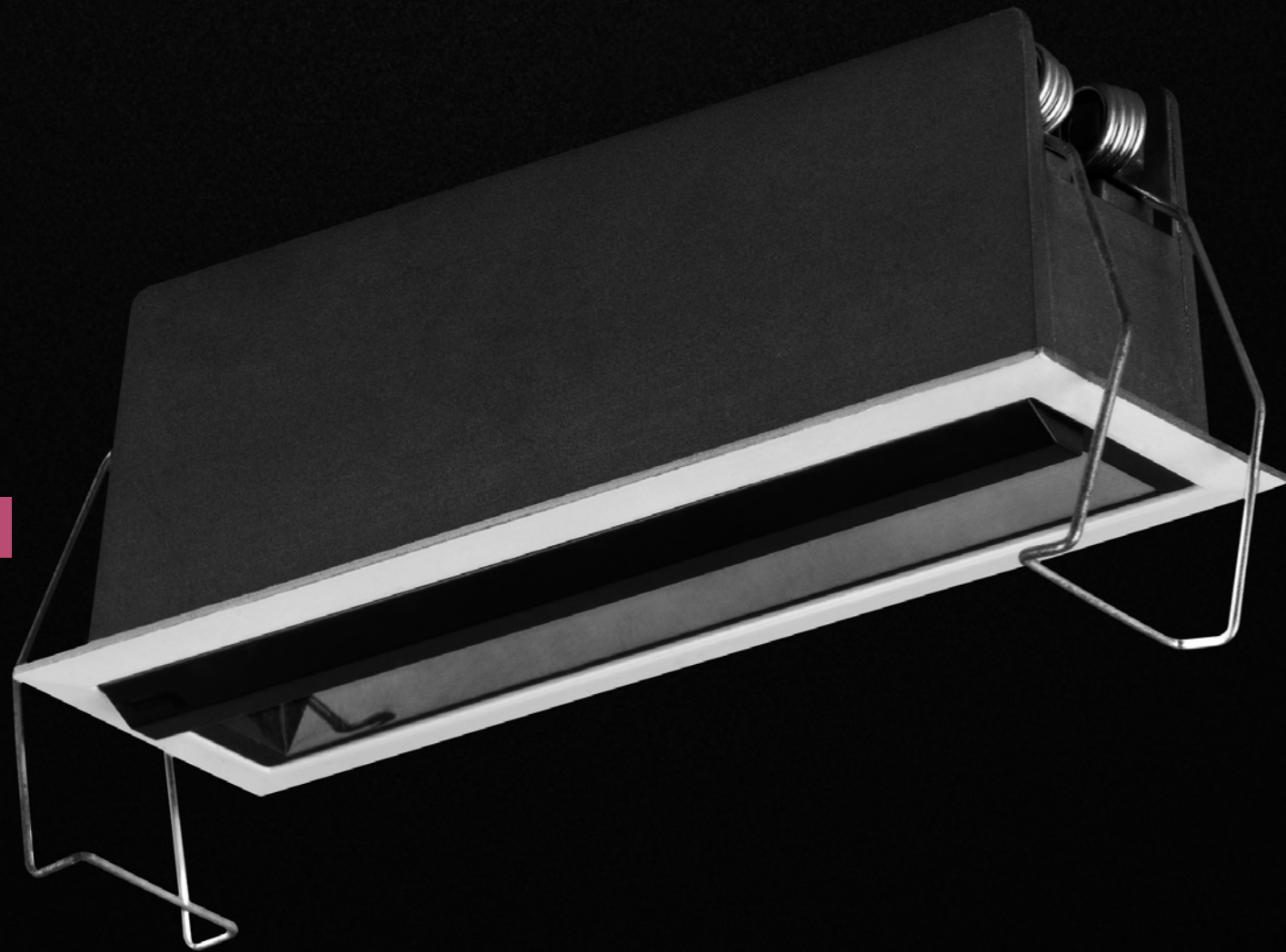

#### PRODUCT DATA 产品参数

Model 型号	Light Source 光源	Power/CCT 功率 / 色温	Light Output 光通量	Light Efficiency 光效率	Size(WxLxH) 尺寸	Cutout 开孔尺寸
IG-GSB14710 02 ①	SMD	10W/3000K	≥460 lm	≥37 lm/W	147x45x79mm	140x37mm
IG-GSB14720 02 ②	SMD	20W/3000K	≥855 lm	≥43 lm/W	280x45x49mm	273x37mm
IG-GSB14730 02 ③	SMD	30W/3000K	≥1174 lm	≥41 lm/W	412.7x45x49mm	405x37mm

可定制  
调光方式:



#### PHOTOMETRIC 配光参数

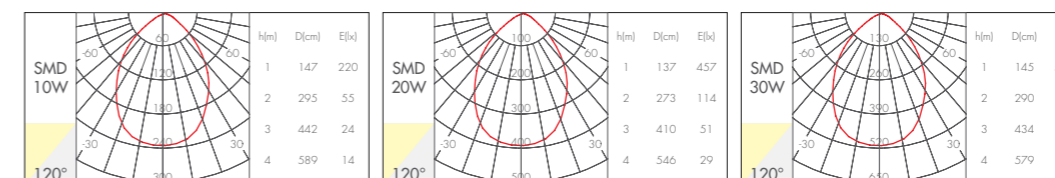



**PRODUCT DATA** 产品参数

Model 型号	Light Source 光源	Input voltage 输入电压	Power 功率	Light Output 光通量	length 长度
IG-XQ110024 01	BRIDGELUX / SANAN	DC 24V	24W/M	1920 lm/810 lm/300 lm	1M/0.5M/0.16M



**PRODUCT DATA** 产品参数

Model 型号	Light Source 光源	Input voltage 输入电压	Power 功率	Light Output 光通量	length 长度
IG-XQ110024 02	BRIDGELUX / SANAN	DC 24V	24W/M	1920 lm/810 lm/300 lm	1M/0.5M/0.16M

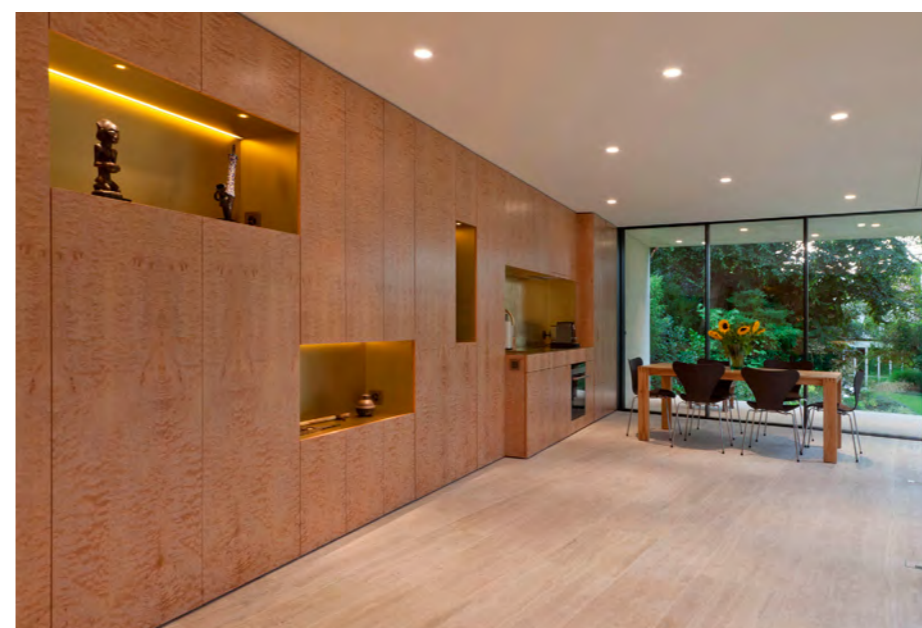



CRI>90
UGR <19
No flickering
3000K
4000K
15°
30°
45°
WH
BL
45°
IP20
30PCS

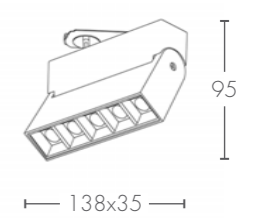

**PRODUCT DATA** 产品参数

Model 型号	Light Source 光源	Power/CCT 功率 / 色温	Light Output 光通量	Light Efficiency 光效率	Size(WxLxH) 尺寸	Installation 安装方式
IG-DG013812 01	SMD	12W/3000K	≥612 lm	≥58 lm/W	138x35x95mm	2线 / 3线

可定制  
 调光方式: 0/1-10v Triac DALI DALI 2  
 DALI Dimming

**PHOTOMETRIC** 配光参数

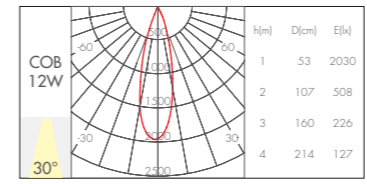



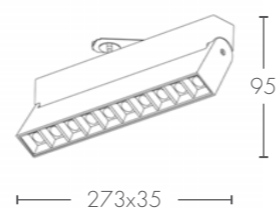

**PRODUCT DATA** 产品参数

Model 型号	Light Source 光源	Power/CCT 功率 / 色温	Light Output 光通量	Light Efficiency 光效率	Size(WxLxH) 尺寸	Installation 安装方式
IG-DG013820 01	SMD	20W/3000K	≥1172 lm	≥60 lm/W	273x35x95mm	2 线 / 3 线



**PHOTOMETRIC** 配光参数

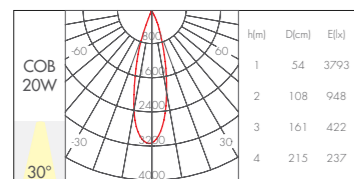



- CRI>90
- UGR <19
- No flickering
- 3000K
- 4000K
- CCT Dimmable
- 15°
- 24°
- 36°
- BL
- IP20
- 18PCS

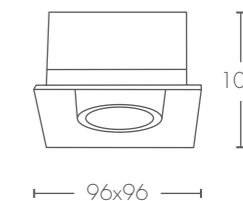

**PRODUCT DATA** 产品参数

Model 型号	Light Source 光源	Power/CCT 功率 / 色温	Light Output 光通量	Light Efficiency 光效率	Size(WxLxH) 尺寸	Cutout 开孔尺寸
IG-GS109608 01	COB	8W/3000K	≥520 lm	≥65 lm/W	96x96x103mm	96x96mm
IG-GS109612 01	COB	12W/3000K	≥780 lm	≥65 lm/W	96x96x103mm	96x96mm

可定制  
调光方式:



**PHOTOMETRIC** 配光参数

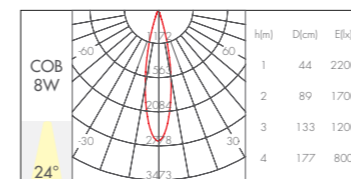

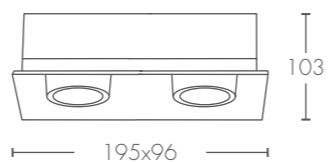

**PRODUCT DATA** 产品参数

Model 型号	Light Source 光源	Power/CCT 功率 / 色温	Light Output 光通量	Light Efficiency 光效率	Size(WxLxH) 尺寸	Cutout 开孔尺寸
IG-GS109616 02	COB	2x8W/3000K	≥1040 lm	≥65 lm/W	195x96x103mm	195x96mm
IG-GS109624 02	COB	2x12W/3000K	≥1560 lm	≥65 lm/W	195x96x103mm	195x96mm



**PHOTOMETRIC** 配光参数

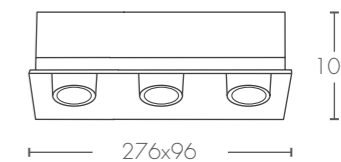
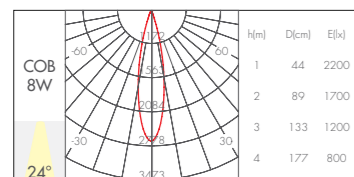

**PRODUCT DATA** 产品参数

Model 型号	Light Source 光源	Power/CCT 功率 / 色温	Light Output 光通量	Light Efficiency 光效率	Size(WxLxH) 尺寸	Cutout 开孔尺寸
IG-GS109624 03	COB	3x8W/3000K	≥1560 lm	≥65 lm/W	276x96x103mm	276x96mm
IG-GS109636 03	COB	3x12W/3000K	≥2340 lm	≥65 lm/W	276x96x103mm	276x96mm

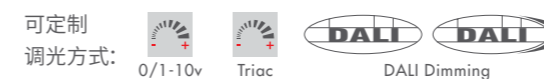

**PHOTOMETRIC** 配光参数

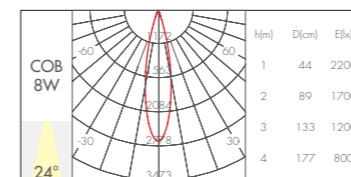

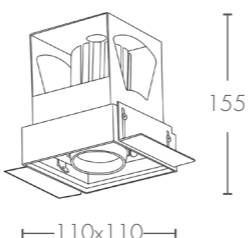
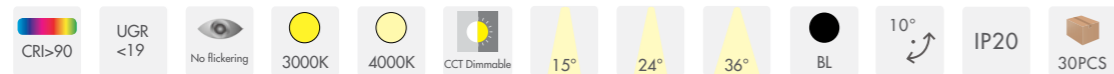

**PRODUCT DATA** 产品参数

Model 型号	Light Source 光源	Power/CCT 功率 / 色温	Light Output 光通量	Light Efficiency 光效率	Size(WxLxH) 尺寸	Cutout 开孔尺寸
IG-GS012520 01	COB	20W/3000K	≥839 lm	≥59 lm/W	110x110x155mm	125x125mm



**PHOTOMETRIC** 配光参数

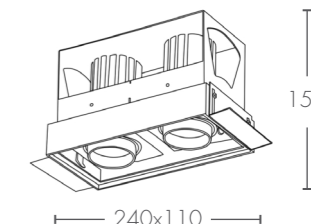
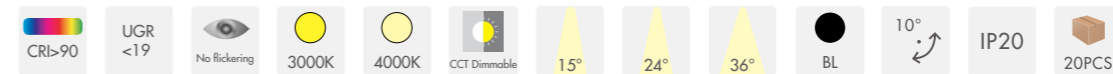
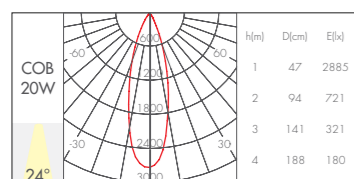

**PRODUCT DATA** 产品参数

Model 型号	Light Source 光源	Power/CCT 功率 / 色温	Light Output 光通量	Light Efficiency 光效率	Size(WxLxH) 尺寸	Cutout 开孔尺寸
IG-GS025540 02	COB	2x20W/3000K	≥2x839 lm	≥59 lm/W	240x110x155mm	255x125mm

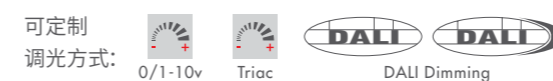

**PHOTOMETRIC** 配光参数

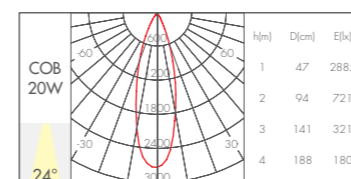

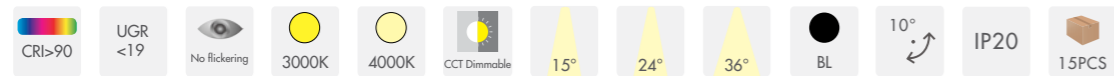

**PRODUCT DATA** 产品参数

Model 型号	Light Source 光源	Power/CCT 功率 / 色温	Light Output 光通量	Light Efficiency 光效率	Size(WxLxH) 尺寸	Cutout 开孔尺寸
IG-GS037560 03	COB	3x20W/3000K	≥3x839 lm	≥59 lm/W	360x110x155mm	380x125mm



**PHOTOMETRIC** 配光参数

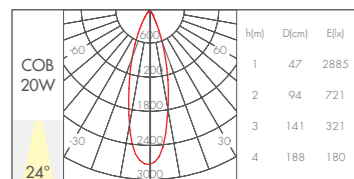



- CRI>90
- UGR <16
- No flickering
- 3000K
- 4000K
- 15°
- 30°
- 45°
- VH
- BL\*
- IP20
- 60PCS

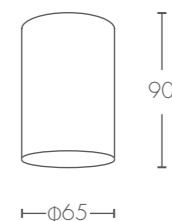

#### PRODUCT DATA 产品参数

Model 型号	Light Source 光源	Power/CCT 功率 / 色温	Light Output 光通量	Light Efficiency 光效率	Size(DxH) 尺寸	Installation 安装方式
IG-MS106508 01	COB	8W/3000K	≥480 lm	≥60 lm/W	Φ65x90mm	吸顶式

#### PHOTOMETRIC 配光参数

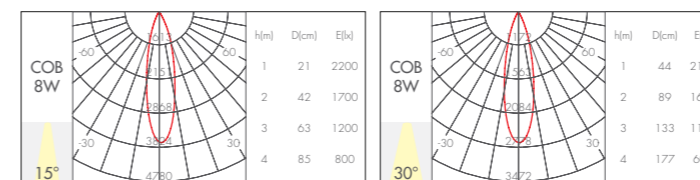

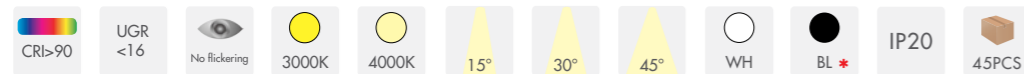

**PRODUCT DATA** 产品参数

Model 型号	Light Source 光源	Power/CCT 功率 / 色温	Light Output 光通量	Light Efficiency 光效率	Size(DxH) 尺寸	Installation 安装方式
IG-MS109115 01	COB	15W/3000K	≥900 lm	≥60 lm/W	Φ91x120mm	吸顶式

**PHOTOMETRIC** 配光参数

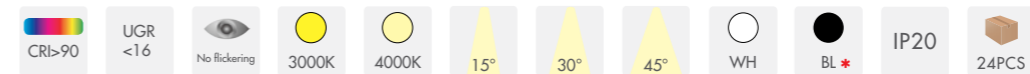
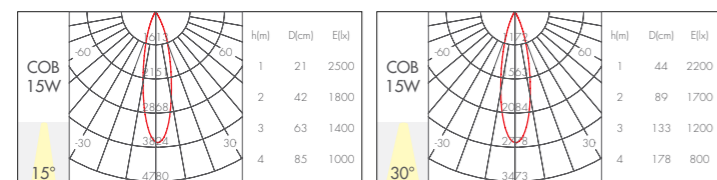

**PRODUCT DATA** 产品参数

Model 型号	Light Source 光源	Power/CCT 功率 / 色温	Light Output 光通量	Light Efficiency 光效率	Size(DxH) 尺寸	Installation 安装方式
IG-MS111520 01	COB	20W/3000K	≥1200 lm	≥60 lm/W	Φ115x150mm	吸顶式

**PHOTOMETRIC** 配光参数

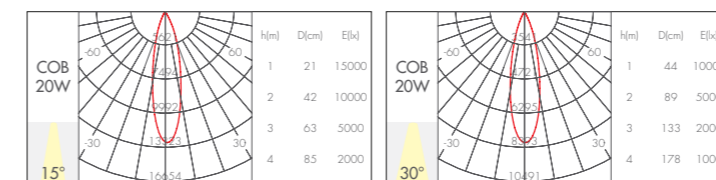

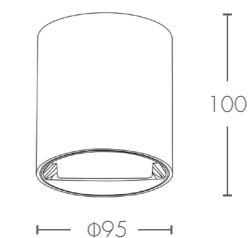

### PRODUCT DATA 产品参数

Model 型号	Light Source 光源	Power/CCT 功率 / 色温	Light Output 光通量	Light Efficiency 光效率	Size(DxH) 尺寸	Installation 安装方式
IG-MS009620 01	COB	20W/3000K	≥960 lm	≥48 lm/W	Φ95x100mm	吸顶式
IG-MS009625 01	COB	25W/3000K	≥1154 lm	≥48 lm/W	Φ95x100mm	吸顶式

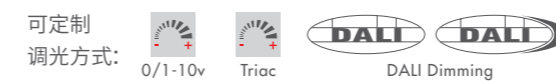

### PHOTOMETRIC 配光参数

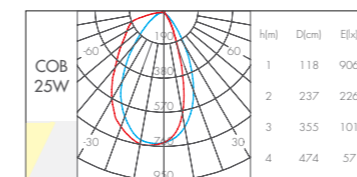



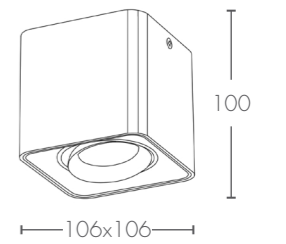
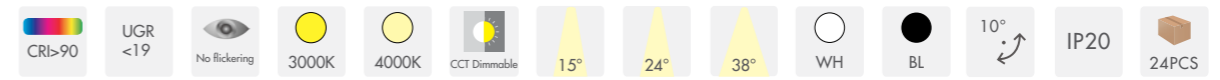

**PRODUCT DATA** 产品参数

Model 型号	Light Source 光源	Power/CCT 功率 / 色温	Light Output 光通量	Light Efficiency 光效率	Size(WxLxH) 尺寸	Installation 安装方式
IG-MS010610 01	COB	10W/3000K	≥715 lm	≥68 lm/W	106x106x100mm	吸顶式

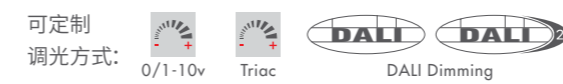

**PHOTOMETRIC** 配光参数

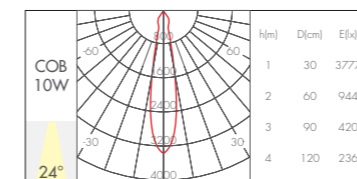

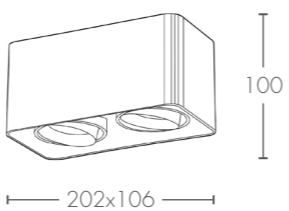
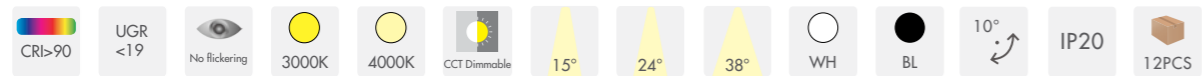

**PRODUCT DATA** 产品参数

Model 型号	Light Source 光源	Power/CCT 功率 / 色温	Light Output 光通量	Light Efficiency 光效率	Size(WxLxH) 尺寸	Installation 安装方式
IG-MS021020 01	COB	2x10W/3000K	≥1398 lm	≥71 lm/W	202x106x100mm	吸顶式



**PHOTOMETRIC** 配光参数

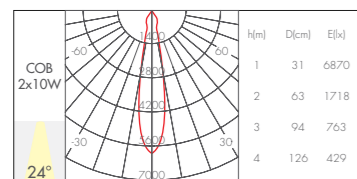



**PRODUCT DATA** 产品参数

Model 型号	Light Source 光源	Power/CCT 功率 / 色温	Light Output 光通量	Light Efficiency 光效率	Size(DxH) 尺寸	Cutout 开孔尺寸
IG-TD107507 02	SMD	7W/6500K	≥560 lm	≥80 lm/W	Φ90x58mm	Φ75mm

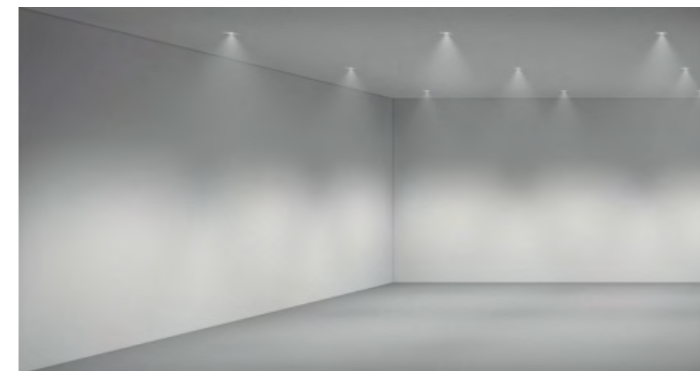



**PRODUCT DATA** 产品参数

Model 型号	Light Source 光源	Power/CCT 功率 / 色温	Light Output 光通量	Light Efficiency 光效率	Size(DxH) 尺寸	Cutout 开孔尺寸
IG-TD109512 03	SMD	12W/3000K	≥960 lm	≥80 lm/W	Φ102x68mm	Φ95mm

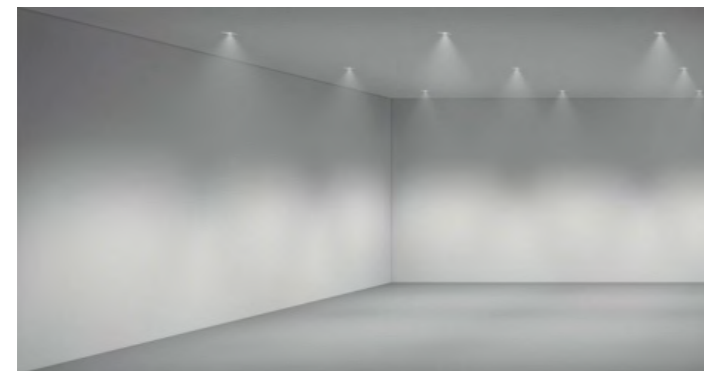

**PRODUCT DATA** 产品参数

Model 型号	Light Source 光源	Power/CCT 功率 / 色温	Light Output 光通量	Light Efficiency 光效率	Size(DxH) 尺寸	Cutout 开孔尺寸
IG-TD112518 04	SMD	18W/3000K	≥1170 lm	≥65 lm/W	Φ140x68mm	Φ125mm

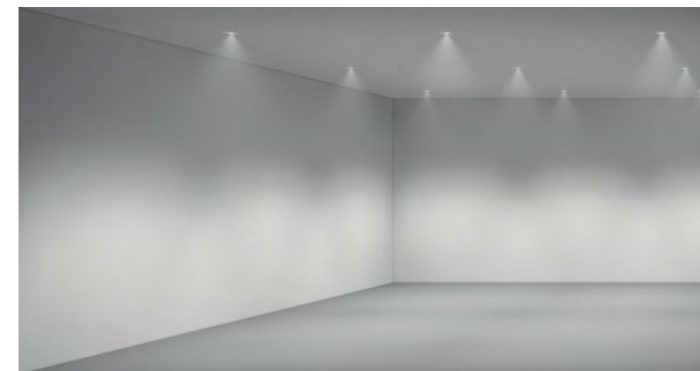



**PRODUCT DATA** 产品参数

Model 型号	Light Source 光源	Power/CCT 功率 / 色温	Light Output 光通量	Light Efficiency 光效率	Size(DxH) 尺寸	Cutout 开孔尺寸
IG-TD115025 05	SMD	25W/3000K	≥2000 lm	≥80 lm/W	Φ180x90mm	Φ150mm

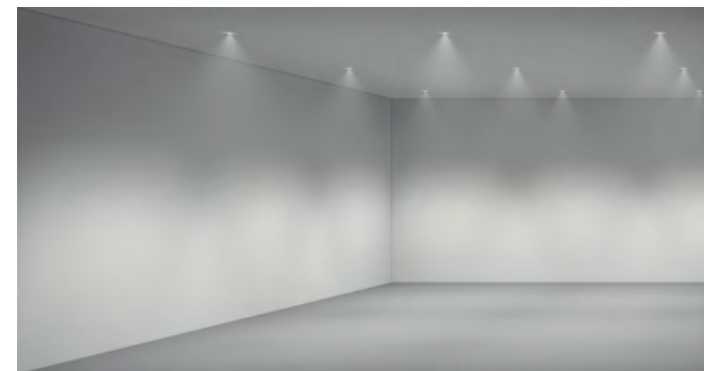

**PRODUCT DATA** 产品参数

Model 型号	Light Source 光源	Power/CCT 功率 / 色温	Light Output 光通量	Light Efficiency 光效率	Size(DxH) 尺寸	Cutout 开孔尺寸
IG-TD120535 08	SMD	35W/3000K	≥2800 lm	≥80 lm/W	Φ230x120mm	Φ205mm

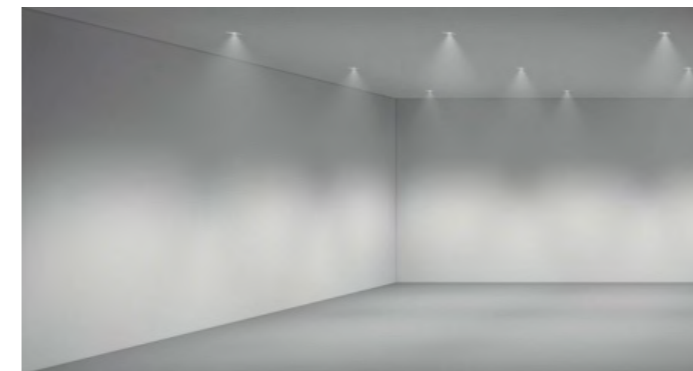



#### 市场应用:

店铺、星级酒店、高端别墅、会所、民宿、超市、商业综合体、展览及博物馆等

#### Applications:

Shops, star hotels, high-end villas, clubs, lodging houses, supermarkets, commercial complexes, exhibitions and museums, etc.

#### 产品特性描述:

1. 国际进口品牌光源, CRI > 80/90, 光效高、性能稳定, 光色一致性高;
2. 国标铝材灯体和冷锻散热器, 确保灯具良好外观成型及充分的散热;
3. 优异配光设计并使用国内著名反射器, 光晕自然舒适, 光形好, 峰值光强度高;
4. 内置隔离恒流驱动, 外观简洁、质量稳定;
5. 产品深防眩设计, 防眩角大于 35 度;
6. 系列化产品, 款款经典, 可满足不同场合使用要求;
7. 整灯寿命长达 30000 小时。

#### Product Features:

1. The international import brand light source, CRI > 80/90, has high luminous efficiency, stable performance and high consistency of light and color.
2. High quality aluminum heat sink to ensure ingenious shape and increase heat dissipation space.
3. Excellent precision optical design with high quality reflector, to realise a clear light shape and high peak intensity.
4. High quality isolated constant current driver. Dimming, intelligent control functions for option.
5. Deep anti glare design, anti glare angle greater than 35 degrees.
6. Serialized products, classic design, fit for different applications.
7. Lifespan up to 30,000 hours.

## 白金 PT

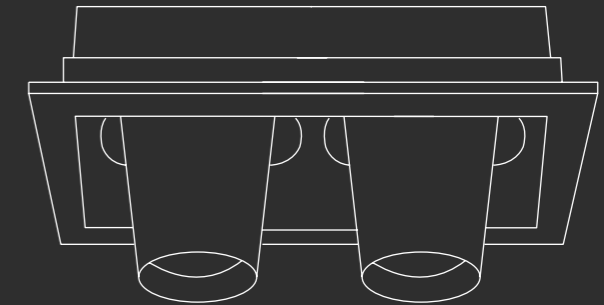
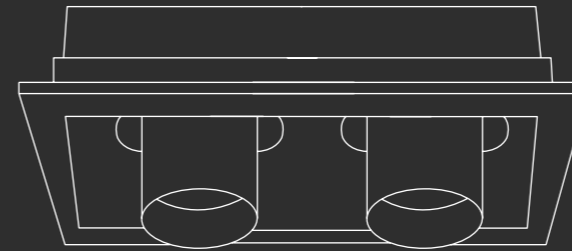

#### 嵌入式射灯

Recessed spotlight

Page. 228



8W/12W

2x8W/2x12W

8W

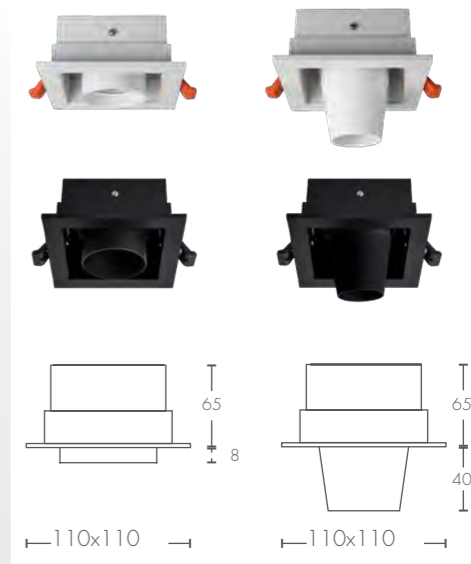
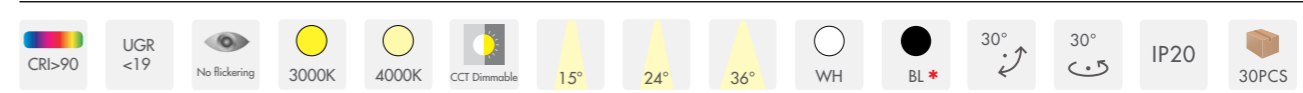

**PRODUCT DATA** 产品参数

Model 型号	Light Source 光源	Power/CCT 功率 / 色温	Light Output 光通量	Light Efficiency 光效率	Size(WxLxH) 尺寸	Cutout 开孔尺寸	Remarks 备注
IG-GS009408 01	COB	8W/3000K	≥520 lm	≥65 lm/W	110x110x65mm	95x95mm	直短筒
IG-GS009412 01	COB	*12W/3000K	≥890 lm	≥469 lm/W	110x110x65mm	95x95mm	直短筒



**PHOTOMETRIC** 配光参数

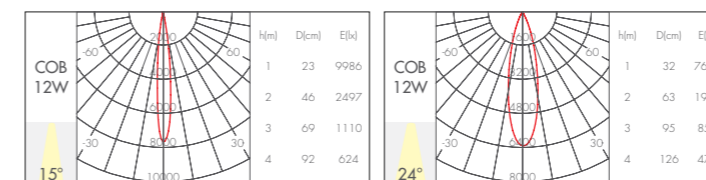

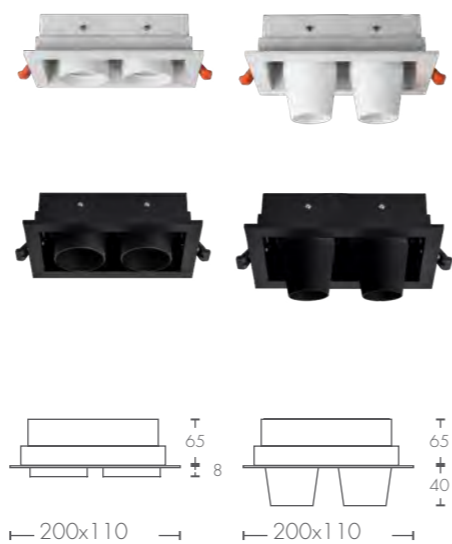
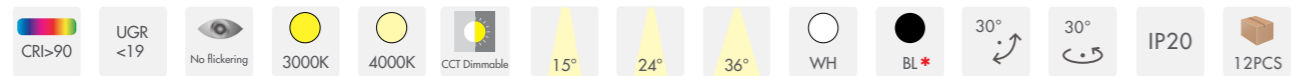

**PRODUCT DATA** 产品参数

Model 型号	Light Source 光源	Power/CCT 功率 / 色温	Light Output 光通量	Light Efficiency 光效率	Size(WxLxH) 尺寸	Cutout 开孔尺寸	Remarks 备注
IG-GS009416 01	COB	2x8W/3000K	≥2x520 lm	≥65 lm/W	200x110x65mm	185x95mm	直短筒
IG-GS009424 01	COB	* 2x12W/3000K	≥1638 lm	≥70 lm/W	200x110x65mm	185x95mm	直短筒



**PHOTOMETRIC** 配光参数

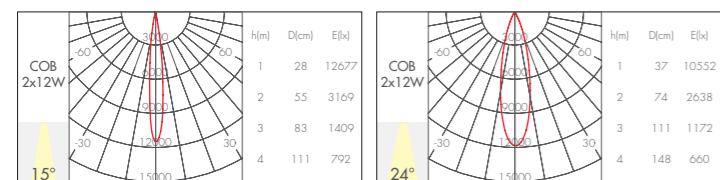





- CRI>90
- UGR <16
- No flickering
- 3000K
- 4000K
- CCT Dimmable
- 12°
- 15°
- 24°
- 36°
- WH
- BL
- 25°
- 350°
- IP20
- 30PCS

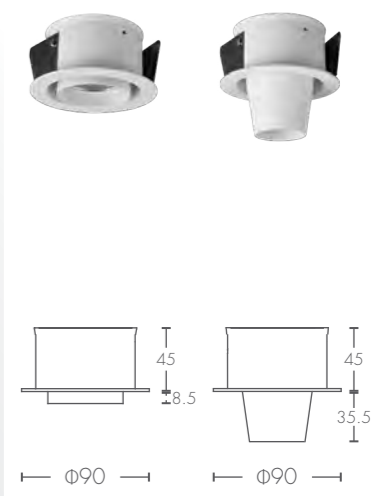

**PRODUCT DATA** 产品参数

Model 型号	Light Source 光源	Power/CCT 功率 / 色温	Light Output 光通量	Light Efficiency 光效率	Size(DxH) 尺寸	Cutout 开孔尺寸	Remarks 备注
IG-TH507508 01	COB	8W/3000K	≥637 lm	≥77 lm/W	Φ90x45mm	Φ75mm	直短筒

可定制  
调光方式: 0/1-10v Triac DALI Dimming

配件  
可选项: 直短筒 长斜筒  
出光效果 12°

**PHOTOMETRIC** 配光参数

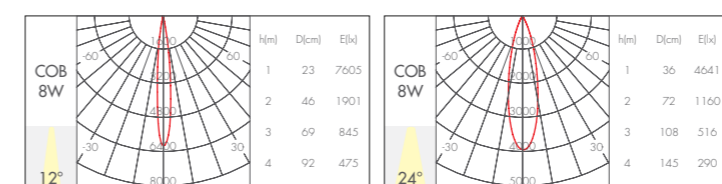



#### 市场应用:

店铺、星级酒店、高端别墅、会所、民宿、超市、商业综合体、展览及博物馆等

#### Applications:

Shops, star hotels, high-end villas, clubs, lodging houses, supermarkets, commercial complexes, exhibitions and museums, etc.

#### 产品特性描述:

1. 国际进口品牌光源, CRI > 80/90, 光效高、性能稳定, 光色一致性高;
2. 灯体全部采用航空铝材精加工而成, 确保灯具良好外观成型及充分的散热;
3. 优异配光设计并使用国内著名反射器, 光晕自然舒适, 光形好, 峰值光强度高;
4. 外置隔离恒流驱动, 外观简洁、质量稳定;
5. 产品深防眩设计, 防眩角大于 35 度;
6. 系列化产品, 款款经典, 可满足不同场合使用要求;
7. 整灯寿命长达 30000 小时。

#### Product Features:

1. The international import brand light source, CRI > 80/90, has high luminous efficiency, stable performance and high consistency of light and color.
2. The lamp body is all made of aviation aluminium, which ensures the good appearance, shaping and sufficient heat dissipation of the lamp.
3. Excellent precision optical design with high quality reflector, to realise a clear light shape and high peak intensity.
4. External Isolated Constant Current Drive, Simple Appearance, Stable Quality.
5. Deep anti glare design, anti glare angle greater than 35 degrees.
6. Serialized products, classic design, fit for different applications.
7. Lifespan up to 30,000 hours.

# AK75

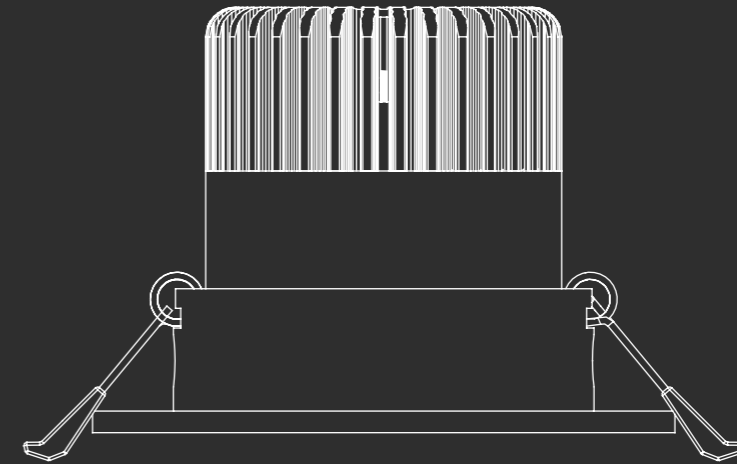

#### 天花灯

Ceiling spotlight

Page. 236



8W

8W

8W



- CRI>90
- UGR <19
- No flickering
- 2700K
- 3000K
- 4000K
- 15°
- 24°
- 36°
- WH
- BL
- IP20
- 45PCS

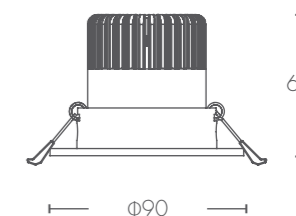

### PRODUCT DATA 产品参数

Model 型号	Light Source 光源	Power/CCT 功率 / 色温	Light Output 光通量	Light Efficiency 光效率	Size(DxH) 尺寸	Cutout 开孔尺寸
IG-TH207508 01	COB	8W/3000K	≥472 lm	≥56 lm/W	Φ90x65mm	Φ75mm

### PHOTOMETRIC 配光参数

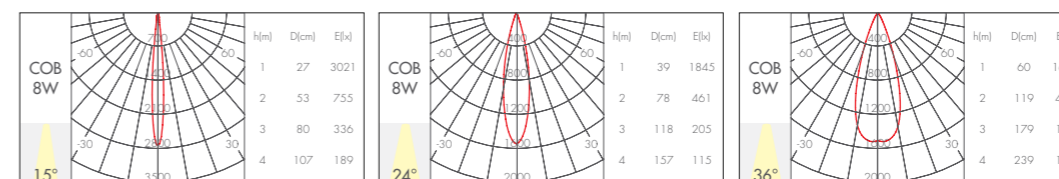

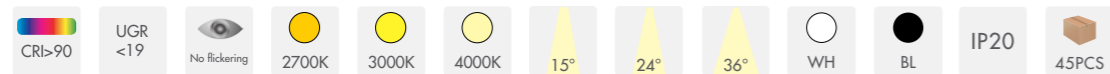

**PRODUCT DATA** 产品参数

Model 型号	Light Source 光源	Power/CCT 功率 / 色温	Light Output 光通量	Light Efficiency 光效率	Size(DxH) 尺寸	Cutout 开孔尺寸
IG-TH207508 03	COB	8W/3000K	≥409 lm	≥47 lm/W	Φ90x65mm	Φ75mm

**PHOTOMETRIC** 配光参数

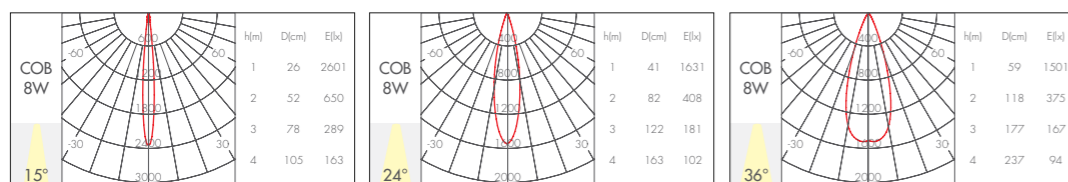

**PRODUCT DATA** 产品参数

Model 型号	Light Source 光源	Power/CCT 功率 / 色温	Light Output 光通量	Light Efficiency 光效率	Size(DxH) 尺寸	Cutout 开孔尺寸
IG-TH207508 04	COB	8W/3000K	≥369 lm	≥41 lm/W	Φ90x65mm	Φ75mm

**PHOTOMETRIC** 配光参数

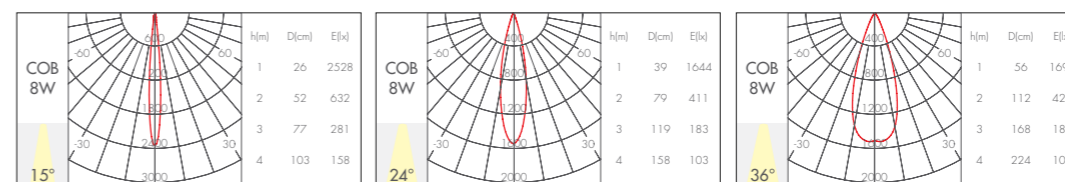



#### 市场应用:

店铺、星级酒店、高端别墅、会所、民宿、超市、商业综合体、展览及博物馆等

#### Applications:

Shops, star hotels, high-end villas, clubs, lodging houses, supermarkets, commercial complexes, exhibitions and museums, etc.

#### 产品特性描述:

1. 国际进口品牌光源, CRI > 80/90, 光效高、性能稳定, 光色一致性高;
2. 国标铝材灯体和冷锻散热器, 确保灯具良好外观成型及充分的散热;
3. 优异配光设计并使用国内著名反射器, 光晕自然舒适, 光形好, 峰值光强度高;
4. 内置隔离恒流驱动, 外观简洁、质量稳定;
5. 产品深防眩设计, 防眩角大于 35 度;
6. 系列化产品, 款款经典, 可满足不同场合使用要求;
7. 整灯寿命长达 30000 小时。

#### Product Features:

1. The international import brand light source, CRI > 80/90, has high luminous efficiency, stable performance and high consistency of light and color.
2. High quality aluminum heat sink to ensure ingenious shape and increase heat dissipation space.
3. Excellent precision optical design with high quality reflector, to realise a clear light shape and high peak intensity.
4. High quality isolated constant current driver. Dimming, intelligent control functions for option.
5. Deep anti glare design, anti glare angle greater than 35 degrees.
6. Serialized products, classic design, fit for different applications.
7. Lifespan up to 30,000 hours.

## 微光 MINI

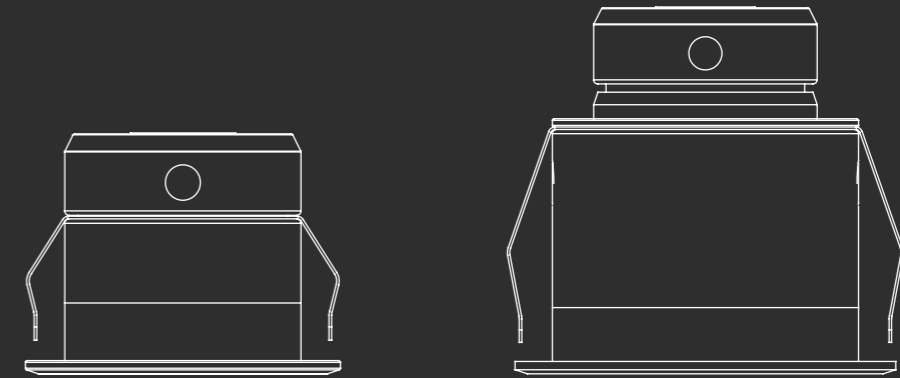

#### 天花灯

Ceiling spotlight

Page. 242

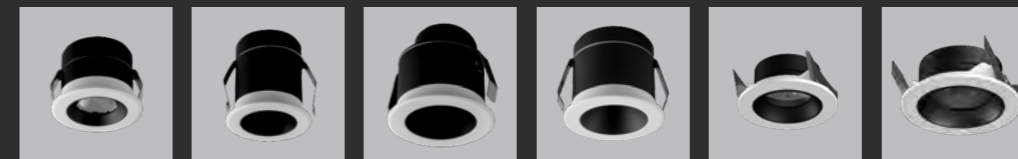

3W

3W

3W

3W

6W

8W



CRI>85
UGR <19
No flickering
2700K
3000K
4000K
10°
15°
24°
36°
BL
IP20
120PCS

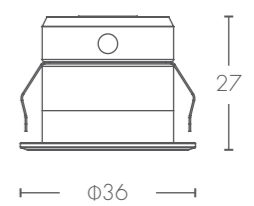

**PRODUCT DATA** 产品参数

Model 型号	Light Source 光源	Power/CCT 功率 / 色温	Light Output 光通量	Light Efficiency 光效率	Size(DxH) 尺寸	Cutout 开孔尺寸
IG-TH103003U 01	SMD	3W/3000K	≥135 lm	≥45 lm/W	Φ36x27mm	Φ30mm

配件   
 可选项: 三叉戟遮光片

**PHOTOMETRIC** 配光参数

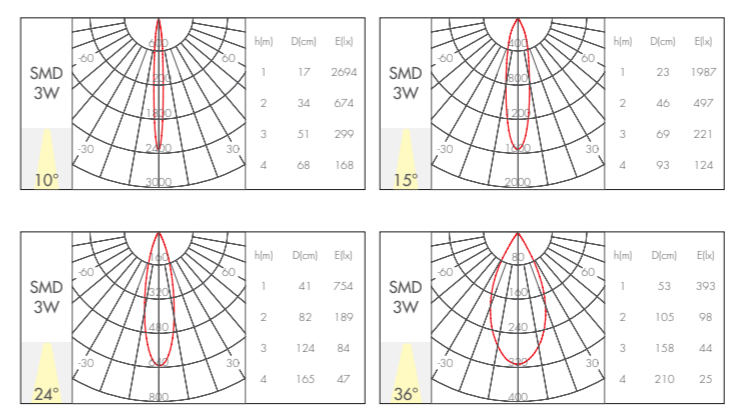

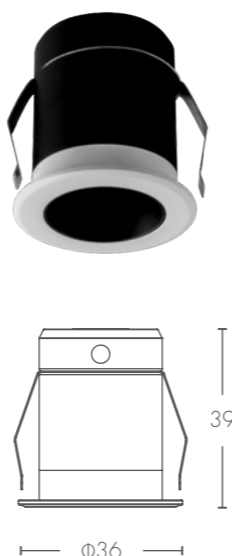
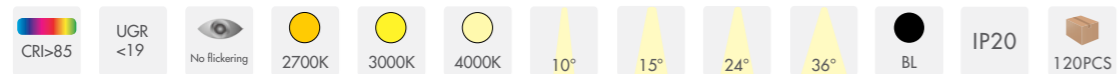

**PRODUCT DATA** 产品参数

Model 型号	Light Source 光源	Power/CCT 功率 / 色温	Light Output 光通量	Light Efficiency 光效率	Size(DxH) 尺寸	Cutout 开孔尺寸
IG-TH103003U 02	SMD	3W/3000K	≥110 lm	≥36 lm/W	Φ36x39mm	Φ30mm

**PHOTOMETRIC** 配光参数

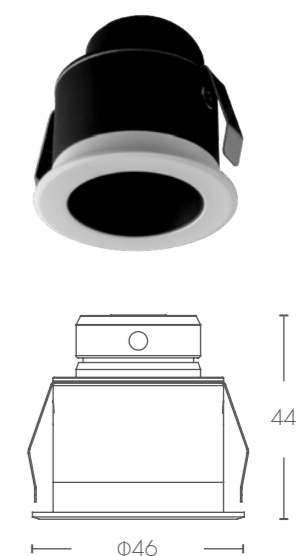
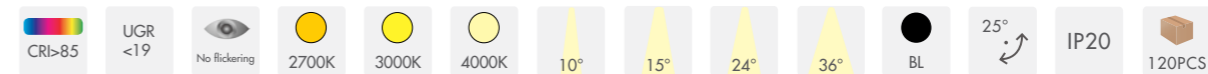
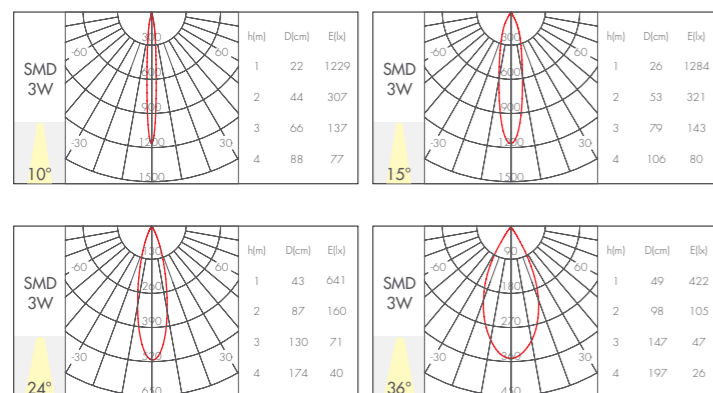

**PRODUCT DATA** 产品参数

Model 型号	Light Source 光源	Power/CCT 功率 / 色温	Light Output 光通量	Light Efficiency 光效率	Size(DxH) 尺寸	Cutout 开孔尺寸
IG-TH104003U 01	SMD	3W/3000K	≥110 lm	≥36 lm/W	Φ46x44mm	Φ40mm

**PHOTOMETRIC** 配光参数

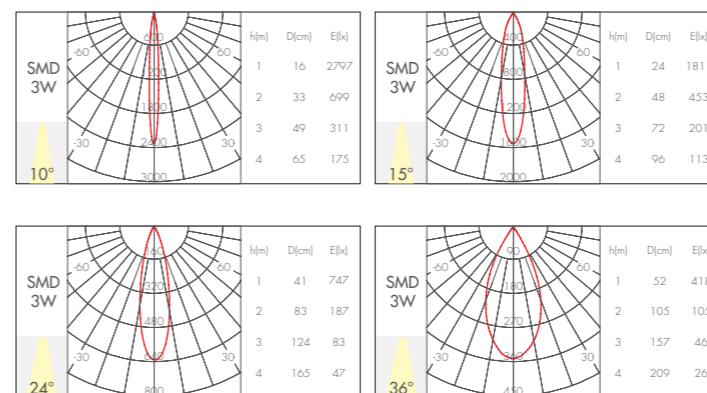

CRI>85
UGR <19
No flickering
2700K
3000K
4000K
10°
15°
24°
36°
BL
IP20
120PCS

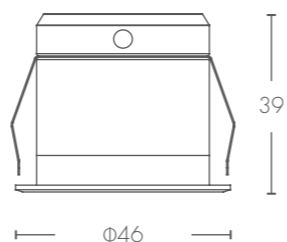

### PRODUCT DATA 产品参数

Model 型号	Light Source 光源	Power/CCT 功率 / 色温	Light Output 光通量	Light Efficiency 光效率	Size(DxH) 尺寸	Cutout 开孔尺寸
IG-TH104003U 02	SMD	3W/3000K	≥110 lm	≥36 lm/W	Φ46x39mm	Φ40mm

### PHOTOMETRIC 配光参数

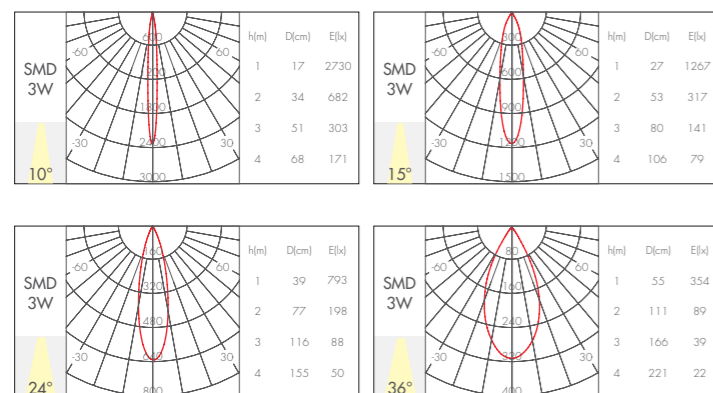



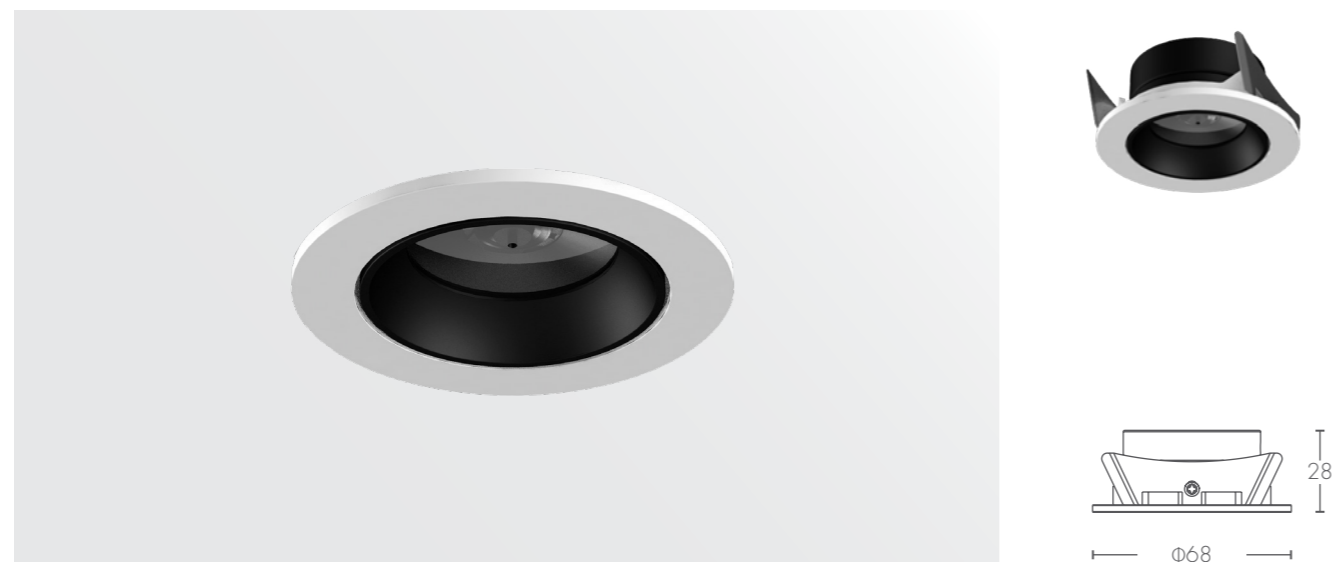

**PRODUCT DATA** 产品参数

Model 型号	Light Source 光源	Power/CCT 功率 / 色温	Light Output 光通量	Light Efficiency 光效率	Size(DxH) 尺寸	Cutout 开孔尺寸
IG-TH106006 01	COB	6W/3000K	≥400 lm	≥66 lm/W	Φ68x28mm	Φ60mm

配件  
可选项：  
 三叉戟遮光片

**PHOTOMETRIC** 配光参数

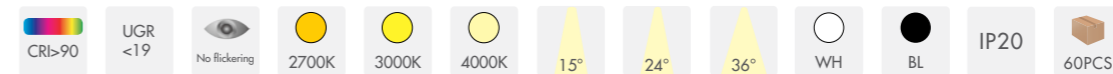
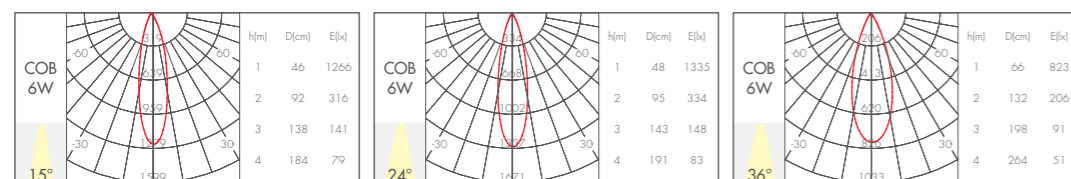

**PRODUCT DATA** 产品参数

Model 型号	Light Source 光源	Power/CCT 功率 / 色温	Light Output 光通量	Light Efficiency 光效率	Size(DxH) 尺寸	Cutout 开孔尺寸
IG-TH107508 01	COB	8W/3000K	≥550 lm	≥68 lm/W	Φ83x32.5mm	Φ75mm

配件  
可选项：  
 三叉戟遮光片

**PHOTOMETRIC** 配光参数

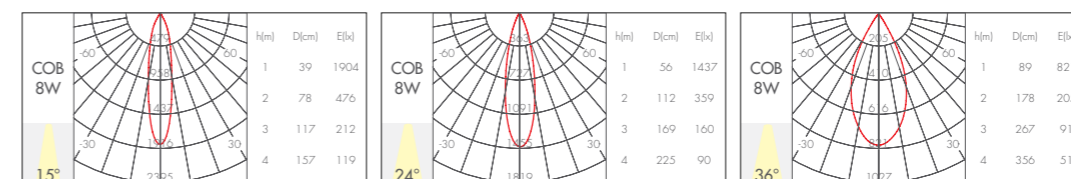



#### 市场应用:

店铺、星级酒店、高端别墅、会所、民宿、超市、商业综合体、展览及博物馆等

#### Applications:

Shops, star hotels, high-end villas, clubs, lodging houses, supermarkets, commercial complexes, exhibitions and museums, etc.

#### 产品特性描述:

1. 此系列产品有多种安装方式，可满足不同照明场所施工要求；
2. 产品简约，小巧精致，灯体长度最短可控制在 70mm 以内（内置驱动）；
3. 超高导热精密铝材散热，保证产品的使用寿命；
4. 产品运用深藏防眩设计，防眩角大于 45 度，只见光不见灯；
5. 灯头可垂直 90 度与水平 355 度任意调节，满足不同位置的照明需求；
6. 产品有多种光斑角度选择，如圆形光斑，矩形光斑；
7. 产品中心光强度高，光斑均匀，副光斑弱，且不明显。

#### Product Features:

1. This series of products has various installation methods to meet the construction requirements of different lighting places.
2. The product is compact, compact and exquisite. The shortest length of the lamp body can be controlled within 70mm (built-in drive).
3. High heat conduction precision aluminum heat dissipation, ensure product life.
4. The product is designed with a deep anti glare design, and the glare angle is greater than 45 degrees.
5. The lamp holder can be adjusted at 90 degrees and 355 degrees horizontally to meet the lighting needs of different locations.
6. The product has many kinds of spot angle selection, such as circular spot and rectangle spot.
7. The product center has high light intensity, uniform spot and weak spot.

## 劳特 ROUT

尺寸 size:  
Φ25mm

Page. 252



3W

3W

3W

3W

尺寸 size:  
Φ45mm

Page. 258



6W

6W

6W

6W

6W

尺寸 size:  
Φ60mm

Page. 266



8W/12W

8W/12W

8W/12W

8W/12W

8W/12W

尺寸 size:  
Φ73mm

Page. 274



20W/25W

20W/25W

20W/25W

20W/25W

20W/25W

尺寸 size:  
Φ85mm

Page. 282



30W/35W

SIZE:  $\Phi$ 25mm



#### 市场应用:

店铺、星级酒店、高端别墅、会所、民宿、超市、商业综合体、展览及博物馆等

#### Applications:

Shops, star hotels, high-end villas, clubs, lodging houses, supermarkets, commercial complexes, exhibitions and museums, etc.

#### 产品特性描述:

1. 此系列产品有多种安装方式，可满足不同照明场所施工要求；
2. 产品简约，小巧精致，灯体长度最短可控制在 70mm 以内（内置驱动）；
3. 超高导热精密铝材散热，保证产品的使用寿命；
4. 产品运用深藏防眩设计，防眩角大于 45 度，只见光不见灯；
5. 灯头可垂直 90 度与水平 355 度任意调节，满足不同位置的照明需求；
6. 产品有多种光斑角度选择，如圆形光斑，矩形光斑；
7. 产品中心光强度高，光斑均匀，副光斑弱，且不明显。

#### Product Features:

1. This series of products has various installation methods to meet the construction requirements of different lighting places.
2. The product is compact, compact and exquisite. The shortest length of the lamp body can be controlled within 70mm (built-in drive).
3. High heat conduction precision aluminum heat dissipation, ensure product life.
4. The product is designed with a deep anti glare design, and the glare angle is greater than 45 degrees.
5. The lamp holder can be adjusted at 90 degrees and 355 degrees horizontally to meet the lighting needs of different locations.
6. The product has many kinds of spot angle selection, such as circular spot and rectangle spot.
7. The product center has high light intensity, uniform spot and weak spot.

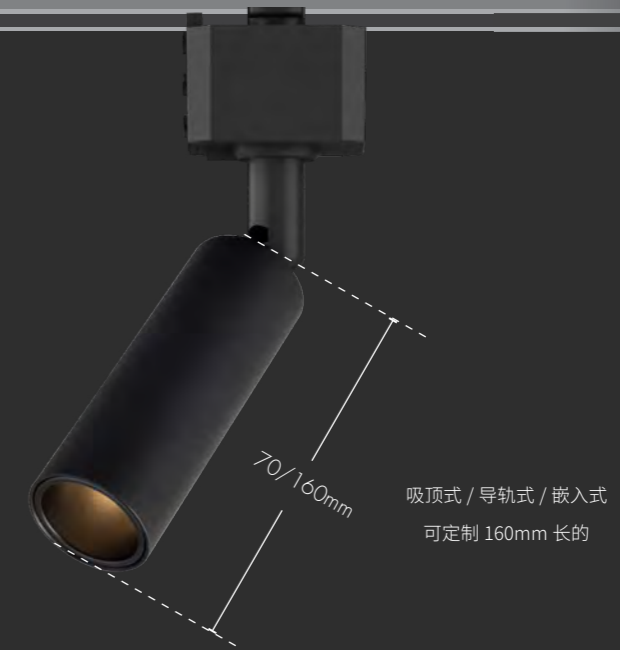

吸顶式



导轨式



嵌入式



吊线式

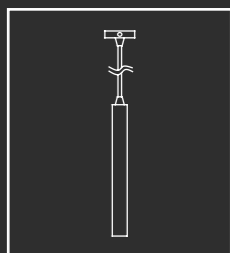
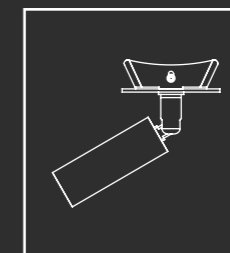
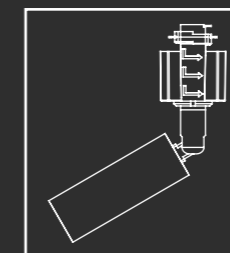
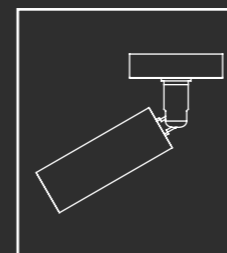

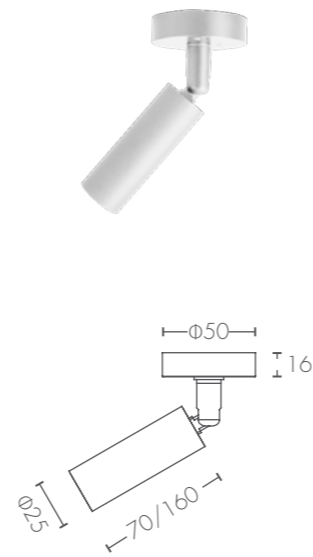
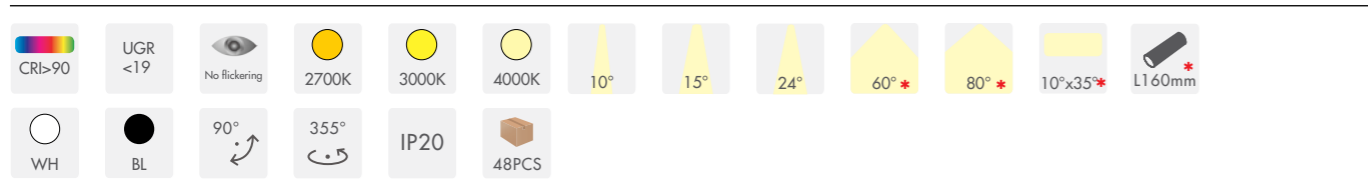

**PRODUCT DATA** 产品参数

Model 型号	Light Source 光源	Power/CCT 功率 / 色温	Light Output 光通量	Light Efficiency 光效率	Candela/Angle 中心光强 / 角度	Size(DxL) 尺寸	Installation 安装方式
IG-MS502503 04	SMD	3W/3000K	≥100 lm	≥33 lm/W	2000 cd/10°	Φ25x70mm Φ25x160mm*	吸顶式

Accurate light distribution and control

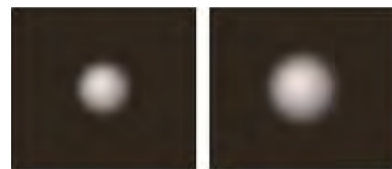

15°      24°

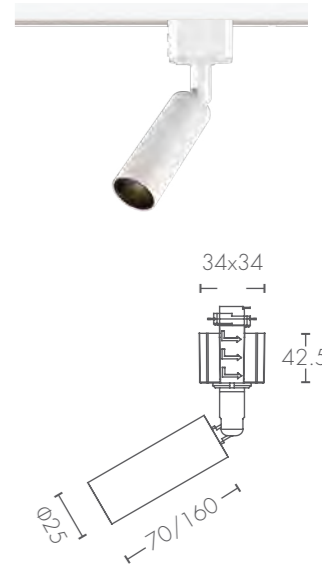
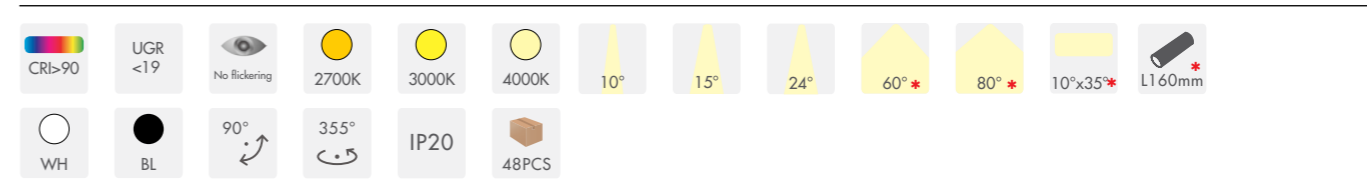

**PRODUCT DATA** 产品参数

Model 型号	Light Source 光源	Power/CCT 功率 / 色温	Light Output 光通量	Light Efficiency 光效率	Candela/Angle 中心光强 / 角度	Size(DxL) 尺寸	Installation 安装方式
IG-DG502503 01	SMD	3W/3000K	≥100 lm	≥33 lm/W	2000 cd/10°	Φ25x70mm Φ25x160mm*	2线 / 3线

Accurate light distribution and control

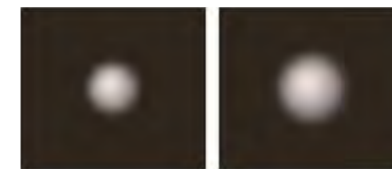

15°      24°

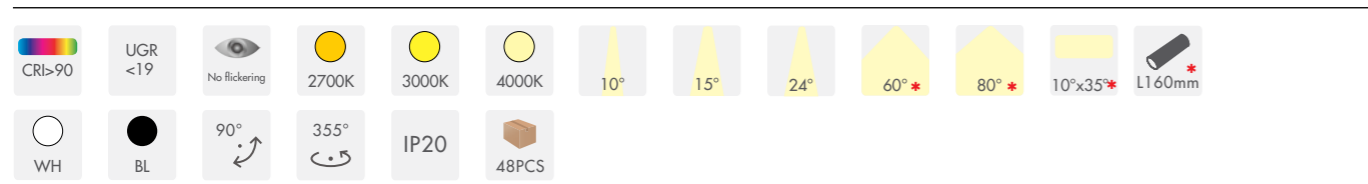

**PRODUCT DATA** 产品参数

Model 型号	Light Source 光源	Power/CCT 功率 / 色温	Light Output 光通量	Light Efficiency 光效率	Candela/Angle 中心光强 / 角度	Size(DxL) 尺寸	Cutout 开孔尺寸
IG-TH502503 03	SMD	3W/3000K	≥100 lm	≥33 lm/W	2000 cd/10°	Φ25x70mm Φ25x160mm*	Φ55mm

Accurate light distribution and control

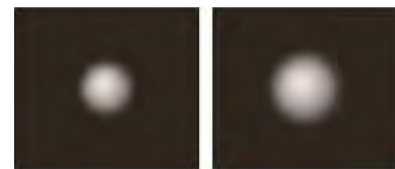

15°      24°

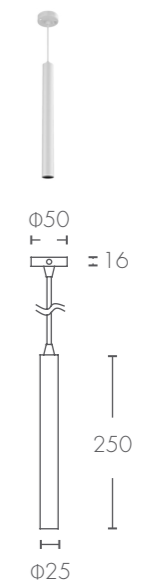
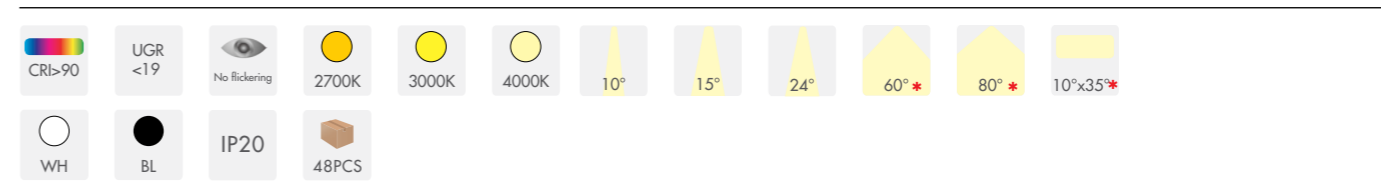

**PRODUCT DATA** 产品参数

Model 型号	Light Source 光源	Power/CCT 功率 / 色温	Light Output 光通量	Light Efficiency 光效率	Candela/Angle 中心光强 / 角度	Size(DxL) 尺寸	Installation 安装方式
IG-MS502503 05	SMD	3W/3000K	≥100 lm	≥33 lm/W	2000 cd/10°	Φ25x250mm	吊线式

Accurate light distribution and control

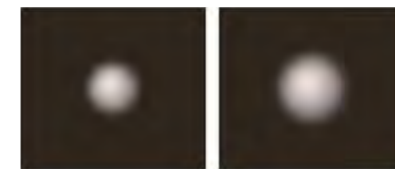

15°      24°

SIZE:  $\Phi$ 45mm



#### 市场应用:

店铺、星级酒店、高端别墅、会所、民宿、超市、商业综合体、展览及博物馆等

#### Applications:

Shops, star hotels, high-end villas, clubs, lodging houses, supermarkets, commercial complexes, exhibitions and museums, etc.

#### 产品特性描述:

1. 此系列产品有多种安装方式, 可满足不同照明场所施工要求;
2. 产品简约, 小巧精致, 灯体长度最短可控制在 70mm 以内 (内置驱动);
3. 超高导热精密铝材散热, 保证产品的使用寿命;
4. 产品运用深藏防眩设计, 防眩角大于 45 度, 只见光不见灯;
5. 灯头可垂直 90 度与水平 355 度任意调节, 满足不同位置的照明需求;
6. 产品有多种光斑角度选择, 如圆形光斑, 矩形光斑;
7. 产品中心光强度高, 光斑均匀, 副光斑弱, 且不明显。

#### Product Features:

1. This series of products has various installation methods to meet the construction requirements of different lighting places.
2. The product is compact, compact and exquisite. The shortest length of the lamp body can be controlled within 70mm (built-in drive).
3. High heat conduction precision aluminum heat dissipation, ensure product life.
4. The product is designed with a deep anti glare design, and the glare angle is greater than 45 degrees.
5. The lamp holder can be adjusted at 90 degrees and 355 degrees horizontally to meet the lighting needs of different locations.
6. The product has many kinds of spot angle selection, such as circular spot and rectangle spot.
7. The product center has high light intensity, uniform spot and weak spot.



吸顶式



导轨式



嵌入式



一体式



吊线式

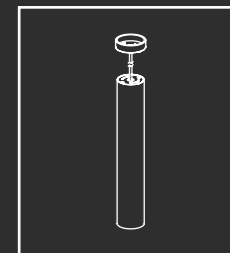
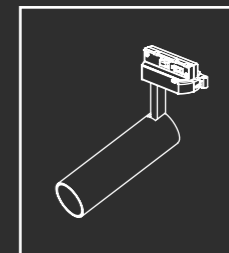
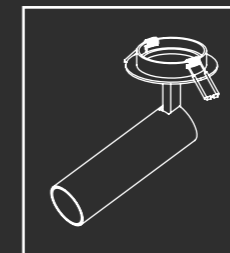
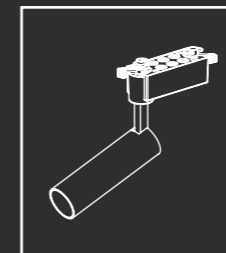
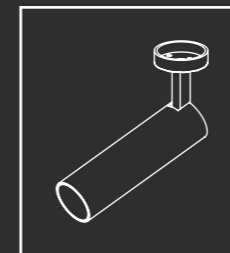



**PRODUCT DATA** 产品参数

Model 型号	Light Source 光源	Power/CCT 功率 / 色温	Light Output 光通量	Light Efficiency 光效率	Size(DxL) 尺寸	Installation 安装方式
IG-MS504506 04	COB	6W/3000K	≥408 lm	≥69 lm/W	Φ45x150mm Φ45x100mm*	吸顶式

配件  
可选项:  防眩蜂窝网片

**PHOTOMETRIC** 配光参数

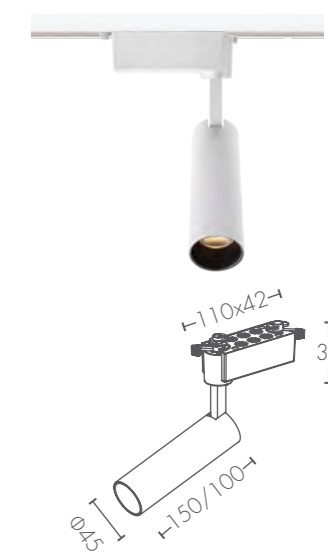
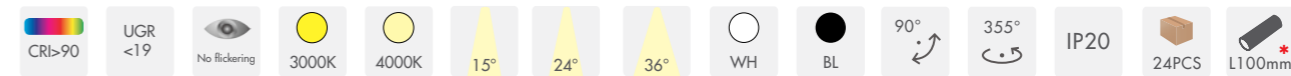
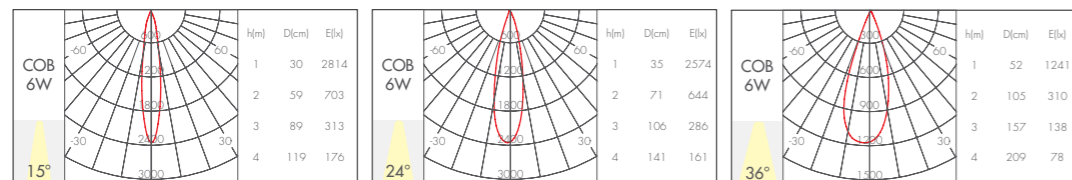

**PRODUCT DATA** 产品参数

Model 型号	Light Source 光源	Power/CCT 功率 / 色温	Light Output 光通量	Light Efficiency 光效率	Size(DxL) 尺寸	Installation 安装方式
IG-DG504506 02	COB	6W/3000K	≥408 lm	≥69 lm/W	Φ45x150mm Φ45x100mm*	2线/3线/4线

可定制  
调光方式:  Triac

配件  
可选项:  防眩蜂窝网片

**PHOTOMETRIC** 配光参数

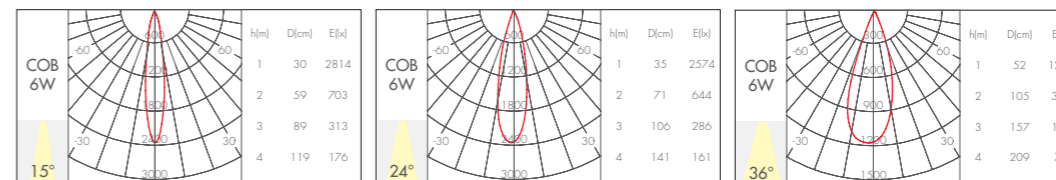

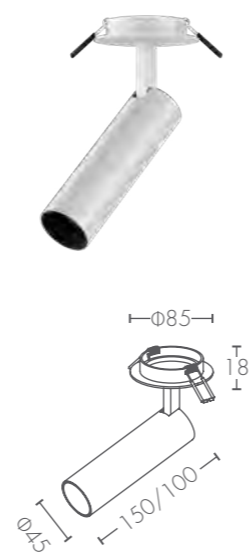
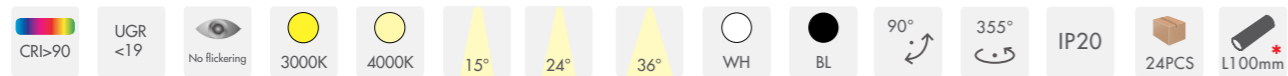

**PRODUCT DATA** 产品参数

Model 型号	Light Source 光源	Power/CCT 功率 / 色温	Light Output 光通量	Light Efficiency 光效率	Size(DxL) 尺寸	Cutout 开孔尺寸
IG-TH504506 03	COB	6W/3000K	≥408 lm	≥69 lm/W	Φ45x150mm Φ45x100mm*	Φ75mm



**PHOTOMETRIC** 配光参数

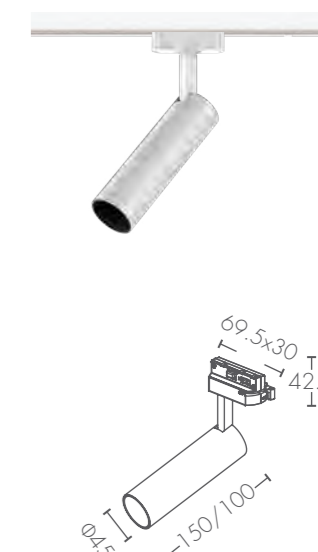
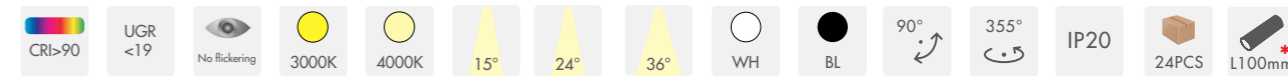
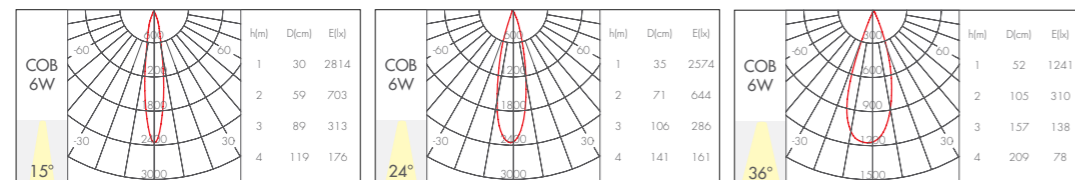

Model 型号	Light Source 光源	Power/CCT 功率 / 色温	Light Output 光通量	Light Efficiency 光效率	Size(DxL) 尺寸	Installation 安装方式
IG-DG504506 01	COB	6W/3000K	≥408 lm	≥69 lm/W	Φ45x150mm Φ45x100mm*	2线/3线/4线



**PHOTOMETRIC** 配光参数

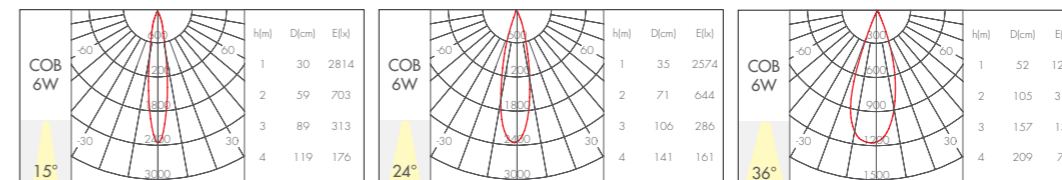



CRI>90
UGR <19
No flickering
3000K
4000K
15°
24°
36°
WH
BL
IP20
24PCS

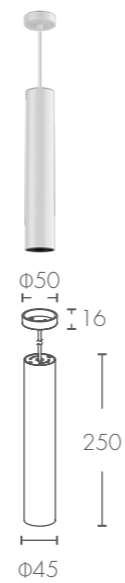

### PRODUCT DATA 产品参数

Model 型号	Light Source 光源	Power/CCT 功率 / 色温	Light Output 光通量	Light Efficiency 光效率	Size(DxL) 尺寸	Installation 安装方式
IG-MS504506 05	COB	6W/3000K	≥408 lm	≥69 lm/W	φ45x150mm	吊线式

配件  
 可选项:  防眩蜂窝网片

### PHOTOMETRIC 配光参数

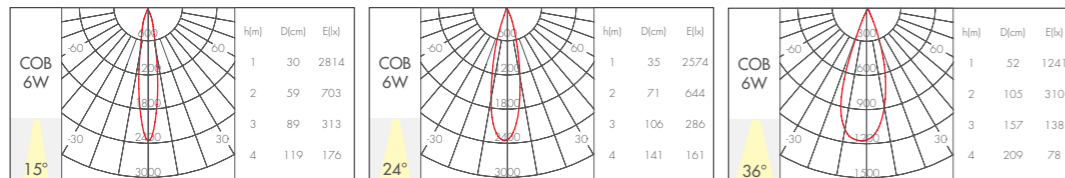

SIZE:  $\Phi$ 60mm



#### 市场应用:

店铺、星级酒店、高端别墅、会所、民宿、超市、商业综合体、展览及博物馆等

#### Applications:

Shops, star hotels, high-end villas, clubs, lodging houses, supermarkets, commercial complexes, exhibitions and museums, etc.

#### 产品特性描述:

1. 此系列产品有多种安装方式, 可满足不同照明场所施工要求;
2. 产品简约, 小巧精致, 灯体长度最短可控制在 70mm 以内 (内置驱动);
3. 超高导热精密铝材散热, 保证产品的使用寿命;
4. 产品运用深藏防眩设计, 防眩角大于 45 度, 只见光不见灯;
5. 灯头可垂直 90 度与水平 355 度任意调节, 满足不同位置的照明需求;
6. 产品有多种光斑角度选择, 如圆形光斑, 矩形光斑;
7. 产品中心光强度高, 光斑均匀, 副光斑弱, 且不明显。

#### Product Features:

1. This series of products has various installation methods to meet the construction requirements of different lighting places.
2. The product is compact, compact and exquisite. The shortest length of the lamp body can be controlled within 70mm (built-in drive).
3. High heat conduction precision aluminum heat dissipation, ensure product life.
4. The product is designed with a deep anti glare design, and the glare angle is greater than 45 degrees.
5. The lamp holder can be adjusted at 90 degrees and 355 degrees horizontally to meet the lighting needs of different locations.
6. The product has many kinds of spot angle selection, such as circular spot and rectangle spot.
7. The product center has high light intensity, uniform spot and weak spot.



吸顶式



导轨式



嵌入式



一体式



吊线式

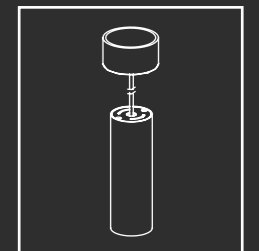
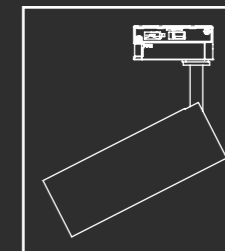
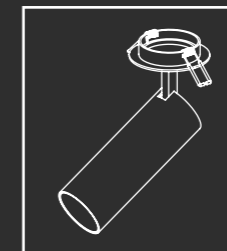
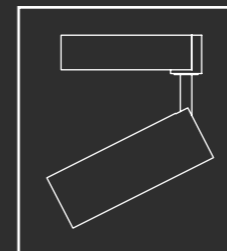
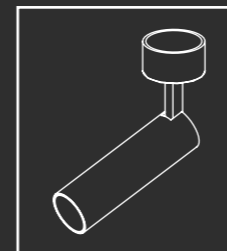
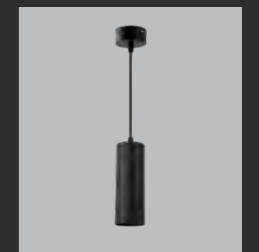

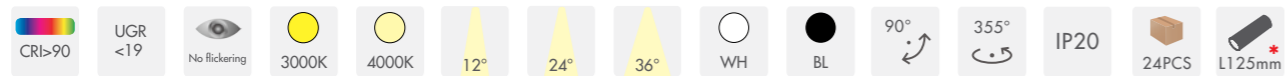

**PRODUCT DATA** 产品参数

Model 型号	Light Source 光源	Power/CCT 功率/色温	Light Output 光通量	Light Efficiency 光效率	Size(DxL) 尺寸	Installation 安装方式
IG-MS506008 04	COB	8W/3000K	≥520 lm	≥65 lm/W	Φ60x165mm Φ60x125mm *	吸顶式
IG-MS506012 04	COB	12W/3000K	≥780 lm	≥65 lm/W	Φ60x165mm Φ60x125mm *	吸顶式

配件  
可选项:  
防眩蜂窝网片

**PHOTOMETRIC** 配光参数

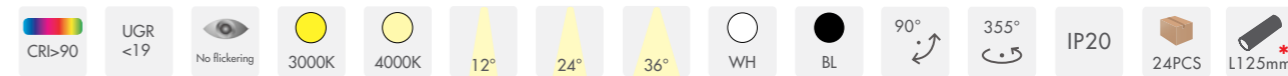
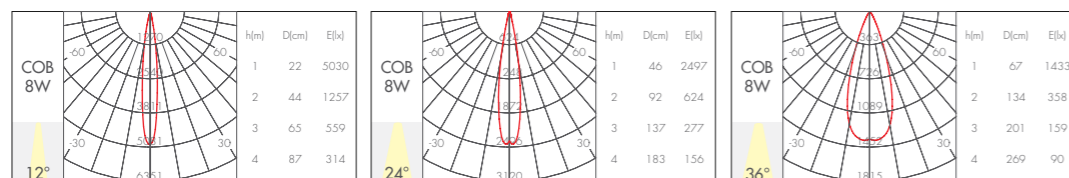

**PRODUCT DATA** 产品参数

Model 型号	Light Source 光源	Power/CCT 功率/色温	Light Output 光通量	Light Efficiency 光效率	Size(DxL) 尺寸	Installation 安装方式
IG-DG506008 02	COB	8W/3000K	≥520 lm	≥65 lm/W	Φ60x165mm Φ60x125mm *	2线/3线/4线
IG-DG506012 02	COB	12W/3000K	≥780 lm	≥65 lm/W	Φ60x165mm Φ60x125mm *	2线/3线/4线

可定制  
调光方式: 0/1-10v Triac

配件  
可选项:  
防眩蜂窝网片

**PHOTOMETRIC** 配光参数

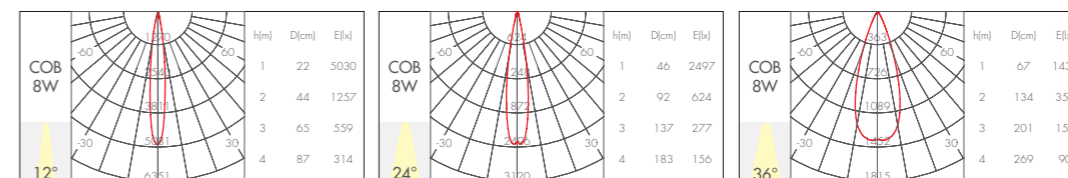

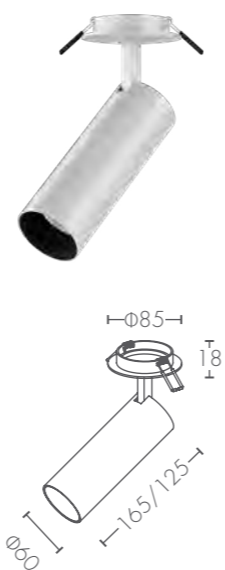

**PRODUCT DATA** 产品参数

Model 型号	Light Source 光源	Power/CCT 功率/色温	Light Output 光通量	Light Efficiency 光效率	Size(DxL) 尺寸	Installation 安装方式
IG-TH506008 03	COB	8W/3000K	≥520 lm	≥65 lm/W	Φ60x165mm Φ60x125mm *	Φ75mm
IG-TH506012 03	COB	12W/3000K	≥780 lm	≥65 lm/W	Φ60x165mm Φ60x125mm *	Φ75mm



**PHOTOMETRIC** 配光参数

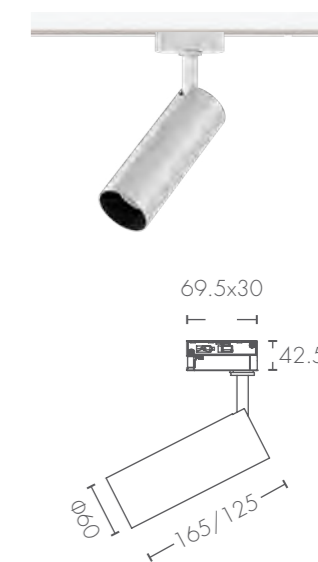
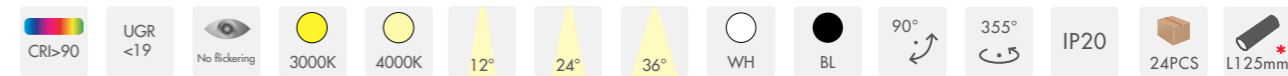
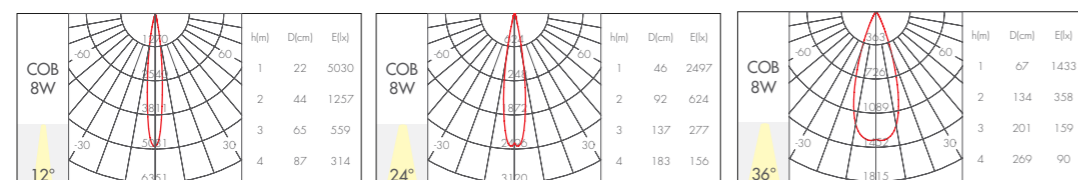

**PRODUCT DATA** 产品参数

Model 型号	Light Source 光源	Power/CCT 功率/色温	Light Output 光通量	Light Efficiency 光效率	Size(DxL) 尺寸	Installation 安装方式
IG-DG506008 01	COB	8W/3000K	≥520 lm	≥65 lm/W	Φ60x165mm Φ60x125mm *	2线/3线/4线
IG-DG506012 01	COB	12W/3000K	≥780 lm	≥65 lm/W	Φ60x165mm Φ60x125mm *	2线/3线/4线

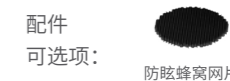
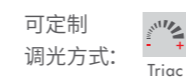

**PHOTOMETRIC** 配光参数

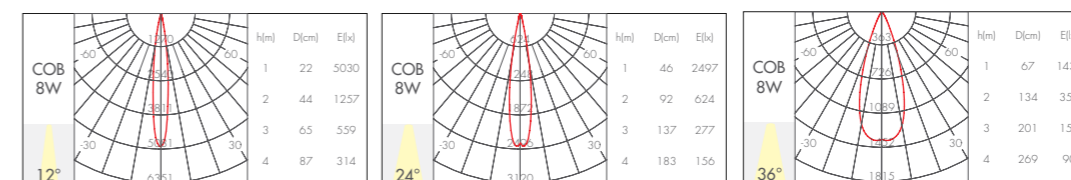

CRI>90
UGR <19
No flickering
3000K
4000K
12°
24°
36°
WH
BL
IP20
24PCS

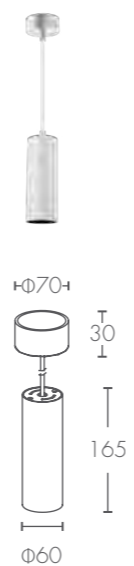

### PRODUCT DATA 产品参数

Model 型号	Light Source 光源	Power/CCT 功率 / 色温	Light Output 光通量	Light Efficiency 光效率	Size(DxL) 尺寸	Installation 安装方式
IG-MS506008 05	COB	8W/3000K	≥520 lm	≥65 lm/W	Φ60x165mm	吊线式
IG-MS506012 05	COB	12W/3000K	≥780 lm	≥65 lm/W	Φ60x165mm	吊线式

可定制  
调光方式: Triac

配件  
可选项: 防眩蜂窝网片

### PHOTOMETRIC 配光参数

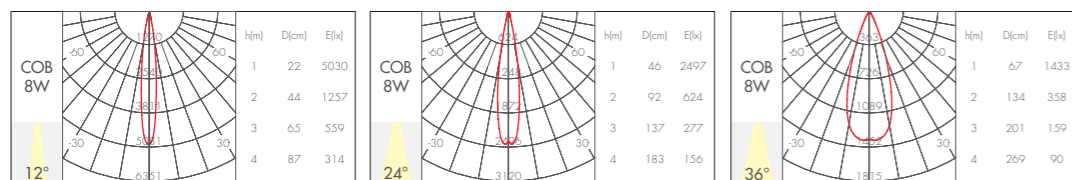

SIZE:  $\Phi 73\text{mm}$



#### 市场应用:

店铺、星级酒店、高端别墅、会所、民宿、超市、商业综合体、展览及博物馆等

#### Applications:

Shops, star hotels, high-end villas, clubs, lodging houses, supermarkets, commercial complexes, exhibitions and museums, etc.

#### 产品特性描述:

1. 此系列产品有多种安装方式，可满足不同照明场所施工要求；
2. 产品简约，小巧精致，灯体长度最短可控制在 70mm 以内（内置驱动）；
3. 超高导热精密铝材散热，保证产品的使用寿命；
4. 产品运用深藏防眩设计，防眩角大于 45 度，只见光不见灯；
5. 灯头可垂直 90 度与水平 355 度任意调节，满足不同位置的照明需求；
6. 产品有多种光斑角度选择，如圆形光斑，矩形光斑；
7. 产品中心光强度高，光斑均匀，副光斑弱，且不明显。

#### Product Features:

1. This series of products has various installation methods to meet the construction requirements of different lighting places.
2. The product is compact, compact and exquisite. The shortest length of the lamp body can be controlled within 70mm (built-in drive).
3. High heat conduction precision aluminum heat dissipation, ensure product life.
4. The product is designed with a deep anti glare design, and the glare angle is greater than 45 degrees.
5. The lamp holder can be adjusted at 90 degrees and 355 degrees horizontally to meet the lighting needs of different locations.
6. The product has many kinds of spot angle selection, such as circular spot and rectangle spot.
7. The product center has high light intensity, uniform spot and weak spot.



吸顶式



导轨式



嵌入式



一体式



吊线式

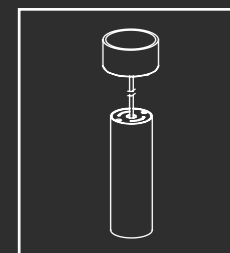
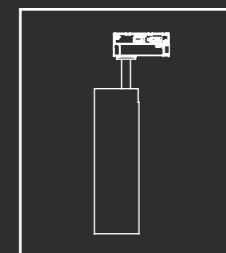
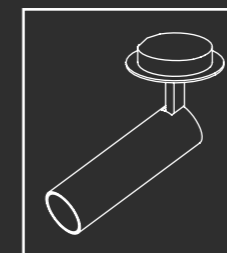
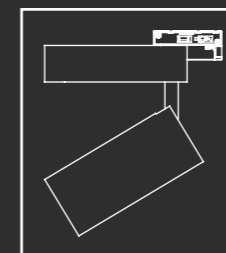
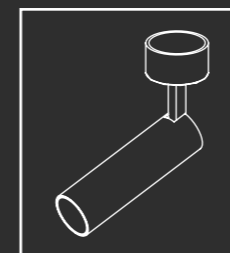

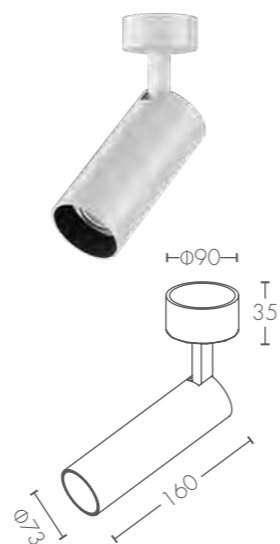

### PRODUCT DATA 产品参数

Model 型号	Light Source 光源	Power/CCT 功率 / 色温	Light Output 光通量	Light Efficiency 光效率	Size(DxL) 尺寸	Installation 安装方式
IG-MS507320 04	COB	20W/3000K	≥1200 lm	≥60 lm/W	Φ73x160mm	吸顶式
IG-MS507325 04	COB	25W/3000K	≥1500 lm	≥60 lm/W	Φ73x160mm	吸顶式

可定制  
调光方式: Triac

配件  
可选项: 防眩蜂窝网片

### PHOTOMETRIC 配光参数

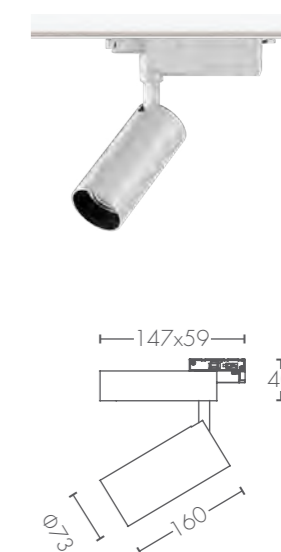
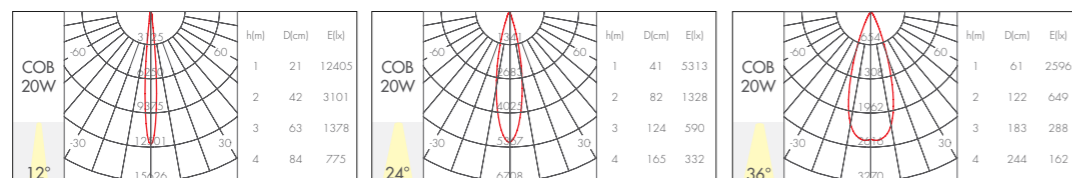

### PRODUCT DATA 产品参数

Model 型号	Light Source 光源	Power/CCT 功率 / 色温	Light Output 光通量	Light Efficiency 光效率	Size(DxL) 尺寸	Installation 安装方式
IG-DG507320 02	COB	20W/3000K	≥1200 lm	≥60 lm/W	Φ73x160mm	2线 / 3线 / 4线
IG-DG507325 02	COB	25W/3000K	≥1500 lm	≥60 lm/W	Φ73x160mm	2线 / 3线 / 4线

可定制  
调光方式: 0/1-10v Triac

配件  
可选项: 防眩蜂窝网片

### PHOTOMETRIC 配光参数

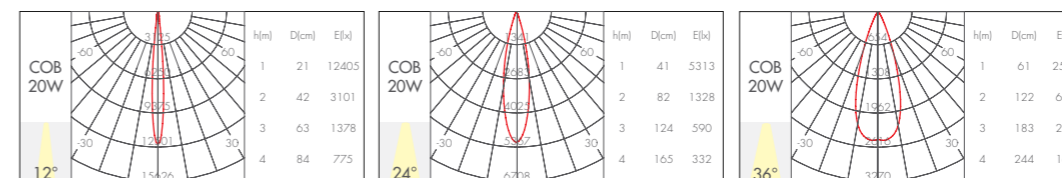

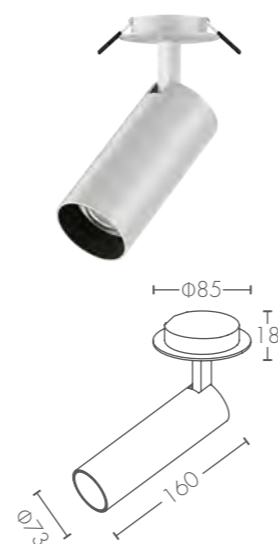

**PRODUCT DATA** 产品参数

Model 型号	Light Source 光源	Power/CCT 功率 / 色温	Light Output 光通量	Light Efficiency 光效率	Size(DxL) 尺寸	Installation 安装方式
IG-TH507320 03	COB	20W/3000K	≥1200 lm	≥60 lm/W	Φ73x160mm	Φ75mm
IG-TH507325 03	COB	25W/3000K	≥1500 lm	≥60 lm/W	Φ73x160mm	Φ75mm



**PHOTOMETRIC** 配光参数

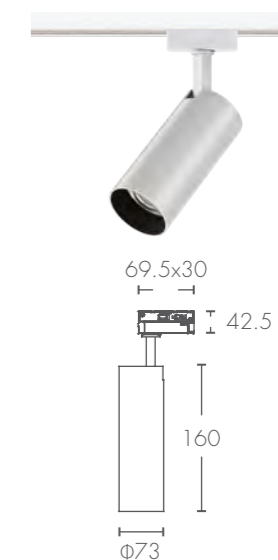
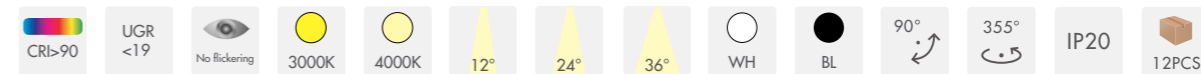
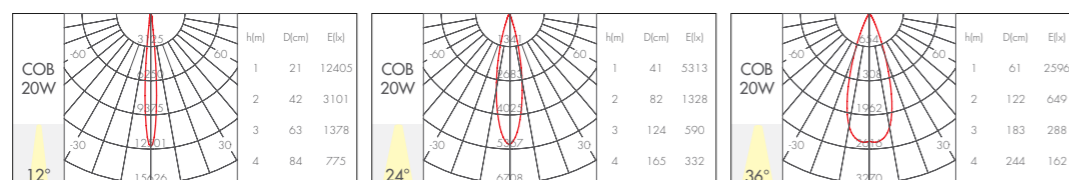

**PRODUCT DATA** 产品参数

Model 型号	Light Source 光源	Power/CCT 功率 / 色温	Light Output 光通量	Light Efficiency 光效率	Size(DxL) 尺寸	Installation 安装方式
IG-DG507320 01	COB	20W/3000K	≥1200 lm	≥60 lm/W	Φ73x160mm	2线 / 3线 / 4线
IG-DG507325 01	COB	25W/3000K	≥1500 lm	≥60 lm/W	Φ73x160mm	2线 / 3线 / 4线

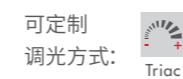

**PHOTOMETRIC** 配光参数

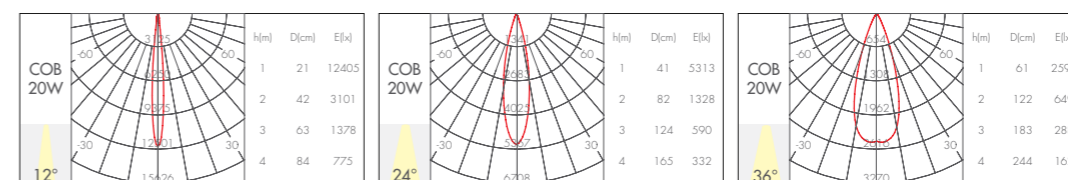



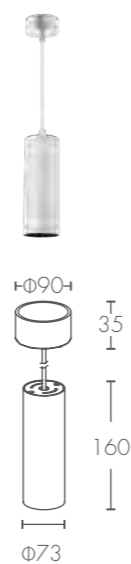

**PRODUCT DATA** 产品参数

Model 型号	Light Source 光源	Power/CCT 功率 / 色温	Light Output 光通量	Light Efficiency 光效率	Size(DxL) 尺寸	Installation 安装方式
IG-MS507320 05	COB	20W/3000K	≥1200 lm	≥60 lm/W	Φ73x160mm	吊线式
IG-MS507325 05	COB	25W/3000K	≥1500 lm	≥60 lm/W	Φ73x160mm	吊线式

可定制  
调光方式: Triac

配件  
可选项: 防眩蜂窝网片

**PHOTOMETRIC** 配光参数

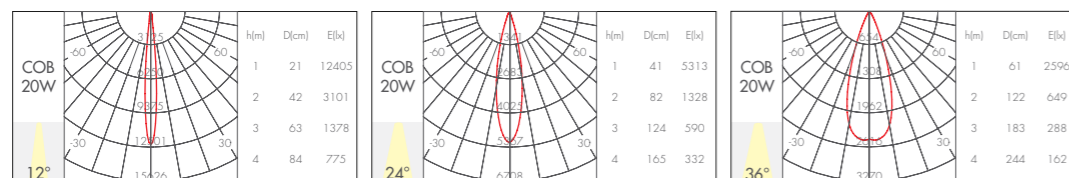

SIZE:  $\Phi$ 85mm



#### 市场应用:

店铺、星级酒店、高端别墅、会所、民宿、超市、商业综合体、展览及博物馆等

#### Applications:

Shops, star hotels, high-end villas, clubs, lodging houses, supermarkets, commercial complexes, exhibitions and museums, etc.

#### 产品特性描述:

1. 此系列产品有多种安装方式，可满足不同照明场所施工要求；
2. 产品简约，小巧精致，灯体长度最短可控制在 70mm 以内（内置驱动）；
3. 超高导热精密铝材散热，保证产品的使用寿命；
4. 产品运用深藏防眩设计，防眩角大于 45 度，只见光不见灯；
5. 灯头可垂直 90 度与水平 355 度任意调节，满足不同位置的照明需求；
6. 产品有多种光斑角度选择，如圆形光斑，矩形光斑；
7. 产品中心光强度高，光斑均匀，副光斑弱，且不明显。

#### Product Features:

1. This series of products has various installation methods to meet the construction requirements of different lighting places.
2. The product is compact, compact and exquisite. The shortest length of the lamp body can be controlled within 70mm (built-in drive).
3. High heat conduction precision aluminum heat dissipation, ensure product life.
4. The product is designed with a deep anti glare design, and the glare angle is greater than 45 degrees.
5. The lamp holder can be adjusted at 90 degrees and 355 degrees horizontally to meet the lighting needs of different locations.
6. The product has many kinds of spot angle selection, such as circular spot and rectangle spot.
7. The product center has high light intensity, uniform spot and weak spot.



导轨式

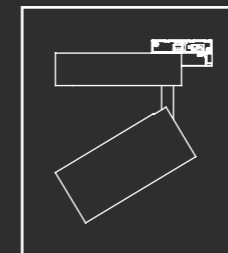

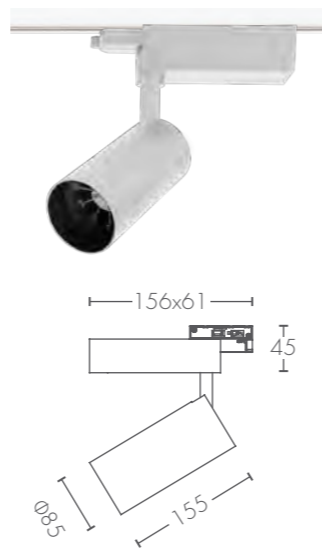

### PRODUCT DATA 产品参数

Model 型号	Light Source 光源	Power/CCT 功率 / 色温	Light Output 光通量	Light Efficiency 光效率	Size(DxL) 尺寸	Installation 安装方式
IG-DG508530 02	COB	30W/3000K	≥1950 lm	≥65 lm/W	Ø85x155mm	2线 / 3线 / 4线
IG-DG508535 02	COB	35W/3000K	≥2275 lm	≥65 lm/W	Ø85x155mm	2线 / 3线 / 4线

可定制  
调光方式:

配件  
可选项: 防眩蜂窝网片

### PHOTOMETRIC 配光参数

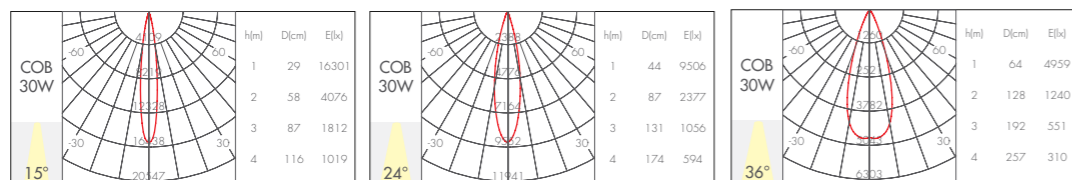



#### 市场应用:

店铺、星级酒店、高端别墅、会所、民宿、超市、商业综合体、展览及博物馆等

#### Applications:

Shops, star hotels, high-end villas, clubs, lodging houses, supermarkets, commercial complexes, exhibitions and museums, etc.

#### 产品特性描述:

1. 国际进口品牌 COB 光源, CRI > 80/90, 光效高、性能稳定, 光色一致性高;
2. 国标铝材灯体和高导热铝散热器, 确保灯具良好外观成型及充分的散热;
3. 优异配光设计并使用国内著名反射器, 光晕自然舒适, 光形好, 峰值光强度高;
4. 内置或外置恒流驱动, 外观简洁、质量稳定;
5. 产品深防眩设计, 防眩角大于 35 度;
6. 系列化产品, 款款经典, 可满足不同场合使用要求;
7. 整灯寿命长达 30000 小时。

#### Product Features:

1. The international imported brand COB light source, CRI > 80/90, has high luminous efficiency, stable performance and high consistency of light and color.
2. National standard aluminum lamp body and high thermal conductivity aluminum radiator to ensure good appearance and adequate heat dissipation for lamps and lanterns.
3. Excellent precision optical design with high quality reflector, to realise a clear light shape and high peak intensity.
4. Built in or external constant current drive, simple appearance and stable quality.
5. Deep anti glare design, anti glare angle greater than 35 degrees.
6. Serialized products, classic design, fit for different applications.
7. Lifespan up to 30,000 hours.

# 卡兹 KATZ

#### 轨道式射灯 / 吸顶式射灯

Track light/surface mounted spotlight

Page. 288

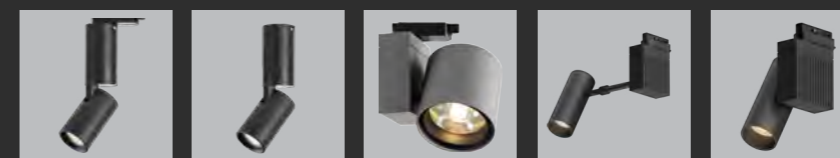

8W/12W

8W/12W

30W

25W

25W

#### 嵌入式射灯

Recessed spotlight

Page. 296



30W



CRI>90
UGR <16
No flickering
3000K
4000K
12°
15°
24°
36°
WH
BL
GR\*
90°
360°
IP20
24PCS

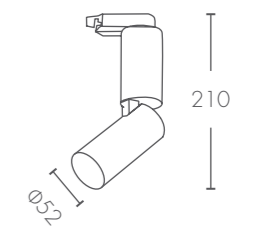

**PRODUCT DATA** 产品参数

Model 型号	Light Source 光源	Power/CCT 功率 / 色温	Light Output 光通量	Light Efficiency 光效率	Size(DxH) 尺寸	Installation 安装方式
IG-DG305208 01	COB	8W/3000K	≥480 lm	≥60 lm/W	φ52x210mm	2线 / 3线 / 4线
IG-DG305212 02	COB	12W/3000K	≥720 lm	≥60 lm/W	φ52x210mm	2线 / 3线 / 4线

配件  
 可选项：  

 聚光前嘴  
 出光效果 12°

**PHOTOMETRIC** 配光参数

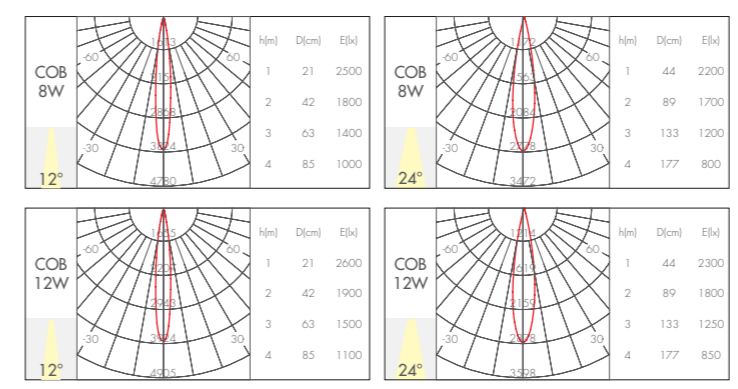

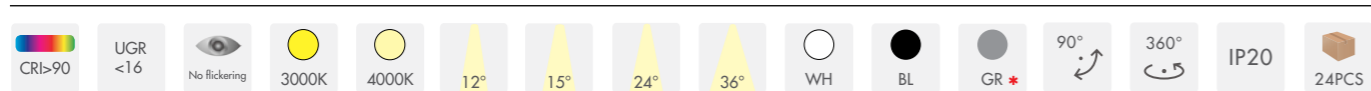

**PRODUCT DATA** 产品参数

Model 型号	Light Source 光源	Power/CCT 功率 / 色温	Light Output 光通量	Light Efficiency 光效率	Size(DxH) 尺寸	Installation 安装方式
IG-MS305208 01	COB	8W/3000K	≥480 lm	≥60 lm/W	φ52x210mm	吸顶式
IG-MS305212 02	COB	12W/3000K	≥720 lm	≥60 lm/W	φ52x210mm	吸顶式

配件  
可选项：  
聚光前嘴  
出光效果 12°

**PHOTOMETRIC** 配光参数

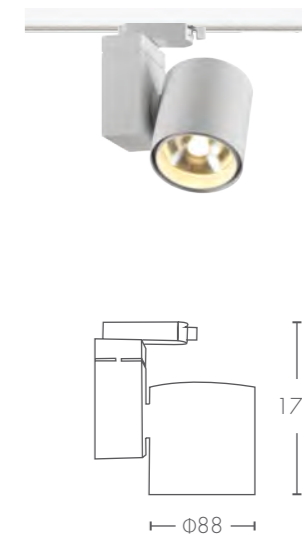
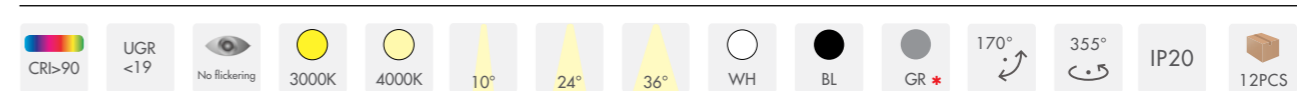
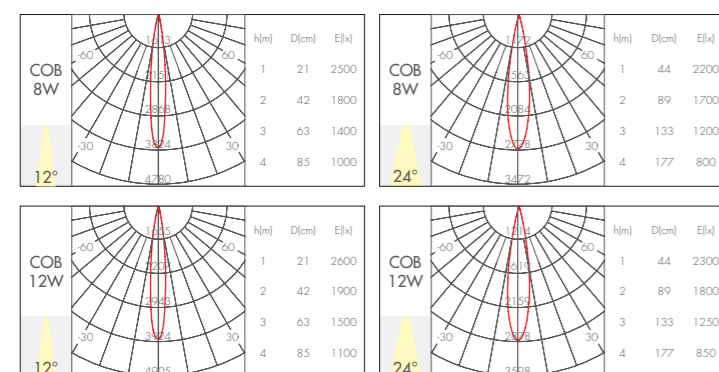

**PRODUCT DATA** 产品参数

Model 型号	Light Source 光源	Power/CCT 功率 / 色温	Light Output 光通量	Light Efficiency 光效率	Size(DxH) 尺寸	Installation 安装方式
IG-DG309530 08	COB	30W/3000K	≥2250 lm	≥75 lm/W	φ88x177mm	2线 / 3线 / 4线

可定制  
调光方式：  
Triac

**PHOTOMETRIC** 配光参数

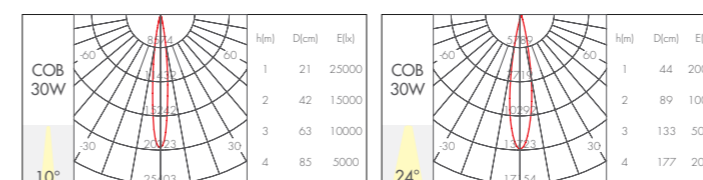



CRi>90
UGR <16
No flickering
3000K
4000K
15°
24°
36°
WH
BL
180°
360°
IP20
12PCS



**PRODUCT DATA** 产品参数

Model 型号	Light Source 光源	Power/CCT 功率 / 色温	Light Output 光通量	Light Efficiency 光效率	Size(DxH) 尺寸	Installation 安装方式
IG-DG306025 01	COB	25W/3000K	≥1625 lm	≥65 lm/W	φ60x165mm	2 线 / 3 线 / 4 线

可定制  
 调光方式: 0/1-10v Triac DALI DALI 2  
 DALI Dimming

**PHOTOMETRIC** 配光参数

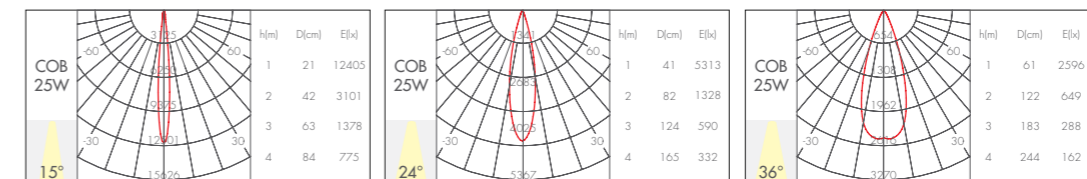



- CRI>90
- UGR <16
- No flickering
- 3000K
- 4000K
- 15°
- 24°
- 36°
- WH
- BL
- 180°
- 360°
- IP20
- 12PCS

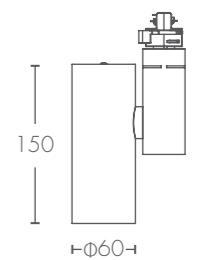

**PRODUCT DATA** 产品参数

Model 型号	Light Source 光源	Power/CCT 功率 / 色温	Light Output 光通量	Light Efficiency 光效率	Size(DxH) 尺寸	Installation 安装方式
IG-DG306025 02	COB	25W/3000K	≥1625 lm	≥65 lm/W	φ60x165mm	2线 / 3线 / 4线

- 可定制  
调光方式:
- 0/1-10v
  - Triac
  - DALI
  - DALI 2
- DALI Dimming

**PHOTOMETRIC** 配光参数

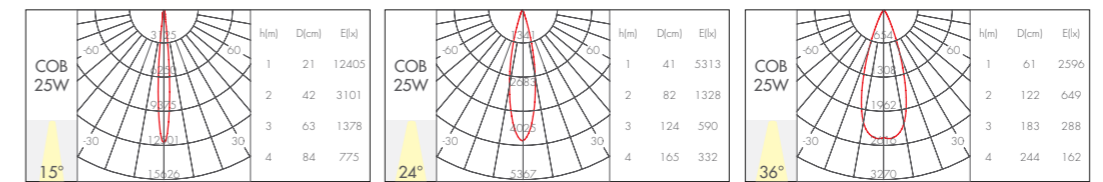



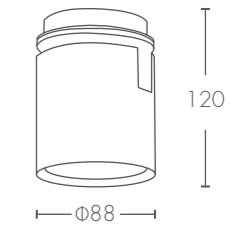
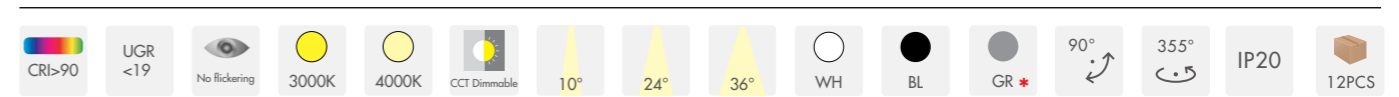

### PRODUCT DATA 产品参数

Model 型号	Light Source 光源	Power/CCT 功率 / 色温	Light Output 光通量	Light Efficiency 光效率	Size(DxH) 尺寸	Cutout 开孔尺寸
IG-TH308530	COB	30W/3000K	≥2250 lm	≥75 lm/W	Ø88x120mm	Ø85mm

可定制  
调光方式:



### PHOTOMETRIC 配光参数

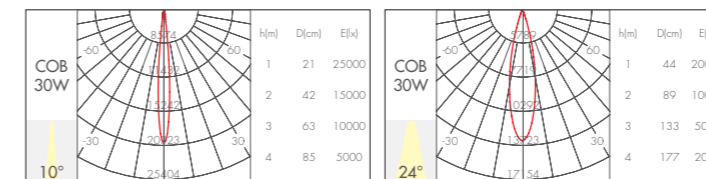



#### 市场应用:

店铺、星级酒店、高端别墅、会所、民宿、超市、商业综合体、展览及博物馆等

#### Applications:

Shops, star hotels, high-end villas, clubs, lodging houses, supermarkets, commercial complexes, exhibitions and museums, etc.

#### 产品特性描述:

1. 国际进口品牌光源, CRI > 80/90, 光效高、性能稳定, 光色一致性高;
2. 国标铝材灯体和冷锻散热器, 确保灯具良好外观成型及充分的散热;
3. 优异配光设计并使用国内著名反射器, 光晕自然舒适, 光形好, 峰值光强度高;
4. 内置隔离恒流驱动, 外观简洁、质量稳定;
5. 产品深防眩设计, 防眩角大于 35 度;
6. 系列化产品, 款款经典, 可满足不同场合使用要求;
7. 整灯寿命长达 30000 小时。

#### Product Features:

1. The international import brand light source, CRI > 80/90, has high luminous efficiency, stable performance and high consistency of light and color.
2. High quality aluminum heat sink to ensure ingenious shape and increase heat dissipation space.
3. Excellent precision optical design with high quality reflector, to realise a clear light shape and high peak intensity.
4. High quality isolated constant current driver. Dimming, intelligent control functions for option.
5. Deep anti glare design, anti glare angle greater than 35 degrees.
6. Serialized products, classic design, fit for different applications.
7. Lifespan up to 30,000 hours.

# 照相机 CAMERA

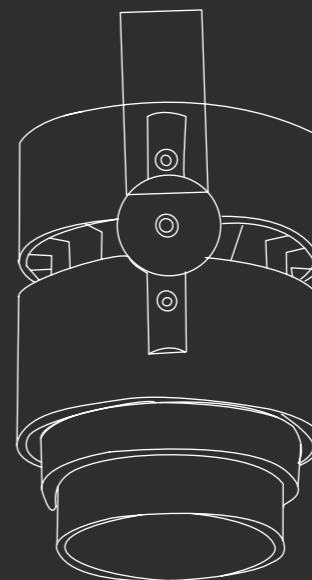

#### 轨道式射灯

Track light



12W/20W

30W



- CRI>90
- UGR <19
- No flickering
- 3000K
- 4000K
- 15°
- 24°
- 36°
- WH
- BL
- GR
- 90°
- 360°
- IP20
- 12PCS

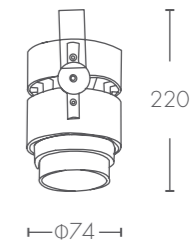

**PRODUCT DATA** 产品参数

Model 型号	Light Source 光源	Power/CCT 功率 / 色温	Light Output 光通量	Light Efficiency 光效率	Size(DxH) 尺寸	Installation 安装方式
IG-DG308512 01	COB	12W/3000K	≥720 lm	≥74 lm/W	Φ74x220mm	2线 / 3线 / 4线
IG-DG308520 02	COB	20W/3000K	≥1200 lm	≥74 lm/W	Φ74x220mm	2线 / 3线 / 4线

**PHOTOMETRIC** 配光参数

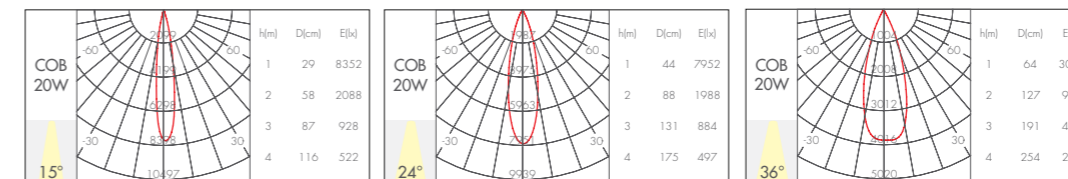

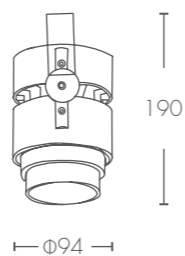

**PRODUCT DATA** 产品参数

Model 型号	Light Source 光源	Power/CCT 功率 / 色温	Light Output 光通量	Light Efficiency 光效率	Size(DxH) 尺寸	Installation 安装方式
IG-DG310330 03	COB	30W/3000K	≥1950 lm	≥65 lm/W	Φ94x190mm	2 线 / 3 线 / 4 线

**PHOTOMETRIC** 配光参数

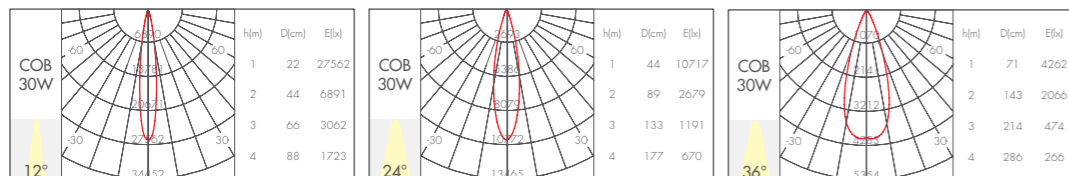



#### 市场应用:

店铺、星级酒店、高端别墅、会所、民宿、超市、商业综合体、展览及博物馆等

#### Applications:

Shops, star hotels, high-end villas, clubs, lodging houses, supermarkets, commercial complexes, exhibitions and museums, etc.

#### 产品特性描述:

1. 国际进口品牌光源, CRI > 80/90, 光效高、性能稳定, 光色一致性高;
2. 进口高纯度高导热精密压铸而成的散热器, 确保灯具良好外观成型及充分的散热;
3. 优异配光设计并使用国内著名反射器, 光晕自然舒适, 光形好, 峰值光强度高;
4. 内置隔离恒流驱动, 外观简洁、质量稳定;
5. 产品深防眩设计, 防眩角大于 35 度;
6. 系列化产品, 款款经典, 可满足不同场合使用要求;
7. 整灯寿命长达 30000 小时。

#### Product Features:

1. The international import brand light source, CRI > 80/90, has high luminous efficiency, stable performance and high consistency of light and color.
2. Imported high precision and high heat conduction precision die-casting radiator to ensure good appearance and adequate heat dissipation of lamps and lanterns.
3. Excellent precision optical design with high quality reflector, to realise a clear light shape and high peak intensity.
4. High quality isolated constant current driver. Dimming, intelligent control functions for option.
5. Deep anti glare design, anti glare angle greater than 35 degrees.
6. Serialized products, classic design, fit for different applications.
7. Lifespan up to 30,000 hours.

# 木马人 TROJAN PEOPLE II

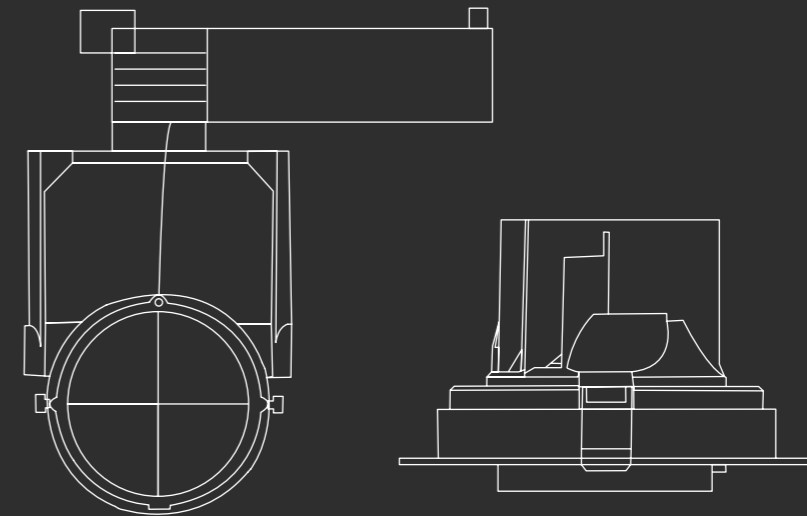

#### 轨道式射灯

Track light

Page. 306



30W/35W

#### 嵌入式射灯

Recessed spotlight

Page. 308



30W/35W



- CRI>90
- UGR <19
- No flickering
- 3000K
- 4000K
- 12°
- 24°
- 36°
- WH
- BL
- GR
- 180°
- 355°
- IP20
- 12PCS

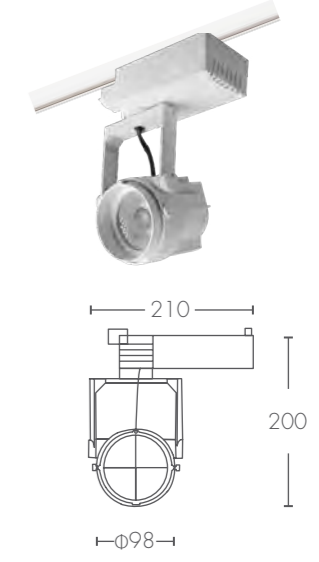

**PRODUCT DATA** 产品参数

Model 型号	Light Source 光源	Power/CCT 功率 / 色温	Light Output 光通量	Light Efficiency 光效率	Size(DxLxH) 尺寸	Installation 安装方式
IG-DG109830 01	COB	30W/3000K	≥1950 lm	≥65 lm/W	φ98x210x200mm	2线 / 3线 / 4线
IG-DG109835 02	COB	35W/3000K	≥2275 lm	≥65 lm/W	φ98x210x200mm	2线 / 3线 / 4线

可定制  
调光方式: Triac

**PHOTOMETRIC** 配光参数

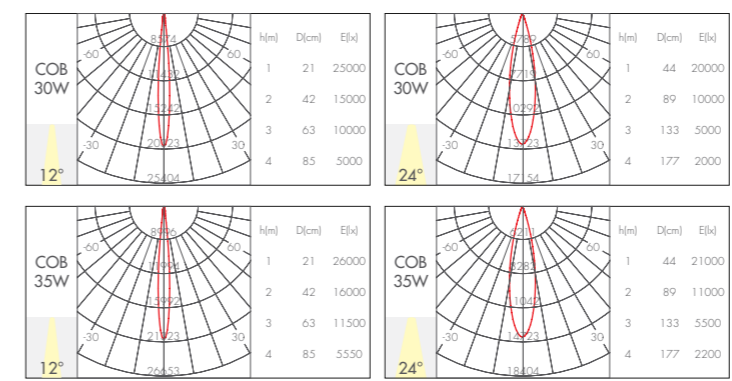

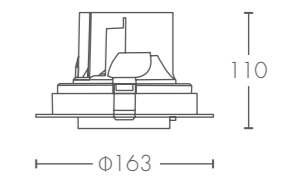
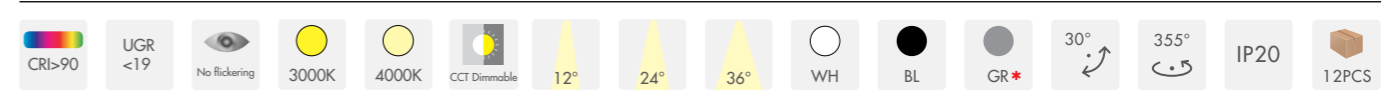

**PRODUCT DATA** 产品参数

Model 型号	Light Source 光源	Power/CCT 功率 / 色温	Light Output 光通量	Light Efficiency 光效率	Size(DxH) 尺寸	Cutout 开孔尺寸
IG-TH114530	COB	30W/3000K	≥2100 lm	≥60 lm/W	Φ163x110mm	Φ145mm
IG-TH114535	COB	35W/3000K	≥2450 lm	≥60 lm/W	Φ163x110mm	Φ145mm

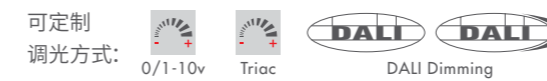

**PHOTOMETRIC** 配光参数

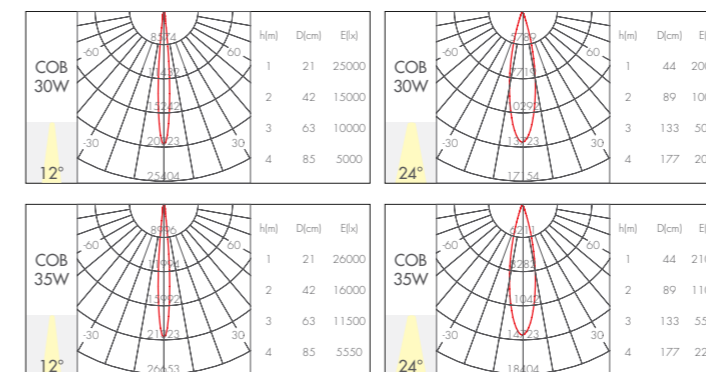



#### 市场应用:

店铺、星级酒店、高端别墅、会所、民宿、超市、商业综合体、展览及博物馆等

#### Applications:

Shops, star hotels, high-end villas, clubs, lodging houses, supermarkets, commercial complexes, exhibitions and museums, etc.

#### 产品特性描述:

1. 国际进口品牌光源, CRI > 80/90, 光效高、性能稳定, 光色一致性高;
2. 进口高纯度高热精密压铸而成的散热器, 确保灯具良好外观成型及充分的散热;
3. 优异配光设计并使用国内著名反射器, 光晕自然舒适, 光形好, 峰值光强度高;
4. 内置隔离恒流驱动, 外观简洁、质量稳定;
5. 修长的灯臂使暗槽于天花灯槽内的导轨灯轻易延伸出来, 照射覆盖范围优于一般导轨灯;
6. 拥有双杆杠结构灯臂, 使灯具拥有灵活自如的转向功能;
7. 侧装式更加适合对导轨灯具隐蔽性要求更高的照明环境, 灯具可以完全隐藏于天花板中。

#### Product Features:

1. The international import brand light source, CRI > 80/90, has high luminous efficiency, stable performance and high consistency of light and color.
2. Imported high precision and high heat conduction precision die-casting radiator to ensure good appearance and adequate heat dissipation of lamps and lanterns.
3. Excellent precision optical design with high quality reflector, to realise a clear light shape and high peak intensity.
4. High quality isolated constant current driver. Dimming, intelligent control functions for option.
5. The slender lamp arm makes the guide lamp with dark groove in the ceiling lamp groove easily extend out, and the irradiation coverage is better than the general guide lamp.
6. The lamp arm with parallel bar structure enables the lamp to have flexible and free turning function.
7. Side mounted lighting is more suitable for lighting environment which requires higher concealment of guideway lamps, which can be completely hidden in the ceiling.

# 自由人 FREEMAN

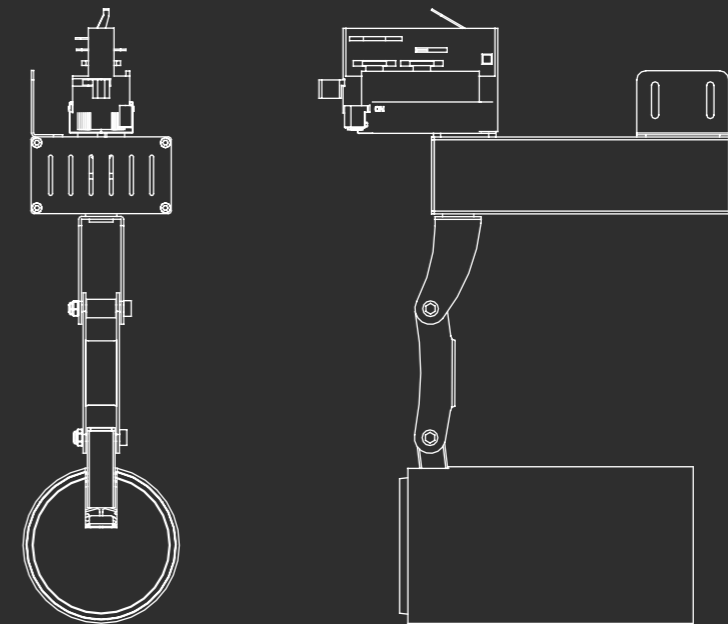

#### 轨道式射灯

Track light

Page. 312

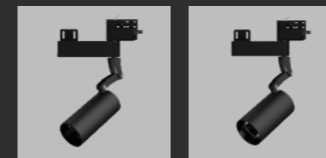

20W/25W

30W/35W





- CRI>90
- UGR <19
- No flickering
- 3000K
- 4000K
- 12°
- 24°
- 36°
- WH
- BL
- 90°
- 355°
- IP20
- 12PCS



**PRODUCT DATA** 产品参数

Model 型号	Light Source 光源	Power/CCT 功率 / 色温	Light Output 光通量	Light Efficiency 光效率	Size(DxLxH) 尺寸	Installation 安装方式
IG-DG507320 06	COB	20W/3000K	≥1200 lm	≥60 lm/W	φ73x160x307mm	2线 / 3线 / 4线
IG-DG507325 06	COB	25W/3000K	≥1500 lm	≥60 lm/W	φ73x160x307mm	2线 / 3线 / 4线

可定制  
调光方式: 0/1-10v Triac

配件  
可选项: 防眩蜂窝网片

**PHOTOMETRIC** 配光参数

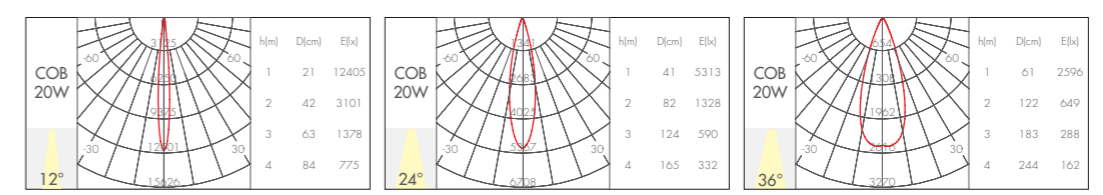

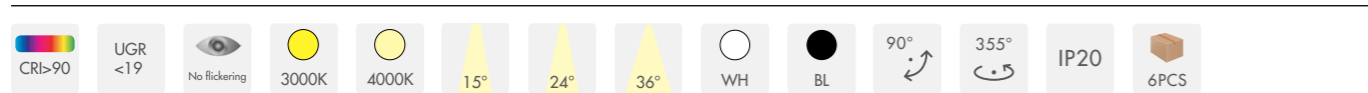

**PRODUCT DATA** 产品参数

Model 型号	Light Source 光源	Power/CCT 功率 / 色温	Light Output 光通量	Light Efficiency 光效率	Size(DxLxH) 尺寸	Installation 安装方式
IG-DG508530 06	COB	30W/3000K	≥1950 lm	≥65 lm/W	Φ85x155x323mm	2线 / 3线 / 4线
IG-DG508535 06	COB	35W/3000K	≥2275 lm	≥65 lm/W	Φ85x155x323mm	2线 / 3线 / 4线

可定制  
调光方式:

配件  
可选项: 防眩蜂窝网片

**PHOTOMETRIC** 配光参数

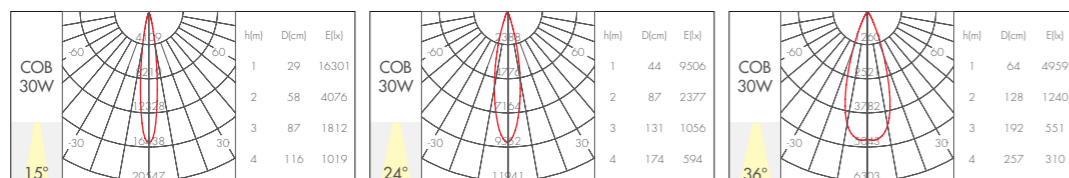

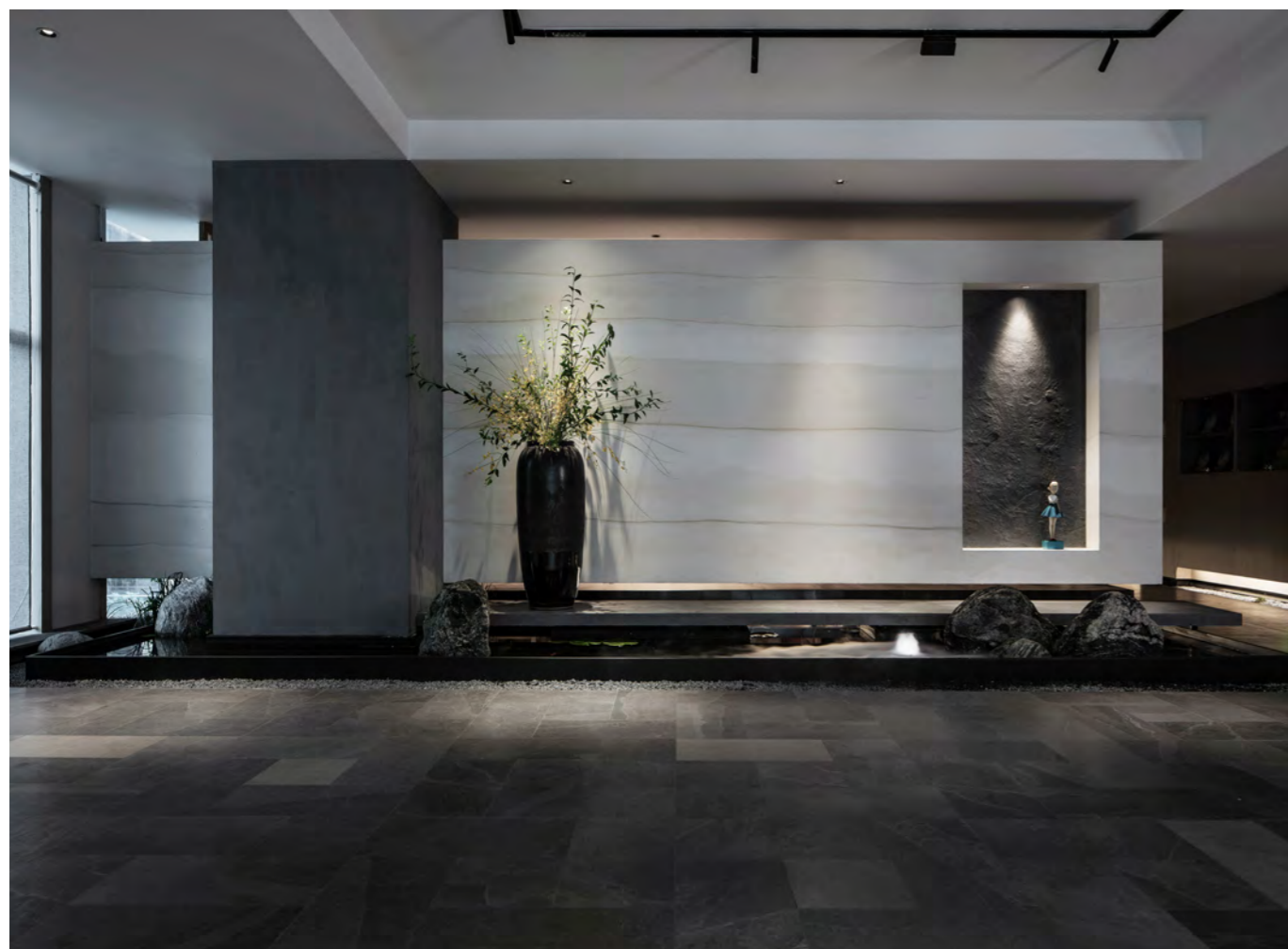

# 磁吸线型灯

磁吸线型灯  
Magnetically absorbent lamp

Page. 318



3W      8W      12W      20W      10W/20W/30W      12W      30W      20W



CRIs>90
UGR <19
No flickering
2700K
3000K
4000K
15°
24°
36°
WH
BL
90°
355°
IP20
L160mm\*

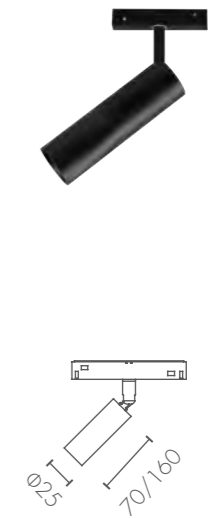

**PRODUCT DATA** 产品参数

Model 型号	Light Source 光源	Power/CCT 功率 / 色温	Light Output 光通量	Light Efficiency 光效率	Candela/Angle 中心光强 / 角度	Size(DxL) 尺寸	Installation 安装方式
IG-CX502503	SMD	3W/3000K	≥100 lm	≥33 lm/W	2000 cd/10°	Ø25x70mm Ø25x160mm*	磁吸式

可定制  
 调光方式:  0/1-10v  DALI Dimming

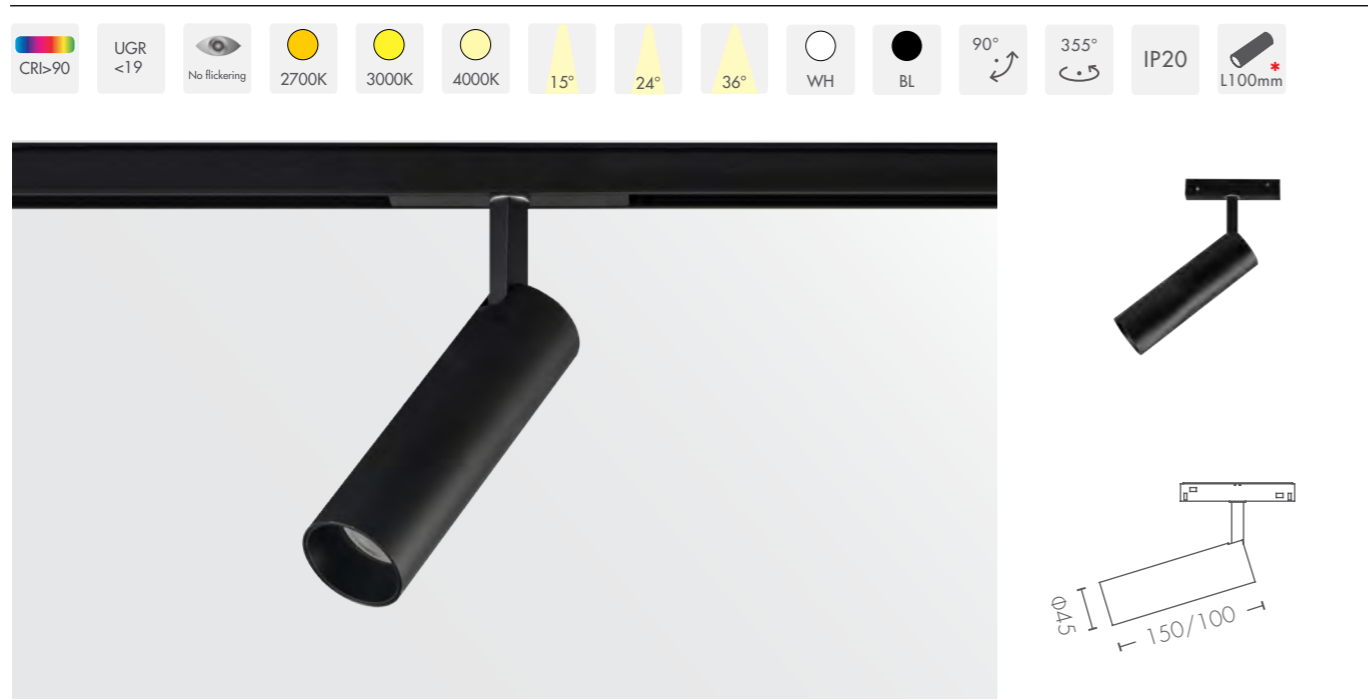

**PRODUCT DATA** 产品参数

Model 型号	Light Source 光源	Power/CCT 功率 / 色温	Light Output 光通量	Light Efficiency 光效率	Size(DxL) 尺寸	Installation 安装方式
IG-CX504508	COB	8W/3000K	≥560 lm	≥70 lm/W	Φ45x150mm Φ45x100mm*	磁吸式

可定制  
调光方式:  0/1-10v  DALI Dimming

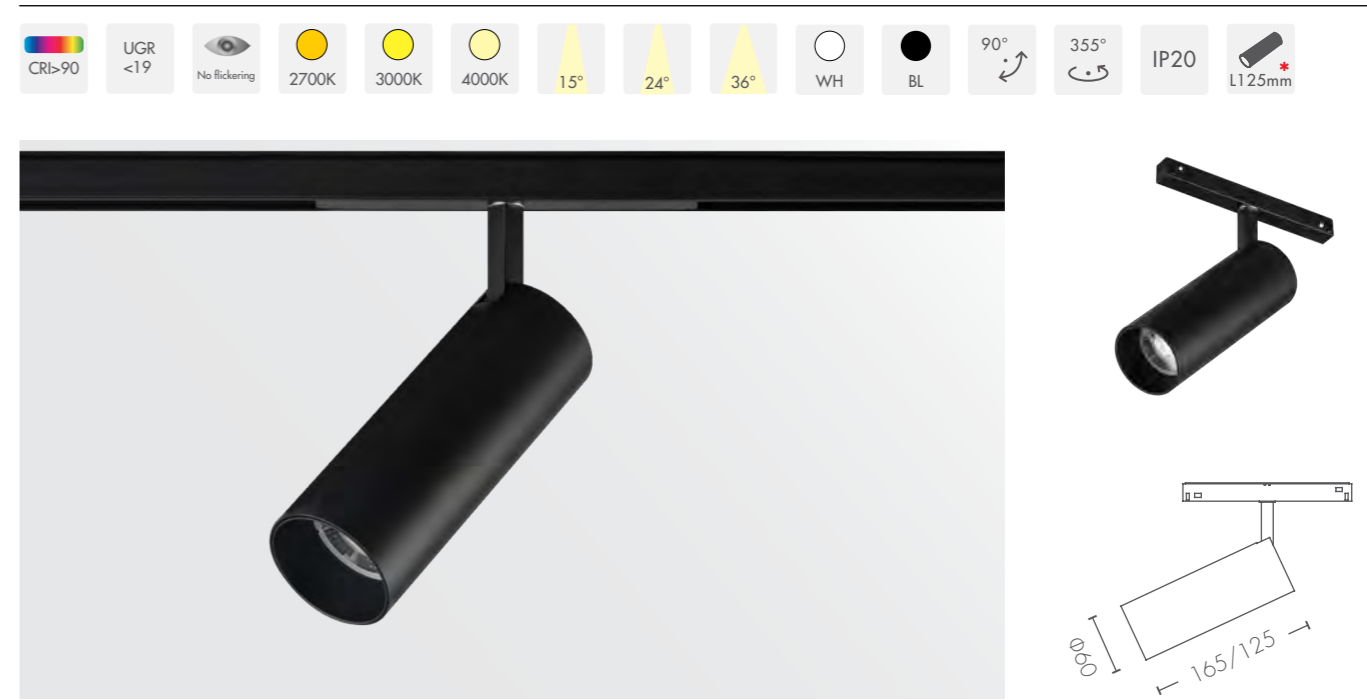

**PRODUCT DATA** 产品参数

Model 型号	Light Source 光源	Power/CCT 功率 / 色温	Light Output 光通量	Light Efficiency 光效率	Size(DxL) 尺寸	Installation 安装方式
IG-CX506012	COB	12W/3000K	≥840 lm	≥70 lm/W	Φ60x165mm Φ60x125mm*	磁吸式

可定制  
调光方式:  0/1-10v  DALI Dimming

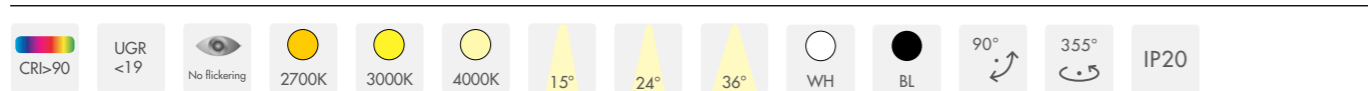

**PRODUCT DATA** 产品参数

Model 型号	Light Source 光源	Power/CCT 功率 / 色温	Light Output 光通量	Light Efficiency 光效率	Size(DxL) 尺寸	Installation 安装方式
IG-CX507312	COB	20W/3000K	≥1400 lm	≥70 lm/W	φ73x160mm	磁吸式

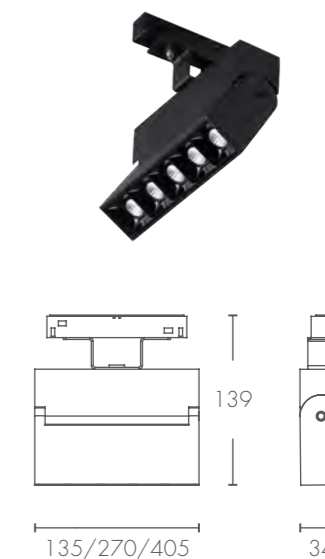
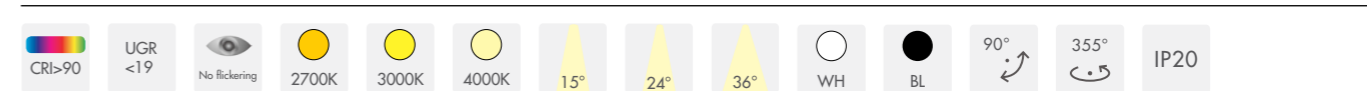

**PRODUCT DATA** 产品参数

Model 型号	Light Source 光源	Power/CCT 功率 / 色温	Light Output 光通量	Light Efficiency 光效率	Size(LxWxH) 尺寸	Installation 安装方式
IG-M35-LB-5	COB	10W/3000K	≥600 lm	≥60 lm/W	135x34x139mm	磁吸式
IG-M35-LB-10	COB	20W/3000K	≥1200 lm	≥60 lm/W	270x34x139mm	磁吸式
IG-M35-LB-15	COB	30W/3000K	≥1800 lm	≥60 lm/W	405x34x139mm	磁吸式



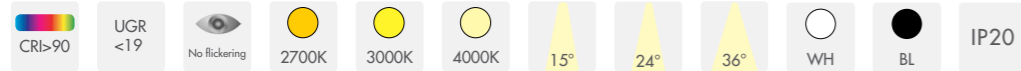

**PRODUCT DATA** 产品参数

Model 型号	Light Source 光源	Power/CCT 功率 / 色温	Light Output 光通量	Light Efficiency 光效率	Size(LxWxH) 尺寸	Installation 安装方式
IG-CX011212-6	COB	12W/3000K	≥720 lm	≥60 lm/W	112x22x43mm	磁吸式

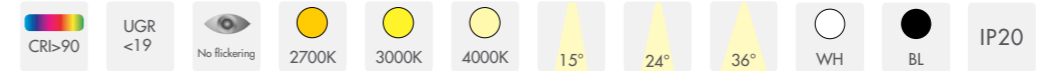

**PRODUCT DATA** 产品参数

Model 型号	Light Source 光源	Power/CCT 功率 / 色温	Light Output 光通量	Light Efficiency 光效率	Size(LxWxH) 尺寸	Installation 安装方式
IG-CX027012-10	COB	30W/3000K	≥1800 lm	≥60 lm/W	270x34x69mm	磁吸式



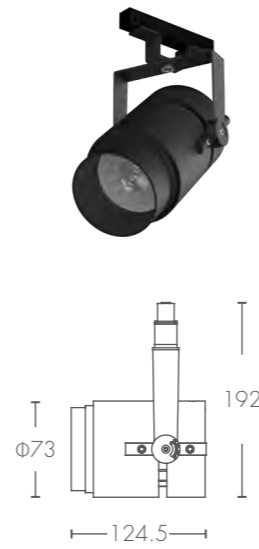
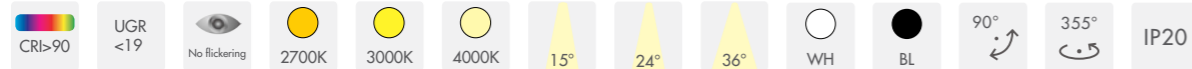

**PRODUCT DATA** 产品参数

Model 型号	Light Source 光源	Power/CCT 功率/色温	Light Output 光通量	Light Efficiency 光效率	Size(DxL) 尺寸	Installation 安装方式
IG-CX308520	COB	20W/3000K	≥1200 lm	≥60 lm/W	φ73x192mm	磁吸式



**磁吸轨道**  
Magnetic track

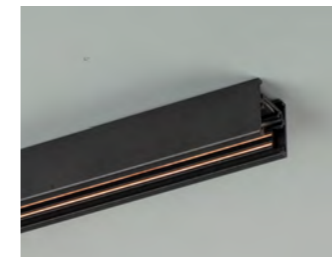

**Model** 型号: S2035-1 明装轨  
**Color** 颜色: 氧化砂黑  
**Installation** 安装方式: 明装 / 吊装  
**Material** 外壳材料: 铝材 Auminum  
**Length** 包装规格: 1M/2M/3M  
**Size(WxH)** 尺寸: 27x27mm

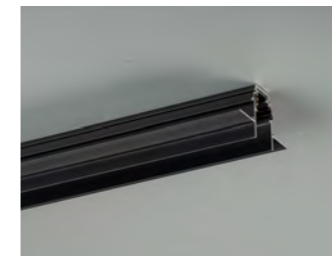
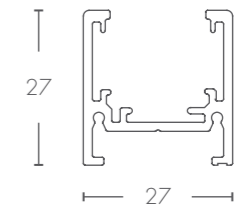

**Model** 型号: R20 嵌装轨  
**Color** 颜色: 氧化砂黑  
**Installation** 安装方式: 开槽 40mm  
**Material** 外壳材料: 铝材 Auminum  
**Length** 包装规格: 1M/2M/3M  
**Size(WxH)** 尺寸: 72x47mm

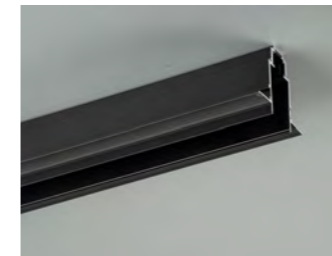
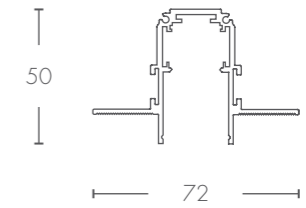

**Model** 型号: R35-2 嵌装轨  
**Color** 颜色: 氧化砂黑  
**Installation** 安装方式: 开槽 50mm  
**Material** 外壳材料: 铝材 Auminum  
**Length** 包装规格: 1M/2M/3M  
**Size(WxH)** 尺寸: 84x72mm

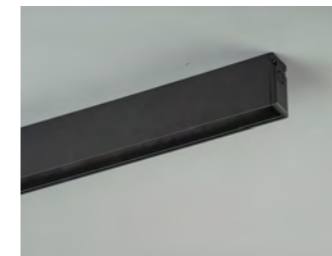
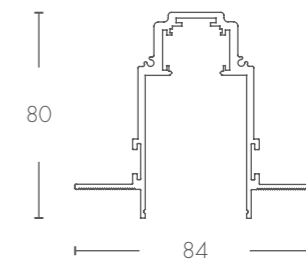

**Model** 型号: S20 明装 / 吊装轨  
**Color** 颜色: 喷粉砂黑  
**Installation** 安装方式: 明装 / 吊装  
**Material** 外壳材料: 铝材 Auminum  
**Length** 包装规格: 1M/2M/3M  
**Size(WxH)** 尺寸: 26.5x53mm

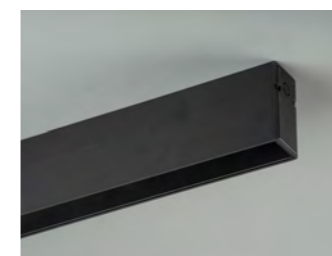
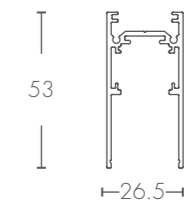

**Model** 型号: S35 明装 / 吊装轨  
**Color** 颜色: 喷粉砂黑  
**Installation** 安装方式: 明装 / 吊装  
**Material** 外壳材料: 铝材 Auminum  
**Length** 包装规格: 1M/2M/3M  
**Size(WxH)** 尺寸: 35x79mm

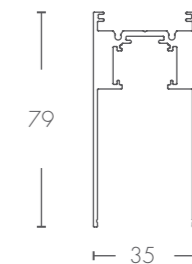





# 办公教育灯

办公灯  
Office light



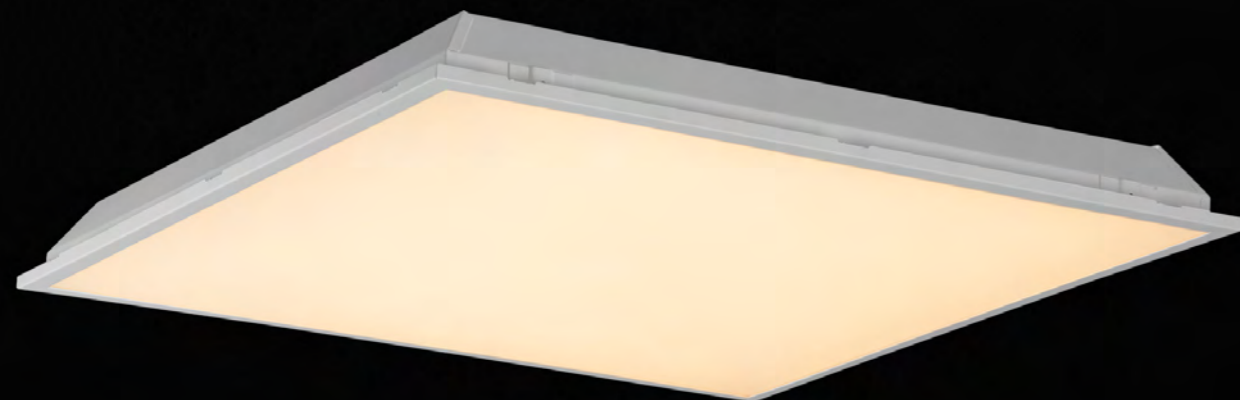

- CRI>80
- UGR <19
- No flickering
- 3000K
- 4000K
- 120°
- WH
- IP20



**PRODUCT DATA** 产品参数

Model 型号	Light Source 光源	Power/CCT 功率 / 色温	Light Output 光通量	Light Efficiency 光效率	Size(DxLxH) 尺寸	Cutout 开孔尺寸
IG-DP303018 01	SMD	18W/3000K	≥1450 lm	≥80 lm/W	298x298x60mm	285x285mm
IG-DP603018 01	SMD	18W/3000K	≥1450 lm	≥80 lm/W	598x298x60mm	585x285mm
IG-DP606036 01	SMD	36W/3000K	≥2800 lm	≥78 lm/W	598x598x60mm	585x585mm
IG-DP301236 01	SMD	36W/3000K	≥2800 lm	≥78 lm/W	1198x298x60mm	1185x285mm
IG-DP601272 01	SMD	72W/3000K	≥5500 lm	≥76 lm/W	1198x598x60mm	1185x585mm

**INSTALLATION** 安装方式

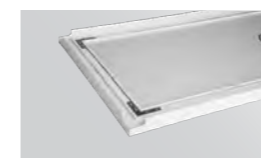

Integrated Ceiling  
集成吊顶

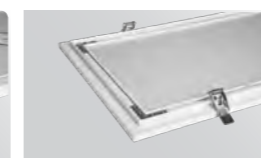

Shrapnel  
暗装

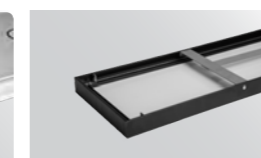

Ceiling Mounting  
明装



Aluminium Grid  
铝格栅



Hoisting  
吊线安装

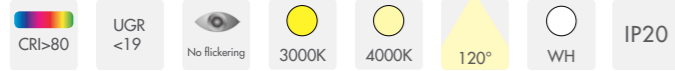

**PRODUCT DATA** 产品参数

Model 型号	Light Source 光源	Power/CCT 功率 / 色温	Light Output 光通量	Light Efficiency 光效率	Size(DxLxH) 尺寸	Cutout 开孔尺寸
IG-DP303018 02	SMD	18W/3000K	≥1350 lm	≥80 lm/W	300x300x10mm	285x285mm
IG-DP603018 02	SMD	18W/3000K	≥1350 lm	≥80 lm/W	600x300x10mm	585x285mm
IG-DP606036 02	SMD	36W/3000K	≥2700 lm	≥78 lm/W	600x600x10mm	585x585mm
IG-DP301236 02	SMD	36W/3000K	≥2700 lm	≥78 lm/W	1200x300x10mm	1185x285mm
IG-DP601290 02	SMD	90W/3000K	≥6300 lm	≥76 lm/W	1200x600x10mm	1185x585mm

**INSTALLATION** 安装方式

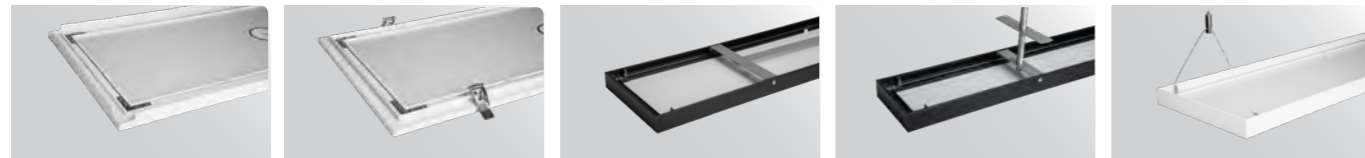

Integrated Ceiling 集成吊顶    Shrapnel 暗装    Ceiling Mounting 明装    Aluminium Grid 铝格栅    Hoisting 吊线安装

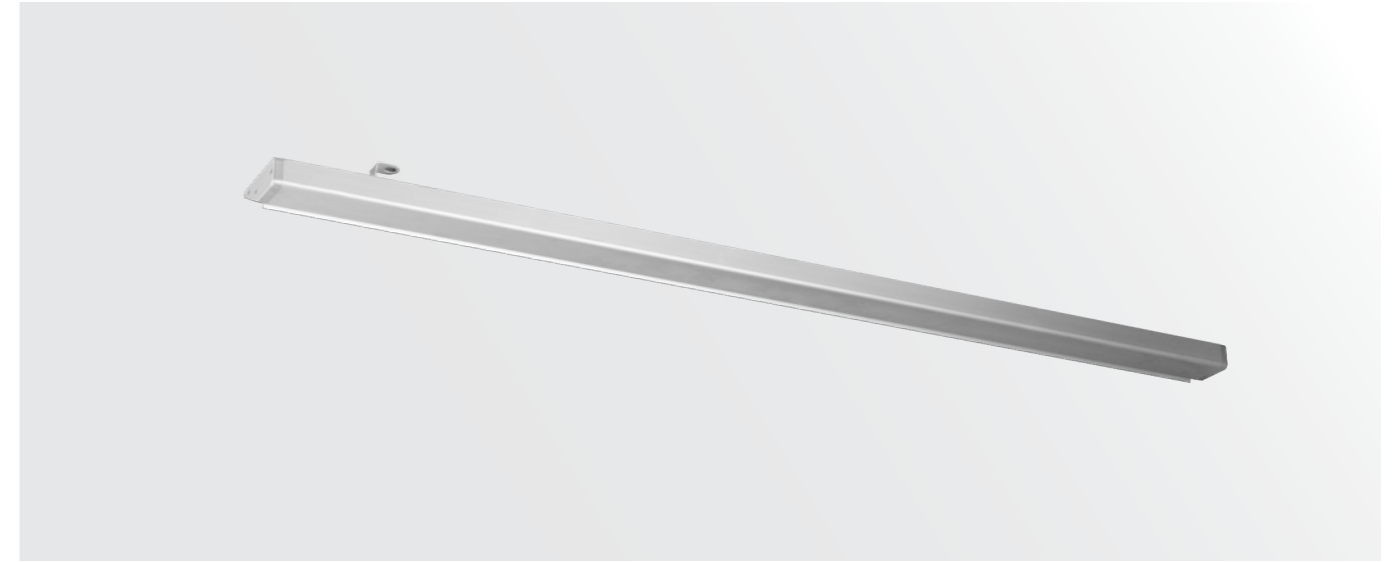
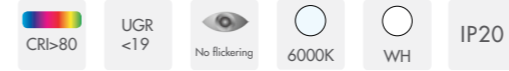

**PRODUCT DATA** 产品参数

Model 型号	Light Source 光源	Power/CCT 功率 / 色温	Light Output 光通量	Light Efficiency 光效率	Size(LxWxH) 尺寸	Installation 安装方式
IG-BG010040 01	SMD	40W/3000K	≥3203 lm	≥78 lm/W	1200x100x33mm	明装式

**PHOTOMETRIC** 配光参数

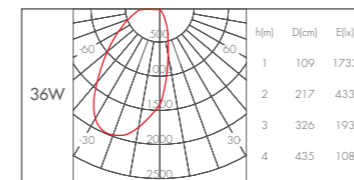

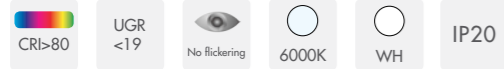

**PRODUCT DATA** 产品参数

Model 型号	Light Source 光源	Power/CCT 功率 / 色温	Light Output 光通量	Light Efficiency 光效率	Size(LxWxH) 尺寸	Installation 安装方式
IG-BG029272 01	LED T8	2x18W/4000K	≥2x2101 lm	≥2x59 lm/W	1230x292x100mm	明装式

**PHOTOMETRIC** 配光参数

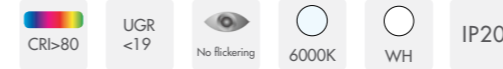
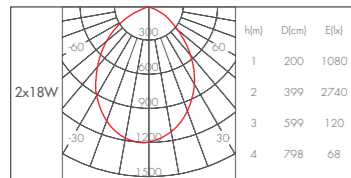

**PRODUCT DATA** 产品参数

Model 型号	Light Source 光源	Power/CCT 功率 / 色温	Light Output 光通量	Light Efficiency 光效率	Size(LxWxH) 尺寸	Installation 安装方式
IG-BG017536 01	LED T8	1x18W/3000K 2x18W/3000K	≥2x1348 lm	≥2x76 lm/W	1223x170x145mm	明装式

**PHOTOMETRIC** 配光参数

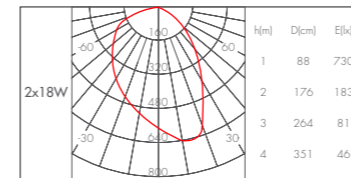

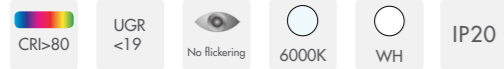

**PRODUCT DATA** 产品参数

Model 型号	Light Source 光源	Power/CCT 功率 / 色温	Light Output 光通量	Light Efficiency 光效率	Size(LxWxH) 尺寸	Installation 安装方式
IG-BG021336 01	LED T8	18W/3000K	≥1373 lm	≥78 lm/W	1224x213x95mm	明装式

**PHOTOMETRIC** 配光参数

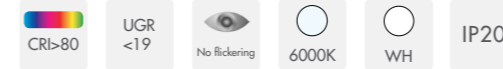
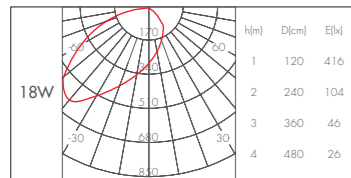

**PRODUCT DATA** 产品参数

Model 型号	Light Source 光源	Power/CCT 功率 / 色温	Light Output 光通量	Light Efficiency 光效率	Size(LxWxH) 尺寸	Installation 安装方式
IG-BG029336 01	SMD	36W/3000K	≥2891 lm	≥78 lm/W	1203x293x76mm	明装式

**PHOTOMETRIC** 配光参数

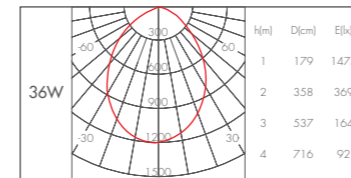

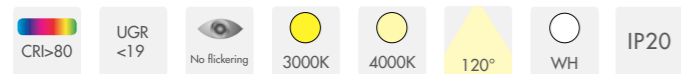

#### PRODUCT DATA 产品参数

Model 型号	Light Source 光源	Power/CCT 功率 / 色温	Light Output 光通量	Light Efficiency 光效率	Size(DxLxH) 尺寸	Cutout 开孔尺寸
IG-DP603040 01	LED T8	2x10W/3000K	≥4000 lm	≥100 lm/W	598x298x76mm	585x285mm
IG-DP606080 01	LED T8	4x10W/3000K	≥8000 lm	≥100 lm/W	598x598x76mm	585x585mm
IG-DP301272 01	LED T8	2x18W/3000K	≥7200 lm	≥100 lm/W	1198x298x76mm	1185x285mm
IG-DP6012144 01	LED T8	4x18W/3000K	≥14400 lm	≥100 lm/W	1198x598x76mm	1185x585mm
IG-DP603020 02	SMD	2x10W/3000K	≥2000 lm	≥100 lm/W	598x298x76mm	585x285mm
IG-DP606040 02	SMD	4x10W/3000K	≥4000 lm	≥100 lm/W	598x598x76mm	585x585mm
IG-DP301236 02	SMD	2x18W/3000K	≥3600 lm	≥100 lm/W	1198x298x76mm	1185x285mm
IG-DP601272 02	SMD	4x18W/3000K	≥7200 lm	≥100 lm/W	1198x598x76mm	1185x585mm



#### PRODUCT DATA 产品参数

Model 型号	Light Source 光源	Power/CCT 功率 / 色温	Light Output 光通量	Light Efficiency 光效率	Size(DxLxH) 尺寸	Installation 安装方式
IG-XD028012 02	SMD	12W/3000K	≥780 lm	≥65 lm/W	Φ260x65mm	雷达感应吸顶式
IG-XD028012 03	SMD	12W/3000K	≥780 lm	≥65 lm/W	Φ260x65mm	人体感应吸顶式

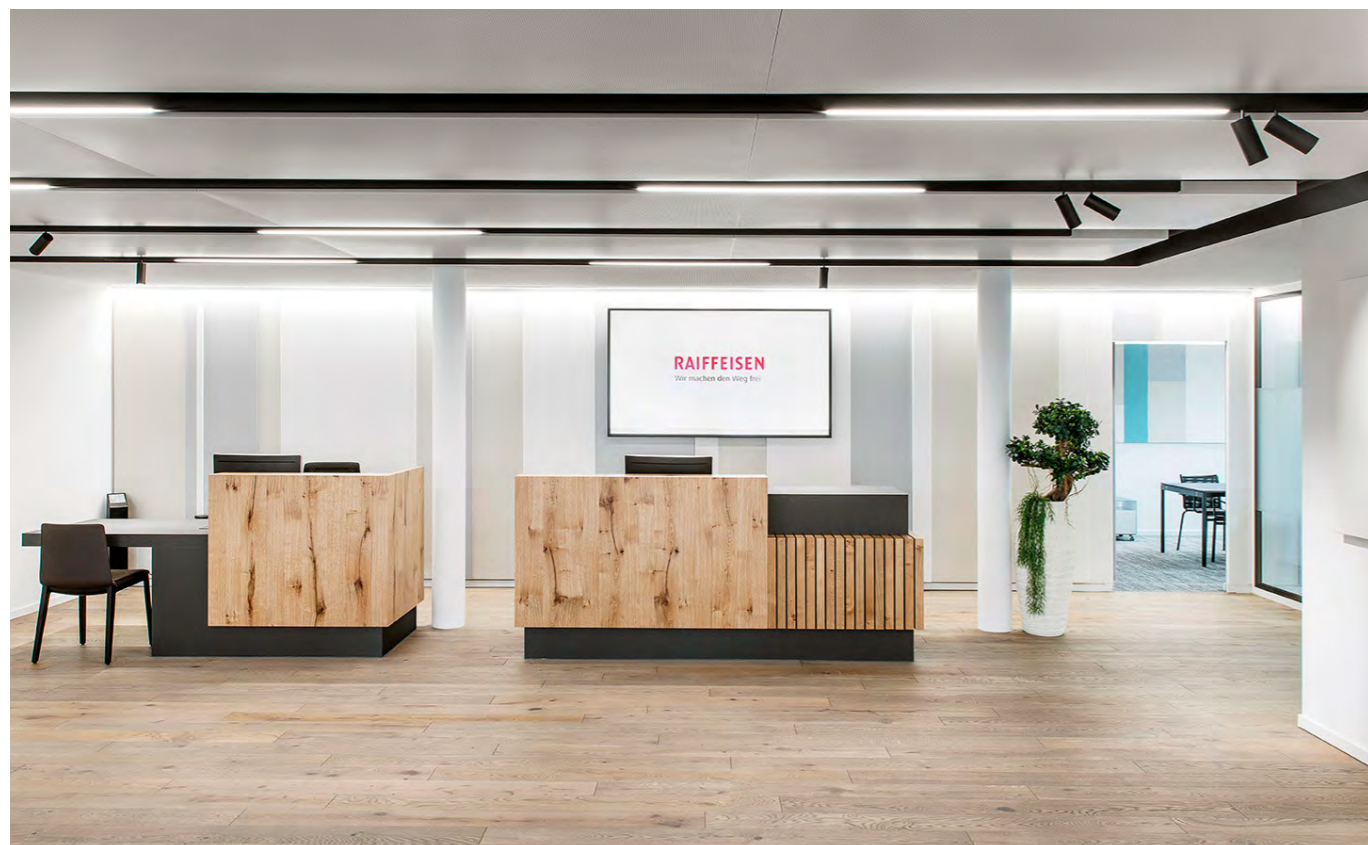
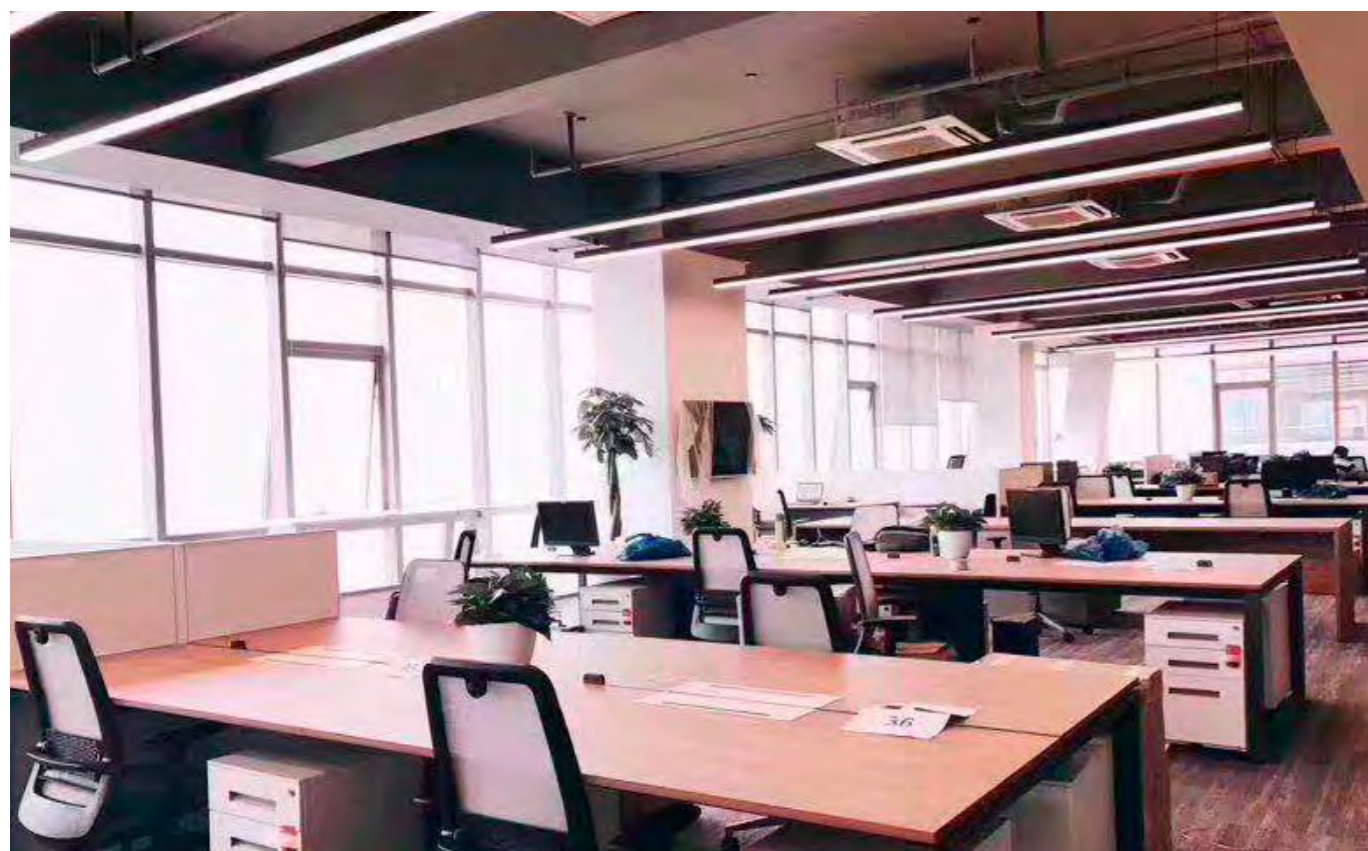

# 办公线型灯

线型灯  
Linear lamp

Page. 342

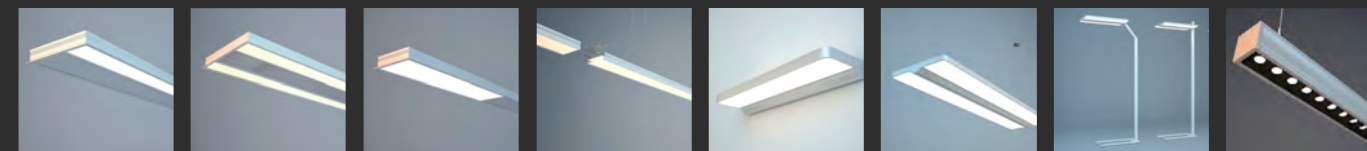

15W/30W    2x15W/2x30W    15W    24W/m    2x12W  
2x15W/2x30W    4x15W/4x30W    4x15W    90W+30W



135W+45W    45W+15W    15W/20W/30W/45W    30W/40W/60W/90W

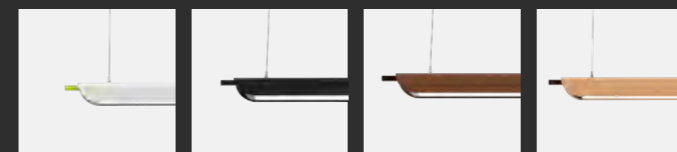

20W    28W    40W    56W

铝型材  
Aluminum profile

Page. 349

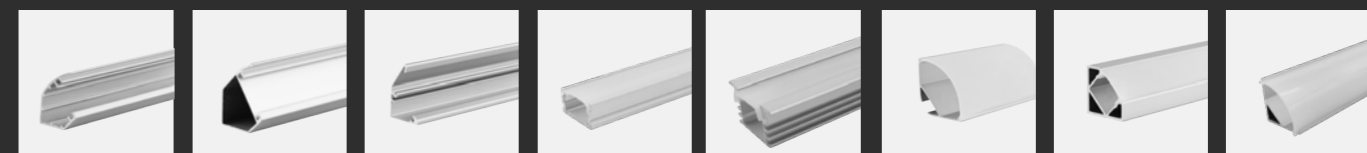

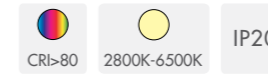

**Model 型号:** BD-LED-002-1  
**Light Source 光源:** SMD  
**Power 功率:** 15W/30W  
**Input voltage 输入电压:** AC100V-265V  
**Cut out 开孔:** 595x195mm(15W)/1195x195mm(30W)  
**Size(WxLxH) 尺寸:** 600x200x42mm(15W)/1200x200x42mm(30W)

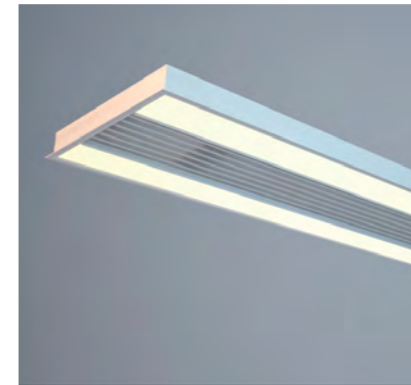

**Model 型号:** BD-LED-002-1-2  
**Light Source 光源:** SMD  
**Power 功率:** 2x15W/2x30W  
**Input voltage 输入电压:** AC100V-265V  
**Cut out 开孔:** 595x195mm(30W)/1195x195mm(60W)  
**Size(WxLxH) 尺寸:** 600x200x42mm(30W)/1200x120x42mm(60W)

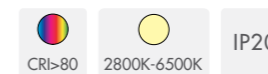

**Model 型号:** BD-LED-002-J  
**Light Source 光源:** SMD  
**Power 功率:** 15W  
**Input voltage 输入电压:** AC100V-265V  
**Cut out 开孔:** 1195x115mm  
**Size(WxLxH) 尺寸:** 1200x120x42mm



**Model 型号:** BD-LED-002-5L  
**Light Source 光源:** SMD  
**Power 功率:** 24W/m  
**Input voltage 输入电压:** AC100V-265V  
**Cut out 开孔:** ∞x95mm  
**Size(WxLxH) 尺寸:** ∞x100x42mm



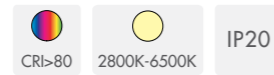

**Model 型号 :** BD-LED-001W  
**Light Source 光源 :** SMD  
**Power 功率 :** 2x12W/2x15W/2x30W  
**Input voltage 输入电压 :** AC100V-265V  
**Size(WxLxH) 尺寸 :** 450x140x40mm(24W)/600x160x40mm(30W)/1200x160x40mm(60W)

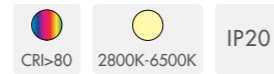

**Model 型号 :** BD-LED-001P  
**Light Source 光源 :** SMD  
**Power 功率 :** 4x15W/4x30W  
**Input voltage 输入电压 :** AC100V-265V  
**Size(WxLxH) 尺寸 :** 600x320x40mm(60W)/1200x320x40mm(120W)

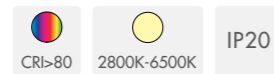

**Model 型号 :** BD-LED-001F  
**Light Source 光源 :** SMD  
**Power 功率 :** 4x15W  
**Input voltage 输入电压 :** AC100V-265V  
**Size(WxLxH) 尺寸 :** 600x460x1900mm

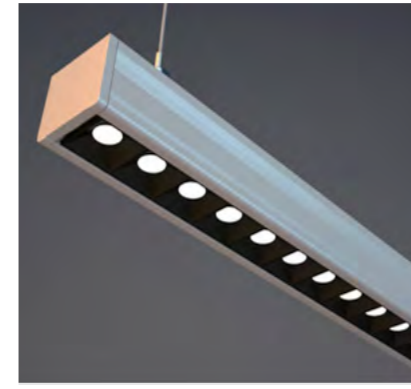

**Model 型号 :** BD-LED-003  
**Light Source 光源 :** SMD  
**Power 功率 :** down90W+up30W  
**Input voltage 输入电压 :** AC100V-265V  
**Size(WxLxH) 尺寸 :** 2400x45x45mm

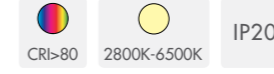
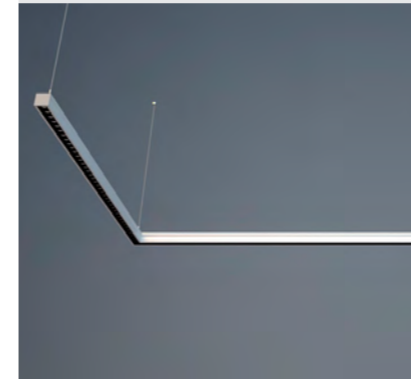

**Model 型号 :** BD-LED-003  
**Light Source 光源 :** SMD  
**Power 功率 :** down135W+up45W  
**Input voltage 输入电压 :** AC100V-265V  
**Size(WxLxH) 尺寸 :** 2400x1200x45mm

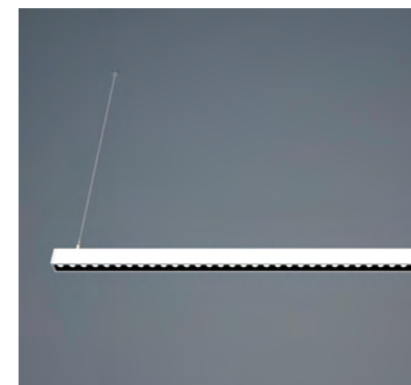

**Model 型号 :** BD-LED-003  
**Light Source 光源 :** SMD  
**Power 功率 :** down45W+up15W  
**Input voltage 输入电压 :** AC100V-265V  
**Size(WxLxH) 尺寸 :** 1200x45x45mm



**PRODUCT DATA** 产品参数

<b>Model</b> 型号:	IG-BGE06015	IG-BGE09020	IG-BGE12030	IG-BGE15045
<b>Light Source</b> 光源:	SMD	SMD	SMD	SMD
<b>Power</b> 功率:	15W	20W	30W	45W
<b>Light Output</b> 光通量:	1250 lm	1650 lm	2460 lm	3750 lm
<b>Colour</b> 颜色:	Sliver	Sliver	Sliver	Sliver
<b>Size(WxLxH)</b> 尺寸:	580 x 60 x 82mm	890 x 60 x 82mm	1180 x 60 x 82mm	1480 x 60 x 82mm







**PRODUCT DATA** 产品参数

<b>Model</b> 型号:	IG-BGB06030	IG-BGB09040	IG-BGB12060	IG-BGB15090
<b>Light Source</b> 光源:	SMD	SMD	SMD	SMD
<b>Power</b> 功率:	30W	40W	60W	90W
<b>Light Output</b> 光通量:	2400 lm	3200 lm	4800 lm	7200 lm
<b>Colour</b> 颜色:	Sliver	Sliver	Sliver	Sliver
<b>Size(WxLxH)</b> 尺寸:	580x43x132mm	890x43x132mm	1180x43x132mm	1480x43x132mm









 CRI>80
  3000K
  4000K
  6000K
  IP20





**Model 型号 :** LF-806  
**Light Source 光源 :** SMD  
**Power 功率 :** 20W  
**Input voltage 输入电压 :** DC220-240V  
**Size(WxLxH) 尺寸 :** 900x80x90mm

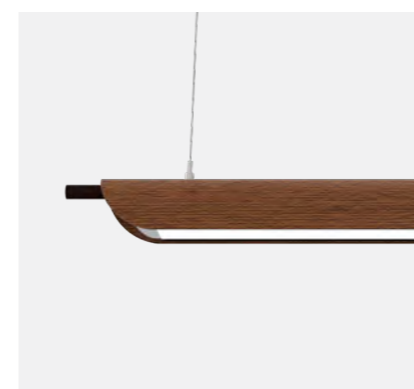

 CRI>80
  3000K
  4000K
  6000K
  IP20





**Model 型号 :** LF-806  
**Light Source 光源 :** SMD  
**Power 功率 :** 28W  
**Input voltage 输入电压 :** DC220-240V  
**Size(WxLxH) 尺寸 :** 1200x80x90mm



 CRI>80
  3000K
  4000K
  6000K
  IP20

**Model 型号 :** LF-806  
**Light Source 光源 :** SMD  
**Power 功率 :** 40W  
**Input voltage 输入电压 :** DC220-240V  
**Size(WxLxH) 尺寸 :** 1800x80x90mm



 CRI>80
  3000K
  4000K
  6000K
  IP20

**Model 型号 :** LF-806  
**Light Source 光源 :** SMD  
**Power 功率 :** 56W  
**Input voltage 输入电压 :** DC220-240V  
**Size(WxLxH) 尺寸 :** 2400x80x90mm

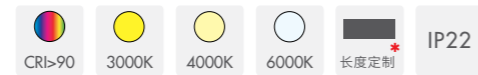
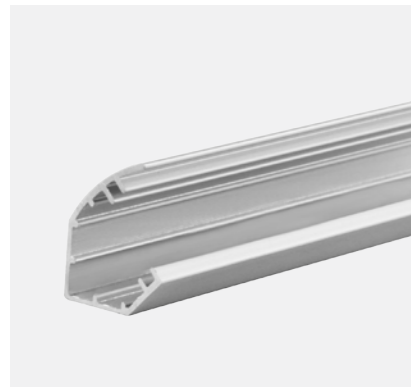

**Model 型号:** XC002114  
**Color 颜色:** 氧化铝本色  
**Temperature 工作温度:** -30°C ~50°C  
**Material 外壳材料:** 铝材 Auminum  
**Size(WxLxH) 尺寸:** 1000x20.8x14mm

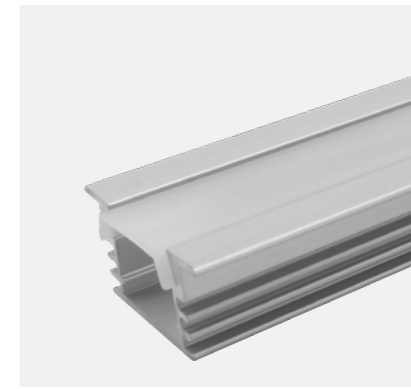
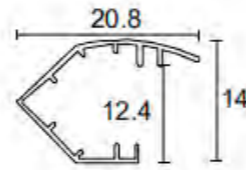

**Model 型号:** XC002412  
**Color 颜色:** 氧化铝本色  
**Temperature 工作温度:** -30°C ~50°C  
**Material 外壳材料:** 铝材 Auminum  
**Size(WxLxH) 尺寸:** 1000x23.8x12mm

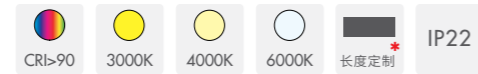
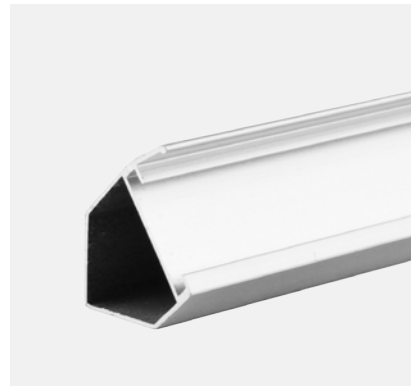
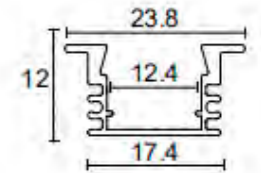

**Model 型号:** XC001520  
**Color 颜色:** 氧化铝本色  
**Temperature 工作温度:** -30°C ~50°C  
**Material 外壳材料:** 铝材 Auminum  
**Size(WxLxH) 尺寸:** 1000x14.6x20.5mm

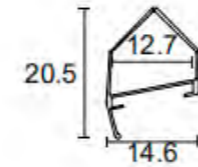

**Model 型号:** XC003030  
**Color 颜色:** 氧化铝本色  
**Temperature 工作温度:** -30°C ~50°C  
**Material 外壳材料:** 铝材 Auminum  
**Size(WxLxH) 尺寸:** 1000x29.8x29.8mm

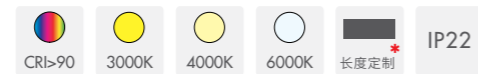
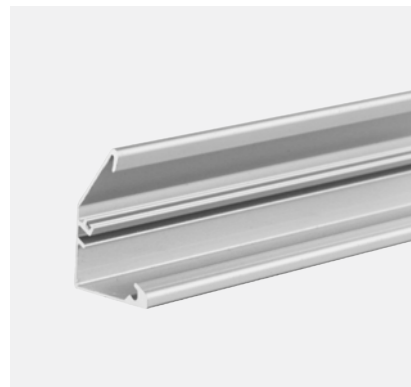
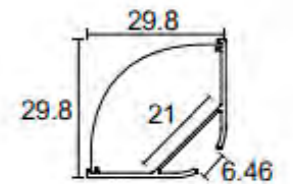

**Model 型号:** XC002014  
**Color 颜色:** 氧化铝本色  
**Temperature 工作温度:** -30°C ~50°C  
**Material 外壳材料:** 铝材 Auminum  
**Size(WxLxH) 尺寸:** 1000x13.9x20.3mm

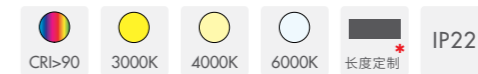
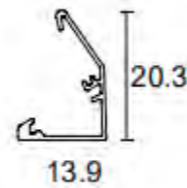

**Model 型号:** XC001818  
**Color 颜色:** 氧化铝本色  
**Temperature 工作温度:** -30°C ~50°C  
**Material 外壳材料:** 铝材 Auminum  
**Size(WxLxH) 尺寸:** 1000x18.2x18.2mm

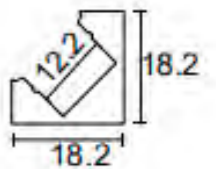

**Model 型号:** XC001407  
**Color 颜色:** 氧化铝本色  
**Temperature 工作温度:** -30°C ~50°C  
**Material 外壳材料:** 铝材 Auminum  
**Size(WxLxH) 尺寸:** 1000x14.4x6.8mm

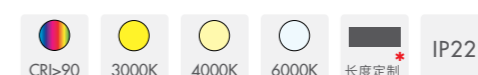
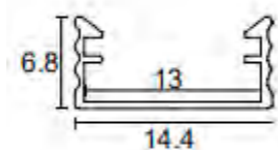

**Model 型号:** XC001616  
**Color 颜色:** 氧化铝本色  
**Temperature 工作温度:** -30°C ~50°C  
**Material 外壳材料:** 铝材 Auminum  
**Size(WxLxH) 尺寸:** 1000x15.7x15.7mm

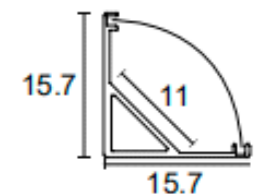

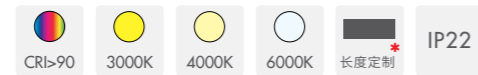

**Model 型号:** XC002109  
**Color 颜色:** 氧化铝本色  
**Temperature 工作温度:** -30°C ~50°C  
**Material 外壳材料:** 铝材 Auminum  
**Size(WxLxH) 尺寸:** 1000x20.68x8.8mm

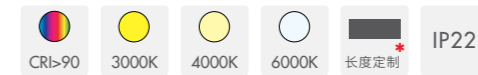
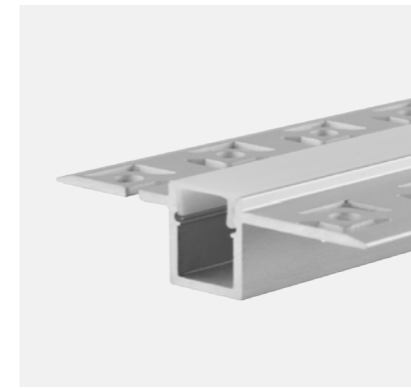
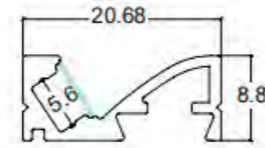

**Model 型号:** XC005314  
**Color 颜色:** 氧化铝本色  
**Temperature 工作温度:** -30°C ~50°C  
**Material 外壳材料:** 铝材 Auminum  
**Installation 安装方式:** 预埋嵌装 Recessed  
**Density 灯珠密度:** ≥120led/m(2835)  
**Size(WxLxH) 尺寸:** 1000x53x14mm

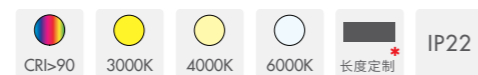
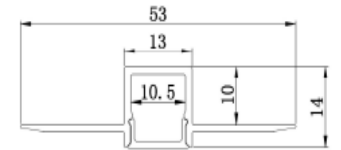

**Model 型号:** XC002409  
**Color 颜色:** 氧化铝本色  
**Temperature 工作温度:** -30°C ~50°C  
**Material 外壳材料:** 铝材 Auminum  
**Size(WxLxH) 尺寸:** 1000x23.6x8.8mm

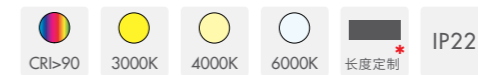
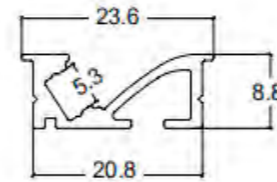

**Model 型号:** XC004316  
**Color 颜色:** 氧化铝本色  
**Temperature 工作温度:** -30°C ~50°C  
**Material 外壳材料:** 铝材 Auminum  
**Installation 安装方式:** 明装 Surface mounted  
**Density 灯珠密度:** ≥120led/m(2835)  
**Size(WxLxH) 尺寸:** 1000x42.5x16mm

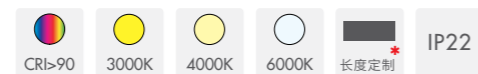
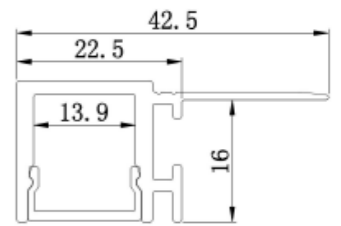

**Model 型号:** XC003014  
**Color 颜色:** 氧化铝本色  
**Temperature 工作温度:** -30°C ~50°C  
**Material 外壳材料:** 铝材 Auminum  
**Size(WxLxH) 尺寸:** 1000x30x14mm

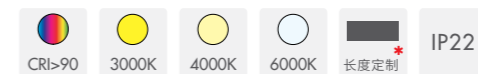
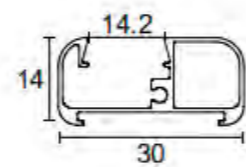

**Model 型号:** XC005022  
**Color 颜色:** 氧化铝本色  
**Temperature 工作温度:** -30°C ~50°C  
**Material 外壳材料:** 铝材 Auminum  
**Size(WxLxH) 尺寸:** 1000x50x22mm

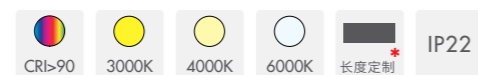
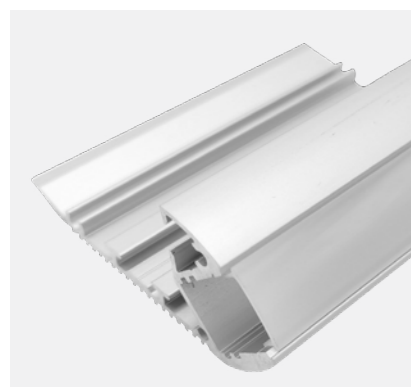
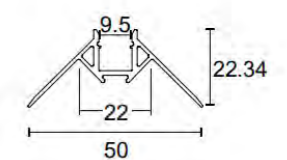

**Model 型号:** XC006627  
**Color 颜色:** 氧化铝本色  
**Temperature 工作温度:** -30°C ~50°C  
**Material 外壳材料:** 铝材 Auminum  
**Size(WxLxH) 尺寸:** 1000x66x27mm

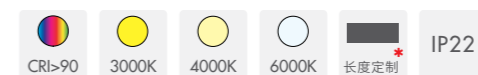
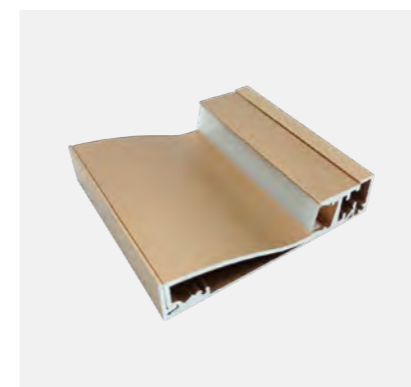
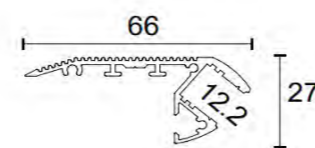

**Model 型号:** XC008016  
**Color 颜色:** 氧化铝本色  
**Temperature 工作温度:** -30°C ~50°C  
**Material 外壳材料:** 铝材 Auminum  
**Size(WxLxH) 尺寸:** 1000x80x16mm

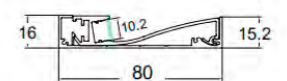



CRI>90
3000K
4000K
IP20
5M/卷



低压灯带 - 裸板

**PRODUCT DATA** 产品参数

Model 型号	Power 功率	Input voltage 输入电压	LED Amount LED 数量	Size(LxW) 尺寸
IG-DD283505 01	4.8W/M	DC12-24V	60 珠 /M	5000x8mm
IG-DD283510 01	9.6W/M	DC12-24V	120 珠 /M	5000x8mm
IG-DD283512 01	12W/M	DC12-24V	60 珠 /M	5000x10mm
IG-DD283515 01	14.4W/M	DC12-24V	180 珠 /M	5000x10mm

CRI>90
3000K
4000K
IP64
5M/卷



低压灯带 - 套管

**PRODUCT DATA** 产品参数

Model 型号	Power 功率	Input voltage 输入电压	LED Amount LED 数量	Size(LxW) 尺寸
IG-DD283505 02	4.8W/M	DC12-24V	60 珠 /M	5000x8mm
IG-DD283510 02	9.6W/M	DC12-24V	120 珠 /M	5000x8mm
IG-DD283512 02	12W/M	DC12-24V	60 珠 /M	5000x10mm
IG-DD283515 02	14.4W/M	DC12-24V	180 珠 /M	5000x10mm

CRI>90
3000K
4000K
IP67
5M/卷



低压灯带 - 灌胶

**PRODUCT DATA** 产品参数

Model 型号	Power 功率	Input voltage 输入电压	LED Amount LED 数量	Size(LxW) 尺寸
IG-DD283505 03	4.8W/M	DC12-24V	60 珠 /M	5000x10mm
IG-DD283510 03	9.6W/M	DC12-24V	120 珠 /M	5000x10mm
IG-DD283512 03	12W/M	DC12-24V	60 珠 /M	5000x12mm
IG-DD283515 03	14.4W/M	DC12-24V	180 珠 /M	5000x12mm

CRI>80
3000K
4000K
IP65
5M/卷



高压灯带

**PRODUCT DATA** 产品参数

Model 型号	Power 功率	Input voltage 输入电压	LED Amount LED 数量	Size 尺寸
IG-DD573009 01	8.5W/M	220V/110V	120 珠 /M	板宽 12mm
IG-DD283508 01	7.5W/M	220V/110V	180 珠 /M	板宽 12mm
IG-DD283506 01	6W/M	220V/110V	120 珠 /M	板宽 8mm
IG-DD283507 01	7W/M	220V/110V	72 珠 /M	板宽 6mm
IG-DD505007 01	7W/M	220V/110V	60 珠 /M	板宽 12mm

CRI>90
3000K
4000K
IP67
5M/卷



LED 柔性灯带

**PRODUCT DATA** 产品参数

Model 型号	Power 功率	Input voltage 输入电压	LED Amount LED 数量	Size(LxW) 尺寸
IG-DD101006 01	6-9W/M	DC12-24V	120 珠 /M	板宽 6mm
IG-DD041006 01	6-12W/M	DC12-24V	120 珠 /M	板宽 5mm
IG-DD1306 01	6-12W/M	DC12-24V	120 珠 /M	板宽 8mm





CRI>70
3000K
4000K
6500K
IP20
50PCS



#### PRODUCT DATA 产品参数

Model 型号	Power 功率	Luminous flux 光通量	Input voltage 输入电压	light source/Amount 光源 / 珠数	Size(L) 尺寸
IG-ZJ003005 02	5W	450 lm	AC130-265V	5730/24	300mm
IG-ZJ006010 05	10W	950 lm	AC130-265V	5730/48	600mm
IG-ZJ009015 05	15W	1400 lm	AC130-265V	5730/72	900mm
IG-ZJ010017 05	17W	1600 lm	AC130-265V	5730/80	1000mm
IG-ZJ012020 05	20W	1900 lm	AC130-265V	5730/96	1200mm

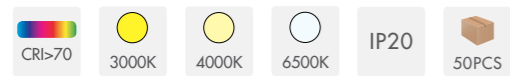

**PRODUCT DATA** 产品参数

Model 型号	Power 功率	Luminous flux 光通量	Input voltage 输入电压	light source/Amount 光源 / 珠数	Size(L) 尺寸
IG-ZJ006010 08	10W	1000 lm	AC130-265V	5730/48	600mm
IG-ZJ009015 08	15W	1500 lm	AC130-265V	5730/72	900mm
IG-ZJ012020 08	20W	2000 lm	AC130-265V	5730/96	1200mm



**PRODUCT DATA** 产品参数

Model 型号	Power 功率	Luminous flux 光通量	Input voltage 输入电压	light source/Amount 光源 / 珠数	Size(L) 尺寸
IG-ZJ006010 07	10W	1000 lm	AC130-265V	5730/48	600mm
IG-ZJ009015 07	15W	1500 lm	AC130-265V	5730/72	900mm
IG-ZJ012020 07	20W	2000 lm	AC130-265V	5730/96	1200mm



# 室内灯

## 地脚灯 Buriedground Lighting

Page. 365

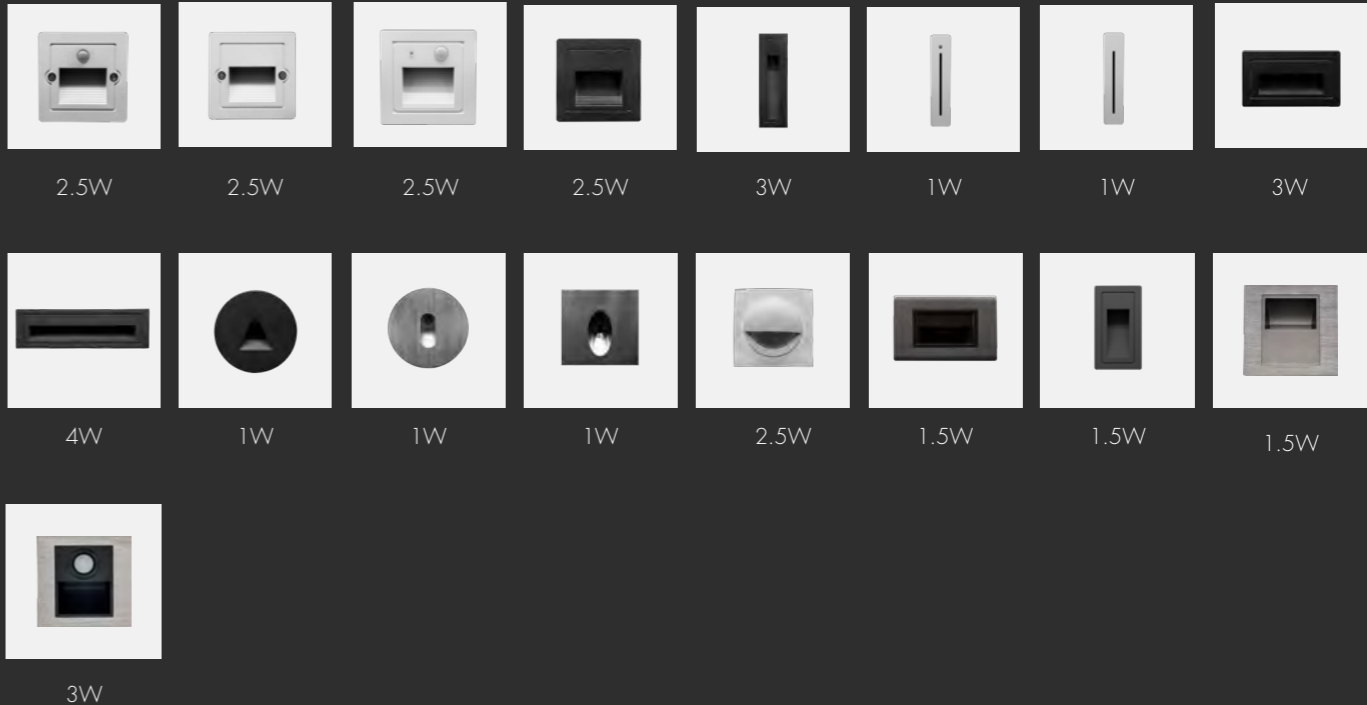

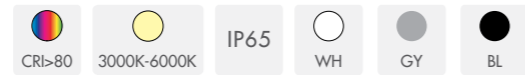

**Model 型号 :** DJ008003-03  
**Light Source 光源 :** SANAN  
**Power 功率 :** 2.5W  
**Input voltage 输入电压 :** AC85V-265V  
**Cutout 开孔尺寸 :** 80x80mm  
**Size(WxLxH) 尺寸 :** 90x90x30mm

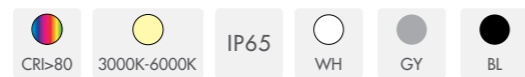

**Model 型号 :** DJ008003-01  
**Light Source 光源 :** SANAN  
**Power 功率 :** 2.5W  
**Input voltage 输入电压 :** AC85V-265V  
**Cutout 开孔尺寸 :** 80x80mm  
**Size(WxLxH) 尺寸 :** 86x86x30mm



**Model 型号 :** DJ008003-03A  
**Light Source 光源 :** SANAN  
**Power 功率 :** 2.5W  
**Input voltage 输入电压 :** AC85V-265V  
**Cutout 开孔尺寸 :** 80x80mm  
**Size(WxLxH) 尺寸 :** 95x95x30mm

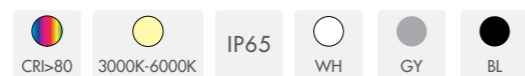

**Model 型号 :** DJ007503-01  
**Light Source 光源 :** SANAN  
**Power 功率 :** 2.5W  
**Input voltage 输入电压 :** AC85V-265V  
**Cutout 开孔尺寸 :** 75x75mm  
**Size(WxLxH) 尺寸 :** 85x85x33mm

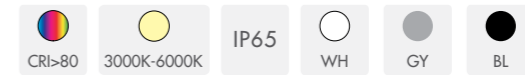

**Model 型号 :** DJ020003-01  
**Light Source 光源 :** SANAN  
**Power 功率 :** 3W  
**Input voltage 输入电压 :** AC85V-265V  
**Cutout 开孔尺寸 :** 200x55mm  
**Size(WxLxH) 尺寸 :** 210x65x60mm

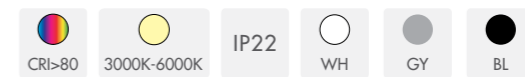
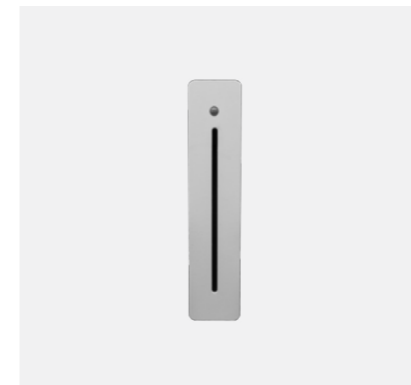

**Model 型号 :** DJ017201-03  
**Light Source 光源 :** CREE  
**Power 功率 :** 1W  
**Input voltage 输入电压 :** AC85V-265V  
**Cutout 开孔尺寸 :** 185x40mm  
**Size(WxLxH) 尺寸 :** 172x38x40mm

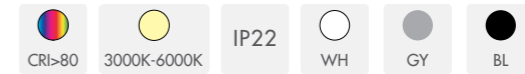
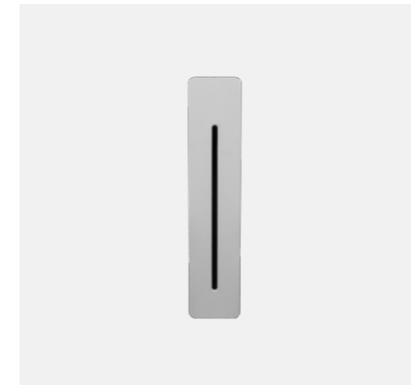

**Model 型号 :** DJ017201-01  
**Light Source 光源 :** CREE  
**Power 功率 :** 1W  
**Input voltage 输入电压 :** AC85V-265V  
**Cutout 开孔尺寸 :** 185x40mm  
**Size(WxLxH) 尺寸 :** 172x38x40mm

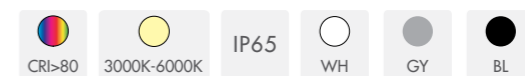

**Model 型号 :** DJ007503-02  
**Light Source 光源 :** SANAN  
**Power 功率 :** 3W  
**Input voltage 输入电压 :** AC85V-265V  
**Cutout 开孔尺寸 :** 105x75mm  
**Size(WxLxH) 尺寸 :** 115x85x50mm

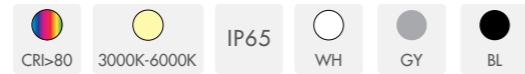

**Model 型号:** DJ020004-02  
**Light Source 光源:** SANAN  
**Power 功率:** 4W  
**Input voltage 输入电压:** AC85V-265V  
**Cutout 开孔尺寸:** 200x55mm  
**Size(WxLxH) 尺寸:** 210x65x60mm

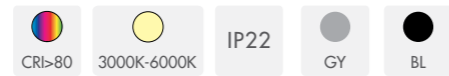
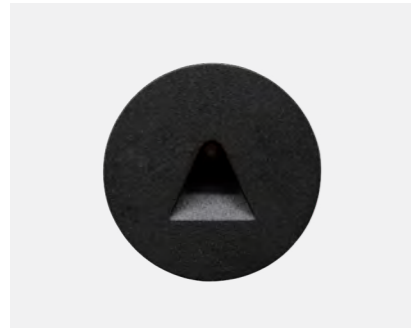

**Model 型号:** DJ004501-04  
**Light Source 光源:** SANAN  
**Power 功率:** 1W  
**Input voltage 输入电压:** AC85V-265V  
**Cutout 开孔尺寸:** Ø45mm  
**Size(DxH) 尺寸:** Ø65x30mm

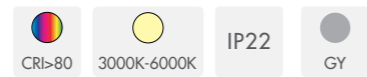
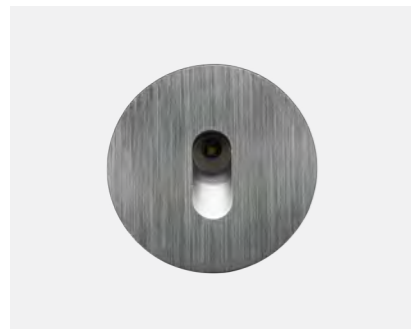

**Model 型号:** DJ004501-01  
**Light Source 光源:** SANAN  
**Power 功率:** 1W  
**Input voltage 输入电压:** AC85V-265V  
**Cutout 开孔尺寸:** Ø45mm  
**Size(DxH) 尺寸:** Ø65x30mm

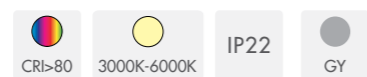
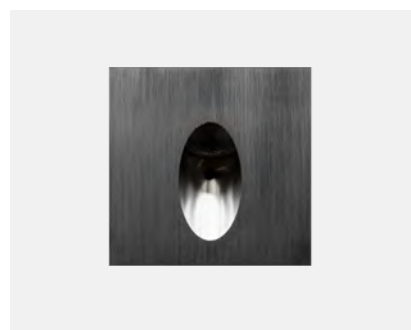

**Model 型号:** DJ004501-02  
**Light Source 光源:** SANAN  
**Power 功率:** 1W  
**Input voltage 输入电压:** AC85V-265V  
**Cutout 开孔尺寸:** 45x45mm  
**Size(WxLxH) 尺寸:** 65x65x30mm

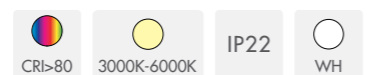

**Model 型号:** 亚克力 003/ 方  
**Light Source 光源:** SANAN  
**Power 功率:** 2.5W  
**Input voltage 输入电压:** AC85V-265V  
**Cutout 开孔尺寸:** Ø40mm  
**Size(DxH) 尺寸:** Ø60x33mm

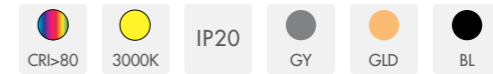
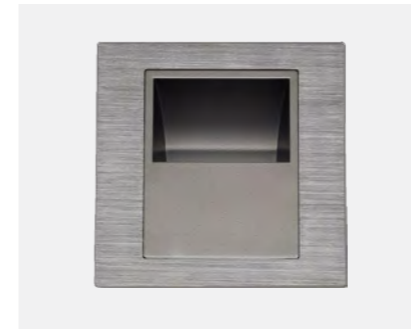

**Model 型号:** IG-DJ008002 01  
**Light Source 光源:** CREE  
**Power 功率:** 1.5W  
**Input voltage 输入电压:** AC180V-260V  
**Cutout 开孔尺寸:** 86x86mm  
**Size(WxLxH) 尺寸:** 86x86x30mm

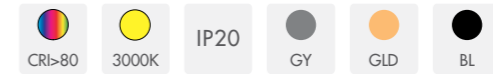
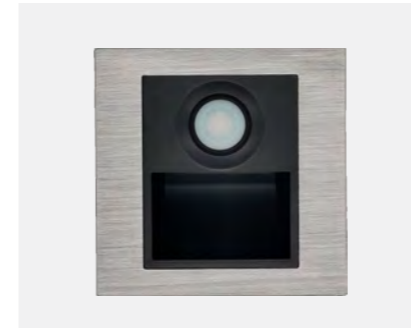

**Model 型号:** IG-DJ008602 03  
**Light Source 光源:** CREE  
**Power 功率:** 1.5W  
**Input voltage 输入电压:** AC180V-260V  
**Cutout 开孔尺寸:** 86x86mm  
**Size(WxLxH) 尺寸:** 86x86x30mm

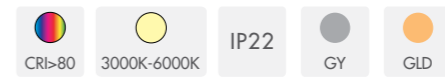

**Model 型号:** DJ011802  
**Light Source 光源:** SANAN  
**Power 功率:** 1.5W  
**Input voltage 输入电压:** AC85V-265V  
**Cutout 开孔尺寸:** 开关 118 盒  
**Size(WxL) 尺寸:** 118x75mm

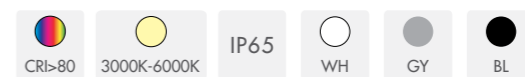

**Model 型号:** DJ009503  
**Light Source 光源:** SANAN  
**Power 功率:** 3W  
**Input voltage 输入电压:** AC85V-265V  
**Cutout 开孔尺寸:** 95x50mm  
**Size(WxLxH) 尺寸:** 105x60x60mm



# 户外灯

壁灯  
Wall lamp

Page. 372

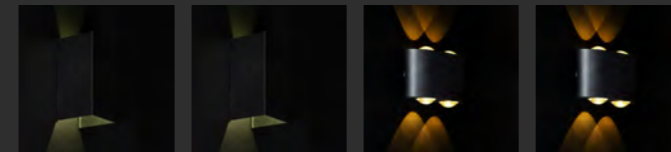

2x5W    2x10W    4x1W    6x1W

线条灯  
Line lamp

Page. 373



12W    24W    12W

线条灯  
Line lamp

Page. 374



36W/48W    12W    12W    18W/24W    12W    15W    12W

地埋灯  
Buried lamp

Page. 375



3Wx1    6Wx1    1W    2W    3W    1W

投光灯  
Flood Light

Page. 377

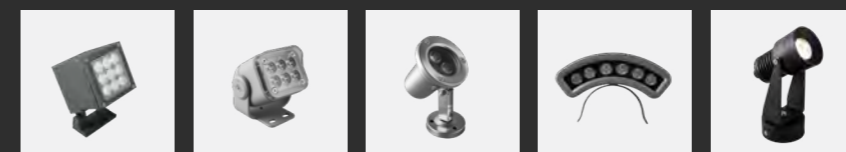

9Wx1    6Wx1    3Wx1    6Wx1    7W

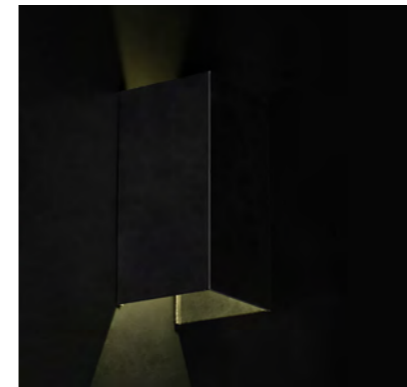

**Model 型号 :** IG-BD010010 01  
**Light Source 光源 :** COB  
**Power 功率 :** 2x5W  
**Input voltage 输入电压 :** DC24V/DC220V  
**Beam angle 光束角 :** 120°  
**Size(WxL) 尺寸 :** 100x100mm

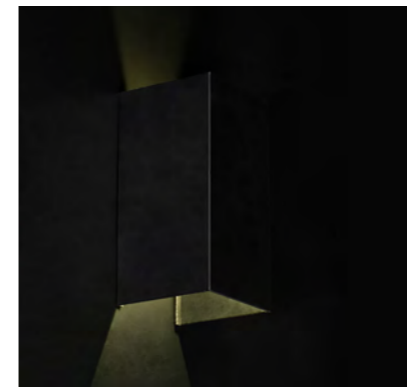

**Model 型号 :** IG-BD020020 01  
**Light Source 光源 :** COB  
**Power 功率 :** 2x10W  
**Input voltage 输入电压 :** DC24V/DC220V  
**Beam angle 光束角 :** 120°  
**Size(WxL) 尺寸 :** 200x95mm

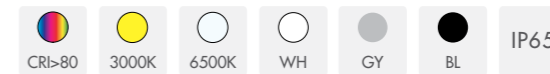
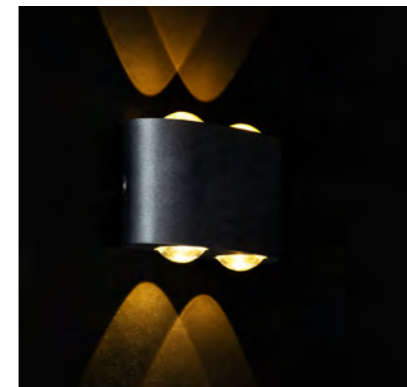

**Model 型号 :** IG-BD012504 01  
**Light Source 光源 :** COB  
**Power 功率 :** 4x1W  
**Input voltage 输入电压 :** DC24V/DC220V  
**Beam angle 光束角 :** 120°  
**Size(WxL) 尺寸 :** 125x40mm



**Model 型号 :** IG-BD017506 01  
**Light Source 光源 :** COB  
**Power 功率 :** 6x1W  
**Input voltage 输入电压 :** DC24V/DC220V  
**Beam angle 光束角 :** 120°  
**Size(WxL) 尺寸 :** 175x40mm

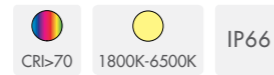

**Model 型号:** IG-XQ004212 01  
**Light Source 光源:** EPISTAR  
**Power 功率:** 12W  
**Angle 角度:** 30x60°  
**Input voltage 输入电压:** DC24V  
**Size(WxHxL) 尺寸:** 1000x45x26mm

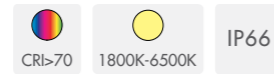

**Model 型号:** IG-XQ003612 01  
**Light Source 光源:** SMD  
**Power 功率:** 24W  
**Angle 角度:** 10x65°  
**Input voltage 输入电压:** DC24V  
**Size(WxHxL) 尺寸:** 1000x36x26mm

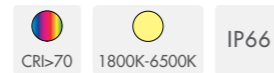

**Model 型号:** IG-XQ003212 01  
**Light Source 光源:** OSRAM  
**Power 功率:** 12W  
**Angle 角度:** 15x45°  
**Input voltage 输入电压:** DC24V  
**Size(WxHxL) 尺寸:** 1000x32x25mm

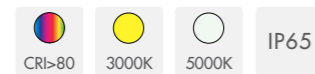

**Model 型号:** IG-XQ506036 01  
**Light Source 光源:** OSRAM  
**Power 功率:** 36W/48W  
**Angle 角度:** 60°/45°/30° /20°/15x45°  
**Input voltage 输入电压:** DC220-240V  
**Size(WxHxL) 尺寸:** 1000x50x60mm

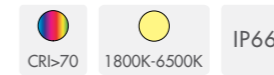

**Model 型号:** IG-XT003512 01  
**Light Source 光源:** SMD  
**Power 功率:** 12W  
**Input voltage 输入电压:** DC24V  
**Size(WxHxL) 尺寸:** 35x48x1000mm  
**Distance 串接距离:** Max-8M

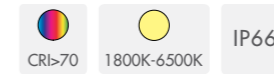

**Model 型号:** IG-XT002412 01  
**Light Source 光源:** SMD  
**Power 功率:** 12W  
**Input voltage 输入电压:** DC24V  
**Size(WxHxL) 尺寸:** 24x40x1000mm  
**Distance 串接距离:** Max-8M

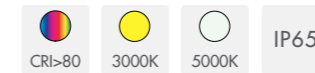

**Model 型号:** IG-XQ403024 01  
**Light Source 光源:** OSRAM  
**Power 功率:** 18W/24W  
**Angle 角度:** 60°/45°/30° /20°/15x45°  
**Input voltage 输入电压:** DC24V  
**Size(WxHxL) 尺寸:** 1000x40x30mm



**Model 型号:** IG-XQ303512 01  
**Light Source 光源:** RPILEDs  
**Power 功率:** 12W  
**Angle 角度:** 120°  
**Input voltage 输入电压:** DC24V  
**Size(WxHxL) 尺寸:** 1000x30x35mm



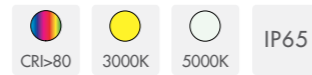
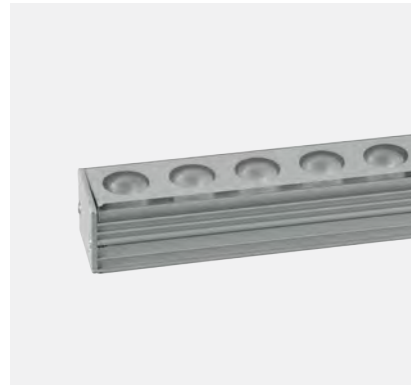

**Model 型号:** IG-XQ252515 01  
**Light Source 光源:** OSRAM  
**Power 功率:** 15W  
**Angle 角度:** 60°/45°/30° /20°/15x45°  
**Input voltage 输入电压:** DC24V  
**Size(WxHxL) 尺寸:** 1000x25x25mm



**Model 型号:** IG-XQ304512 01  
**Light Source 光源:** RPILEDs  
**Power 功率:** 12W  
**Angle 角度:** 1w  
**Input voltage 输入电压:** DC24V  
**Size(WxHxL) 尺寸:** 1000x30x45mm

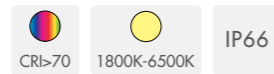

**Model 型号:** IG-DM010003 01  
**Light Source 光源:** OSRAM  
**Power 功率:** 3x1W  
**Angle 角度:** 10°/15°/25°/30°/45°/60°  
**Input voltage 输入电压:** DC24V  
**Cutout 开孔尺寸:** Ø95mm  
**Size(DxH) 尺寸:** Ø100x75mm



**Model 型号:** IG-DM013006 02  
**Light Source 光源:** OSRAM  
**Power 功率:** 6x1W  
**Angle 角度:** 10°/15°/25°/30°/45°/60°  
**Input voltage 输入电压:** DC24V  
**Cutout 开孔尺寸:** Ø130mm

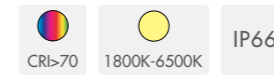

**Model 型号:** IG-DM004201 01  
**Light Source 光源:** OSRAM  
**Power 功率:** 1W  
**Angle 角度:** 15°/24°/36°  
**Input voltage 输入电压:** DC24V  
**Size(DxH) 尺寸:** Ø42x70mm

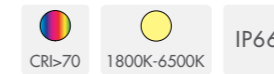

**Model 型号:** IG-DM006202 01  
**Light Source 光源:** OSRAM  
**Power 功率:** 2W  
**Angle 角度:** 15°/24°/36°  
**Input voltage 输入电压:** DC24V  
**Size(DxH) 尺寸:** Ø62x90mm

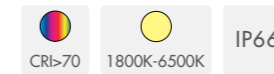

**Model 型号:** IG-DM005203 01  
**Light Source 光源:** OSRAM  
**Power 功率:** 3W  
**Angle 角度:** 10°/15°/25°/30°/45°/60°  
**Input voltage 输入电压:** DC24V  
**Cutout 开孔尺寸:** Ø48mm  
**Size(DxH) 尺寸:** Ø52x80mm

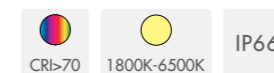

**Model 型号:** IG-DM002701 01  
**Light Source 光源:** OSRAM  
**Power 功率:** 1W  
**Angle 角度:** 15°/24°/36°  
**Input voltage 输入电压:** DC24V  
**Cutout 开孔尺寸:** Ø27mm



CRI>70 1800K-6500K IP66

**Model 型号 :** IG-TG009509 01  
**Light Source 光源 :** OSRAM  
**Power 功率 :** 9x1W  
**Angle 角度 :** 15°/25°/30°/45°/60°  
**Input voltage 输入电压 :** 220V/DC24V  
**Size(WxLxH) 尺寸 :** 95x95x105mm



CRI>70 1800K-6500K IP66

**Model 型号 :** IG-TG005006 01  
**Light Source 光源 :** OSRAM  
**Power 功率 :** 6x1W  
**Angle 角度 :** 30°  
**Input voltage 输入电压 :** DC24V  
**Size(WxLxH) 尺寸 :** 50x63x70mm



CRI>70 1800K-6500K IP66

**Model 型号 :** IG-TG006203 01  
**Light Source 光源 :** OSRAM  
**Power 功率 :** 3x1W  
**Angle 角度 :** 30°  
**Input voltage 输入电压 :** DC24V  
**Cutout 开孔尺寸 :** Ø82mm



CRI>70 1800K-6500K IP66

**Model 型号 :** IG-WL021006 01  
**Light Source 光源 :** OSRAM  
**Power 功率 :** 6x1W  
**Angle 角度 :** 30°  
**Input voltage 输入电压 :** DC24V  
**Size(WxH) 尺寸 :** 210x55mm

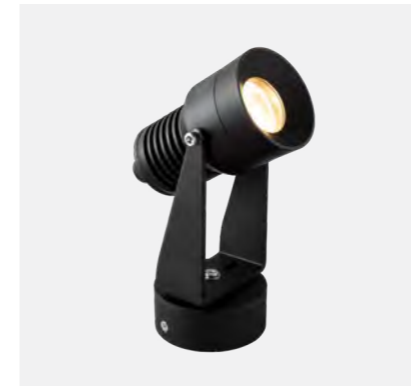

CRI>70 1800K-6500K IP66

**Model 型号 :** IG-CD008007 01  
**Light Source 光源 :** CREE COB  
**Power 功率 :** 7W  
**Angle 角度 :** 20°/35°  
**Input voltage 输入电压 :** 220V  
**Size(DxH) 尺寸 :** Ø80x140mm+ 预埋件 210mm





#### 市场应用:

钻石珠宝首饰、手机、水晶、古玩、翡翠和工艺品等重点展示照明、艺术厅、壁画、酒吧酒水柜、精品橱窗等照明的场所。

#### Applications:

Diamond jewelry, mobile phone, crystal, antiques, jadeite and crafts and other places that focus on lighting, art hall, mural, bar wine cabinet, boutique window and other lighting.

#### 产品特性描述:

1. 运用小角度点光源对物品进行多点多角度照射，发出最诱人的光芒；
2. 冷光源，不会对所照物品产生热辐射，确保商品不受热伤害；
3. 寿命长，工作电压低，使用安全可靠；
4. 功耗极低，环保省电；
5. 采用高纯度光扩散材质，精工制造；
6. 灯光无频闪，使人的眼睛不会产生疲劳；

#### Product Features:

1. Use the small angle point light source to irradiate the object from multiple points and angles to give out the most attractive light.
2. The cold light source will not produce heat radiation to the illuminated goods, so as to ensure that the goods will not be damaged by heat.
3. Long service life, low working voltage, safe and reliable use.
4. Low power consumption, environmental protection and power saving.
5. It is made of high-purity light diffusion material and precision manufacturing.
6. There is no stroboscopic light, so that people's eyes will not be tired.

# 橱柜灯

#### 橱柜灯

#### Cabinet Lights



8W

18W

4W

9W

1W

2W

4W

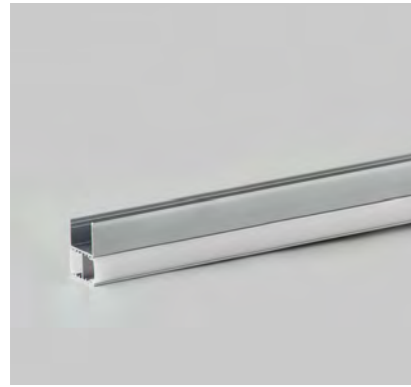

**Model 型号:** ZJ00292008 01  
**Light Source 光源:** SMD  
**Power 功率:** 8W  
**Input voltage 输入电压:** DC12V  
**Switching mode 开关方式:** 触摸感应 / 手扫感应 / 门碰感应 / 人体感应  
**Size(WxLxH) 尺寸:** 564x29x20mm (可夹 16-18mm 的木板)

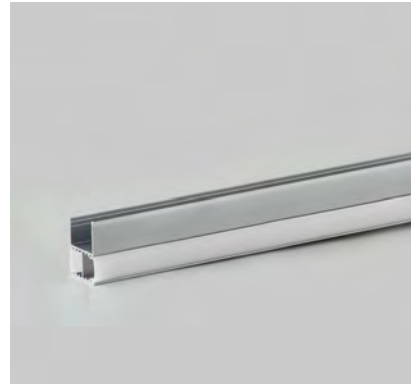

**Model 型号:** ZJ00292018 01  
**Light Source 光源:** SMD  
**Power 功率:** 18W  
**Input voltage 输入电压:** DC12V  
**Switching mode 开关方式:** 触摸感应 / 手扫感应 / 门碰感应 / 人体感应  
**Size(WxLxH) 尺寸:** 1064x29x20mm (可夹 16-18mm 的木板)



**Model 型号:** ZJ00173004 01  
**Light Source 光源:** SMD  
**Power 功率:** 4W  
**Input voltage 输入电压:** DC12V  
**Switching mode 开关方式:** 触摸感应 / 手扫感应 / 门碰感应 / 人体感应  
**Size(WxLxH) 尺寸:** 564x16.6x30mm (可夹 10-12mm 的玻璃灯)



**Model 型号:** ZJ00173009 01  
**Light Source 光源:** SMD  
**Power 功率:** 9W  
**Input voltage 输入电压:** DC12V  
**Switching mode 开关方式:** 触摸感应 / 手扫感应 / 门碰感应 / 人体感应  
**Size(WxLxH) 尺寸:** 1064x16.6x30mm(可夹 10-12mm 的玻璃灯)



**Model 型号:** XQ00480901 01  
**Light Source 光源:** SMD  
**Power 功率:** 1W  
**Input voltage 输入电压:** DC12V  
**Switching mode 开关方式:** 手扫感应 / 人体感应  
**Size(WxLxH) 尺寸:** 300x48x8.4mm



**Model 型号:** XQ00480902 01  
**Light Source 光源:** SMD  
**Power 功率:** 2W  
**Input voltage 输入电压:** DC12V  
**Switching mode 开关方式:** 手扫感应 / 人体感应  
**Size(WxLxH) 尺寸:** 500x48x8.4mm



**Model 型号:** XQ00480904 01  
**Light Source 光源:** SMD  
**Power 功率:** 4W  
**Input voltage 输入电压:** DC12V  
**Switching mode 开关方式:** 手扫感应 / 人体感应  
**Size(WxLxH) 尺寸:** 1000x48x8.4mm



# 新型智能控制开关



## BLE Mesh控制技术

- 1.通用协议安全性高
- 2.安装简易, 操控便捷
- 3.手拉手式, 网状链接, 同步性高
- 4.分段调节, 记忆功能
- 5.场景一键控制
- 6.支持单/多联开关控制
- 7.综合性价比高
- 8.穿墙性弱

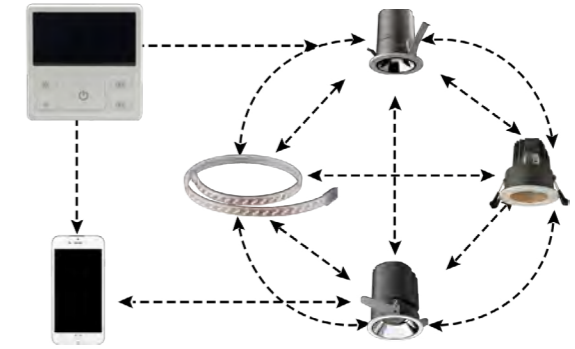

链式智能系统: 自组网无线技术, 手拉手式互联, 大大增强组建智能网络的范围。与手机互联互通、标准协议、可以接入AI系统。

蓝牙调光调色 (或单调光) 恒流电源	内、外置 94 × 45 × 28mm	输入 200-240Vac	输出 DC: 28-40V	150mA ± 5%	6W	
				200mA ± 5%	8W	
				250mA ± 5%	10W	
				300mA ± 5%	12W	
				350mA ± 5%	15W	
	外置 168 × 45 × 30mm 内置 113 × 45 × 30mm	输入 200-240Vac	输出 DC: 28-40V	400mA ± 5%	16.5W	
				450mA ± 5%	18W	
				500mA ± 5%	20W	
				550mA ± 5%	22.5W	
				600mA ± 5%	25W	
蓝牙调光调色 (或单调光) 恒压电源	85 × 45 × 23mm	输入 DC12V/24V	DC: 12V/24V	5A	12V:60W/24V:120W	
				15A	12V:180W/24V:360W	
情景面板/调光 调色开关面板	86 × 86 × 13mm					

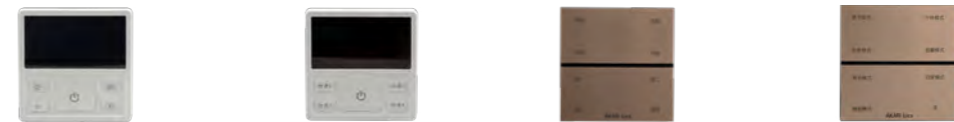

### 效果展示

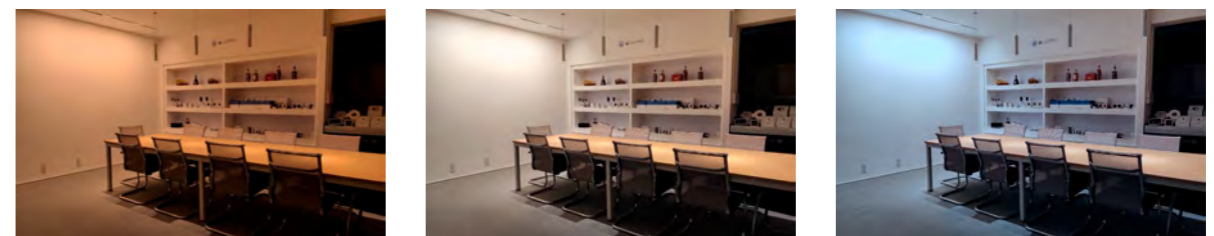

色温调节

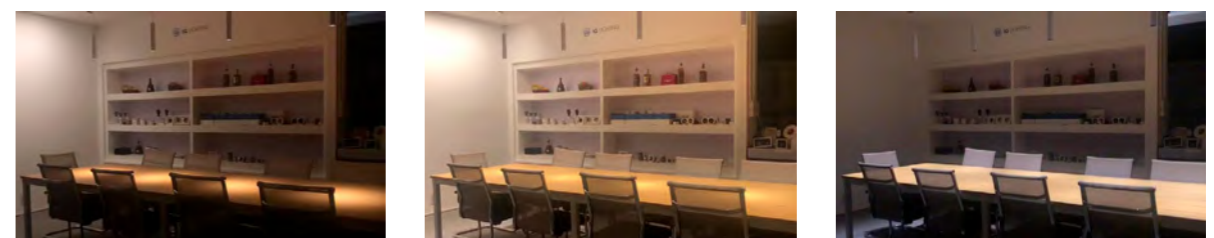

场景控制

## 产品应用操作

### 无源无线开关

- 1.光能转电能
- 2.转换效率高, 待机时间长
- 3.分段调节, 记忆功能
- 4.场景一键控制
- 5.支持多联开关控制



### APP与使用说明下载



### 开关操作说明



**APP配对模式:**  
USB通电状态下, 按下b~f任一按键, 指示灯h亮表示处于app配对模式

**恢复出厂设置:**  
USB通电状态下, 同时按下b和f键, 指示灯h快速闪烁, 则实现开关恢复出厂设置功能。

**注: 开关对灯具进行控制时需断开USB供电, 否则控制无效。**



**APP配对模式:**  
USB通电状态下, 按下b~f任一按键, 指示灯h亮表示处于app配对模式

**恢复出厂设置:**  
USB通电状态下, 同时按下b和f键, 指示灯h快速闪烁, 则实现开关恢复出厂设置功能。

**注: 开关对灯具进行控制时需断开USB供电, 否则控制无效。**

### 固定面板

- 1.分段调节, 记忆功能
- 2.场景一键控制
- 3.支持多联开关控制;

### APP与使用说明下载

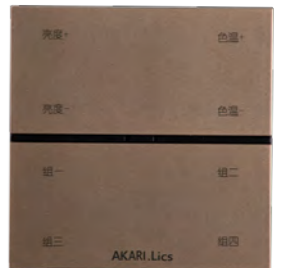

### 开关操作说明

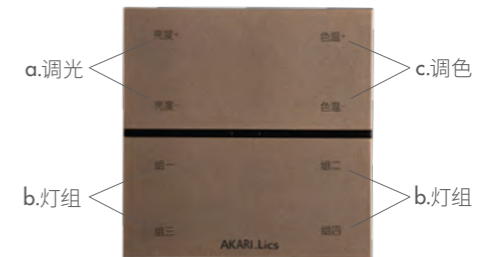
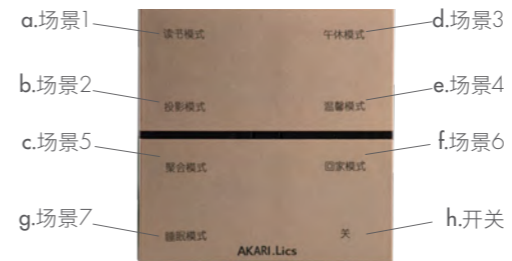

有线智能控制系统：

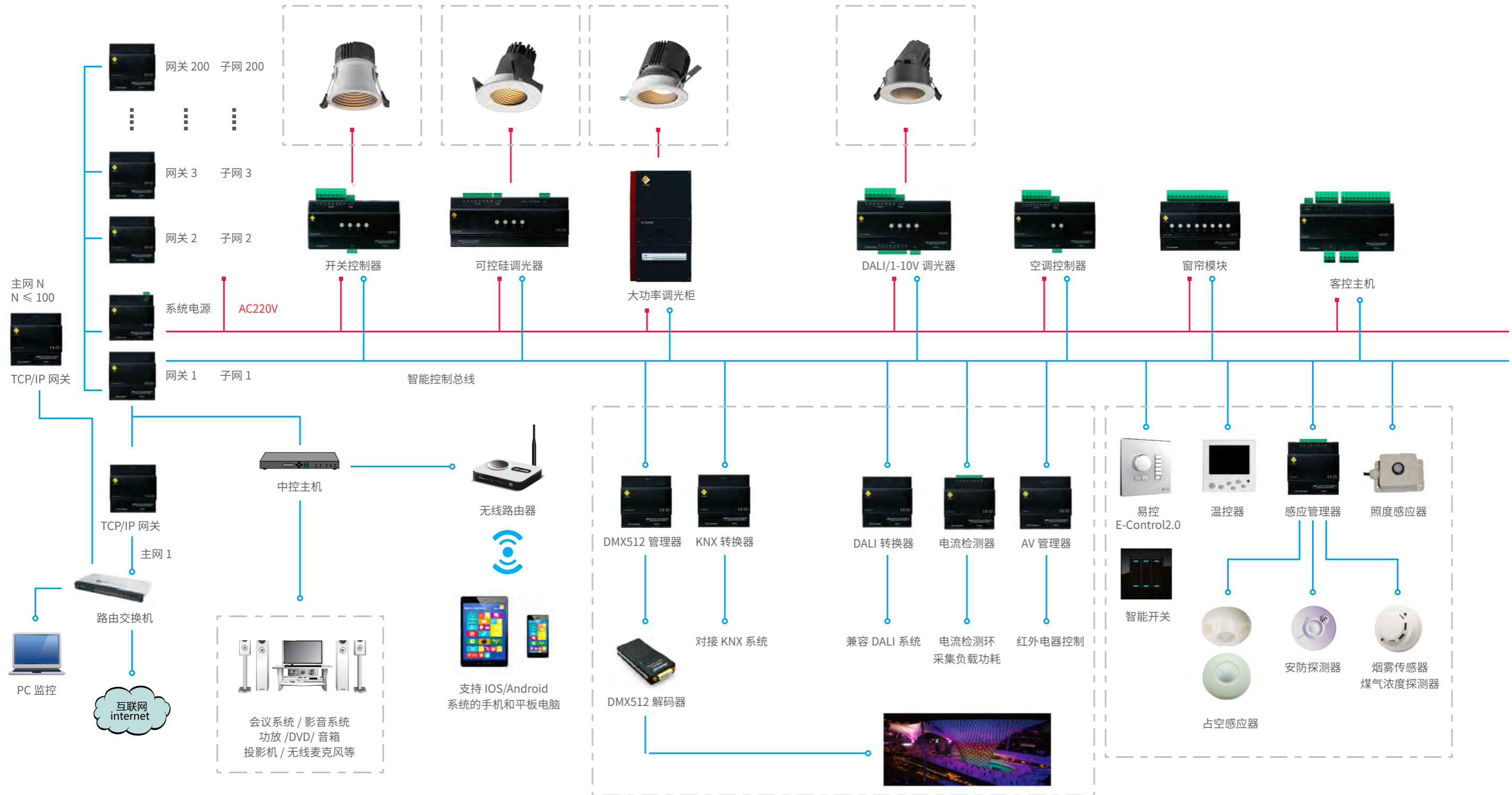

可控硅系统调光：

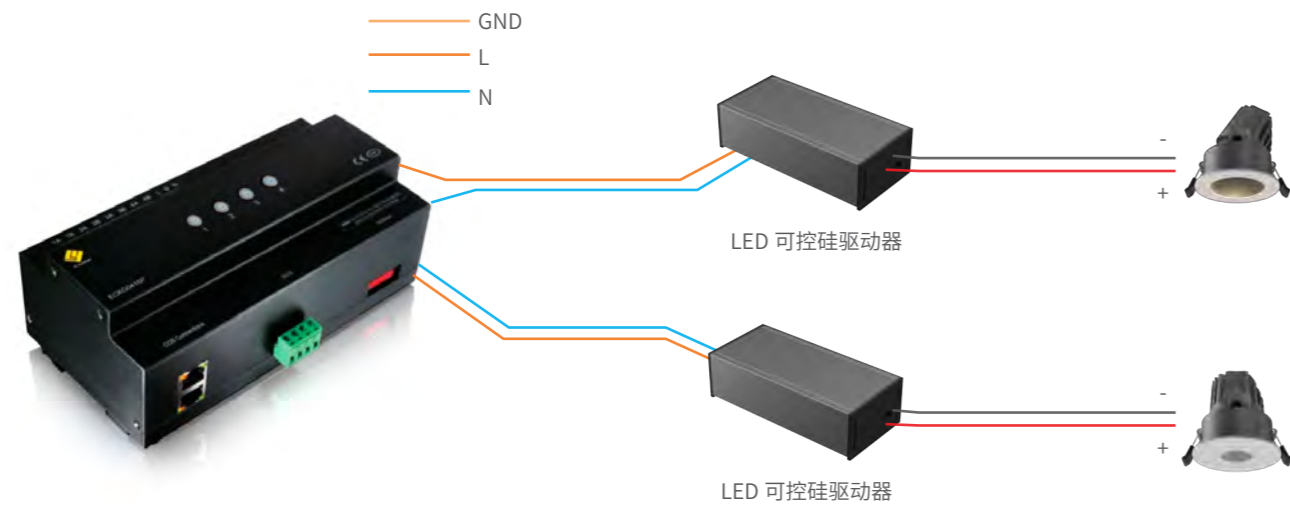

0-10V 调光拓扑图：

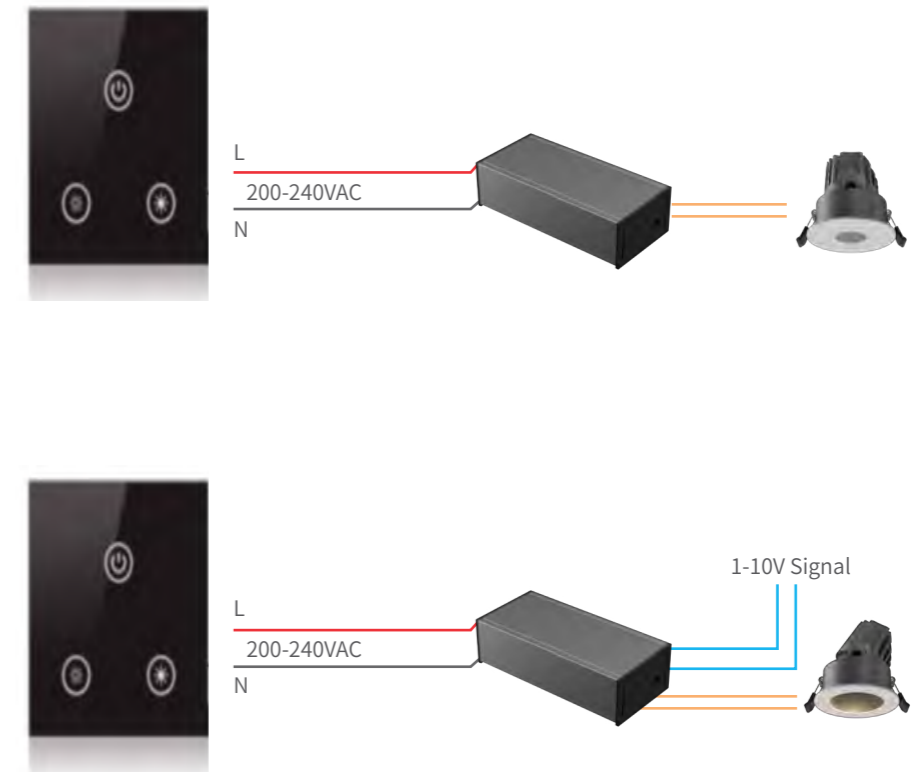

0-10V 系统调光：

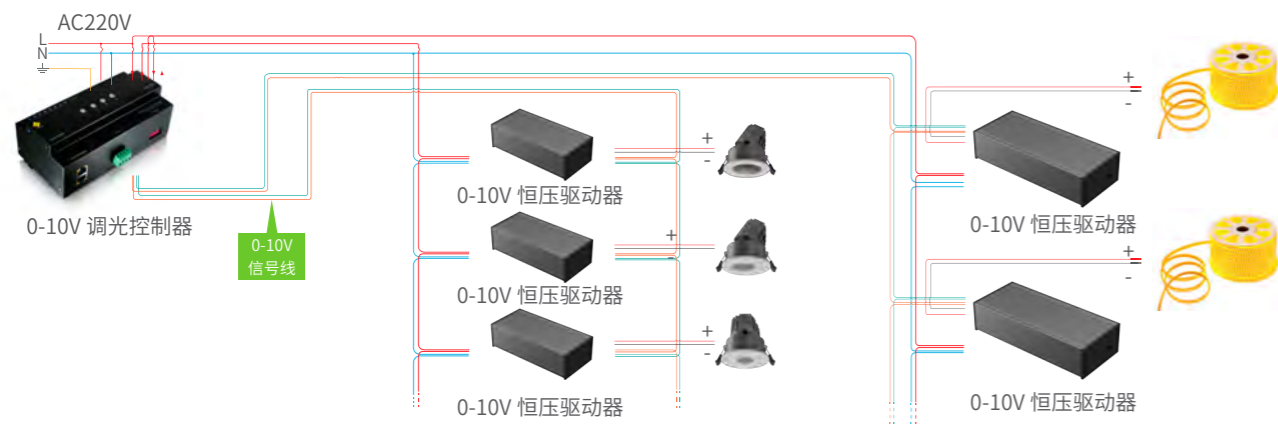

TRIAC 调光拓扑图：  
可控硅开关调光：

